



ENGLISH



ESPAÑOL

**Koken** TOOL CO., LTD.

**2013**



# 2013 INDEX

Reproduction in whole or in part without proper and prior authorization is prohibited.

*Se prohíbe la reproducción total o parcial sin la debida autorización previa.*

Specifications or design of any product in this catalogue are subject to change without notice.

*Las especificaciones o el diseño de cualquiera de los productos de este catálogo están sujetos a cambio sin previo aviso.*

## HAND SOCKET MANUALES

P20-116



## Z-SERIES

P118-126



## TITANIUM DE TITANIO

P128



## ACCESSORIES ACCESORIOS

P130-162



SCREWDRIVERS  
DESTORNILLADORES

P164-168



AUTOMOTIVE

P242-262



IMPACT  
DE IMPACTO

P170-224



CONSTRUCTION  
CONSTRUCCIÓN

P264-274



SLEEVE-DRIVE

P226-234



RENEWAL KITS

JUEGOS DE PIEZAS DE REPUESTO

P276-279



INDUSTRIAL  
INDUSTRIALES

P236-240



HAND  
MANUALES  
Z-SERIES  
TITANIUM  
DE TITANIO  
ACCESSORIES  
ACCESORIOS  
SCREWDRIVERS  
DESTORNILLADORES  
IMPACT  
DE IMPACTO  
SLEEVE-DRIVE  
INDUSTRIAL  
INDUSTRIALES  
AUTOMOTIVE  
CONSTRUCTION  
CONSTRUCCION  
RENEWAL KITS  
JUEGOS DE PIEZAS REPUESTO







## ■ TEST AND LABORATORY



Ko-ken uses a variety of test equipment. Strength is measured by the Static Load Test Machine that can measure torque load up to 5,000Nm. Durability is measured by the Cyclic Test Machine and corrosion resistance testing is done by the Salt Spray Test Machine. The test results are used to improve our standard products and assist with new product design and development.



## ■ DESIGN AND DEVELOPMENT

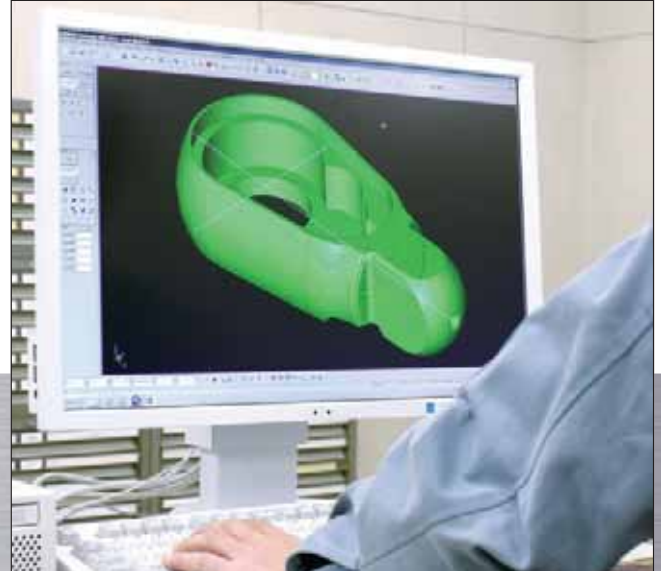

The 3D-CAD is used to improve standard products, designing new products and making customized items for special requirements. Trial products are regularly developed, manufactured and tested to improve the durability, appearance and functionality of all tools produced by Ko-ken.



## ■ FORGING



The Forging machines are used for the forging process. These machines can produce mass quantities of sockets and parts with high accuracy that ordinary drop forging machines can not achieve. However, for small production runs, ordinary forging machines are also used.



## ■ TURNING



The forged steel is turned into required shapes and dimensions. The MC (Machining Center) operates with extraordinary speed and precision. The article number, size, logo, production number, and MADE IN JAPAN are marked on the products after the turning process has been completed.



## ■ HEAT TREATMENT



To make the tools stronger and more durable, proper heat treatment is critically important. The temperature and the time of the heat treatment are strictly regulated by a very accurate control device.



## ■ INSPECTION



Our products are periodically checked at each production process by inspection devices. Highly accurate 3-D measuring instruments are used to inspect and confirm dimensions.







## FLAT DRIVE®



Flat Drive is designed to guarantee a flat surface contact between the socket and the bolt/nut. The Flat contact reduces wear and allows to transmit a higher torque value. The Flat Drive System is also used for the square drive end as well as the hexagonal or bi-hexagonal openings of the socket.

El diseño de Contacto Plano garantiza una superficie de contacto plana entre el vaso y el perno/tuerca. El contacto plano reduce el desgaste y permite transmitir un par mayor. El Sistema de Contacto Plano se utiliza tanto para el extremo del cuadrado conductor como para la boca hexagonal o bi-hexagonal del vaso.

# SOCKETS



## NUT GRIP®



Twin balls at the 6-point opening hold bolt/nut tightly for safe and reliable work.

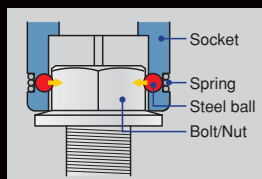

El perno/tuerca se sujeta firmemente por medio de dos bolas en la boca hexagonal para un trabajo seguro y fiable.

## SURFACE DRIVE



Surface drive sockets are designed to retain contact with flat sides of nut to transmit high torque and reduce nut wear.

These sockets are ideal for use on polished nuts, aluminum nuts and nuts with worn out points.

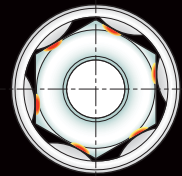

Los vasos de contacto curvo se diseñan para mantener el contacto con las caras planas de la tuerca y transmitir un alto par reduciendo el desgaste de la tuerca.

Estos vasos son ideales para utilizarse en tuercas pulidas, tuercas de aluminio y tuercas con puntas desgastadas.

## PATHFINDER®



The beveled flats of the 6-point opening of the PATHFINDER socket engage the nut almost immediately. PATHFINDER sockets are ideal for use with power tools in automatic assembly processes, as the power tool does not have to be totally stopped for the socket to engage the nut.

Las caras biseladas de la boca hexagonal del vaso GUÍA acoplan el vaso inmediatamente.

Los vasos GUÍA son ideales para su utilización con herramientas mecánicas en procesos de montaje automáticos, ya que no es necesario que la herramienta esté completamente parada para acoplar el vaso a la tuerca.







# RATCHET HANDLE



## S.O.D.H-System®

Two dogs are located in the ratchet body so that the dogs and springs are held securely in place while allowing the reversing lever and dog to switch smoothly.

The torque load on the gear it is transmitted vertically to the dog, and in turn, down the ratchet handle. This mechanism locks gears tightly in place while torque is being applied, thus avoiding any gear slippage.

Los dos trinquetes del cuerpo de la llave de carraca y sus muelles están dispuestos en el cuerpo de la llave de forma que se mantienen firmemente en posición permitiendo un cambio suave de la palanca de inversión y del trinquete.

El par sobre la rueda dentada se transmite verticalmente al trinquete, y al mismo tiempo al mango de la llave de carraca. Este mecanismo bloquea firmemente los dientes mientras se aplica el par, evitando así el deslizamiento de los mismos.



## Two-Step Dog

Two flats hold two teeth of the ratchet gear, thus increasing the maximum torque load of the ratchet compared with a single-step system.

Los dientes de la rueda de la llave de carraca se inmovilizan por medio de dos dientes aumentando de esta forma el par máximo de la llave en comparación con el sistema de un paso.



## Three-Step Dog

Two dogs are set in the same axis, and the three teeth hold the ratchet gear.

The enlarged contact area produces about 10% higher torque value and the S.O.D.H-System provides smooth and light movements.

Se disponen dos trinquetes en el mismo eje y la rueda de la llave de carraca se bloquea por medio de tres dientes.

El aumento de la superficie de contacto produce un aumento de par de aproximadamente 10% y el sistema S.O.D.H permite movimientos suaves y sin esfuerzo.



## SHAPE of HANDLE



## OVAL SHAPE SHANK



Unique designed oval shape shank provides extra strength and durability.

El particular diseño de caña de sección Ovalada proporciona más resistencia y duración.

## KNURLING

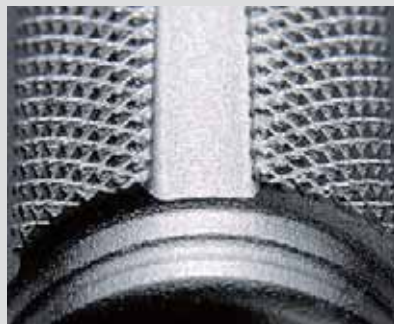

Ratchets and Hinge handles have knurling on the grip to ensure the tool can be held securely.

Extension bars also have 6-point knurling on the outside of the female square drive. This gives a grip to hold with your fingers as well as preventing the tool from rolling on flat surfaces.



## WOBBLE-FIX



One use as a flexible extension bar permitting movement up to 15° angle and the other as a normal extension bar.

Una, como alargadera flexible que permite trabajar con un ángulo de 15°, otra, como alargadera normal.

Fix



Wobble

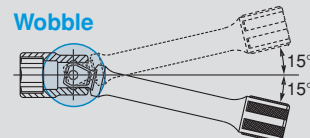





# STUD BOLT PULLER/SETTER

## STUD BOLT PULLER



The body design was changed to hexagonal shape to minimize tolerances. This shape is also effective to lessen excessive load on cages and rollers inside the body.



## RATCHET PULLER



Puller for tightening stud bolts. Go-through body allows puller to grip the stud bolt at any position along the stud. Three-roller protects the bolt from damage.



## STUD BOLT SETTER



Special socket for installing a stud bolt. The bolt contacts with a steel ball to prevent the bolt from sticking onto the socket. After installing the bolt, turn anti-clockwise to remove the socket.

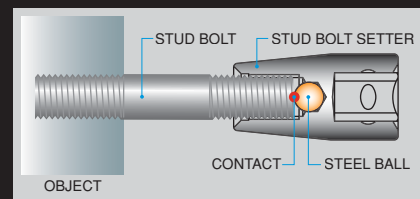



# ATTACK DRIVER®

## 1 BLACK FINISHED HEAD

The top of Attack Driver is manganese phosphate treated to prevent chrome peeling off the head when it is struck.



## 2 BODY SHAPE

Original body shape allows stronger grip. It makes it easier to convert the striking power into twisting power.



## 1 3 HEAT TREATMENT FOR ANTI-CRACK

Special Heat treatment is applied on the parts of Attack Driver. Hardness of Striking head is slightly softer to prevent cracking. The cam part has higher hardness to improve anti-wear.

## 3 SPRING

Strong spring is used to convert the striking power efficiently into twisting power.





## FREE-TURN GRIP

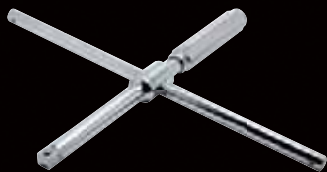

### SPINNING CROSS WRENCH

The shaft of cross wrench turns freely within the knurled grip. The cross bar is removable for easy storage in a compact space.



### FLEXIBLE SPEEDER

Free-turn grip allows speedy removal or replacement of wheel nuts. It can also be used as a hinge handle to tighten or loosen the nuts.



### SPINNING SLIDE T-HANDLE

The knurled grip is attached in the middle of shaft for free turning. Oval shaped cross bar prevents the bar from turning inside the shaft during use.





# IMPACT WHEEL NUT SOCKET



## PLASTIC PROTECTOR

A detachable plastic protector is fitted to the socket to prevent damage to the wheel when working in tight areas. The socket size and Ko-ken Mark printed on the shaft makes it easier to see if the socket is still rotating or stopped.

## EXTRA THIN-WALLED



Thin-walled shape and 110mm length gives extra reach for nuts recessed deep inside the wheel. They are ideal for aluminum wheel nuts where access to nut is very tight. Color coded shafts make size identification easy.

# SPARK PLUG SOCKET

## CLIP TYPE

It is designed to grip a spark plug securely at its hexagonal part by two stainless spring clips. Internal brass guide holds the clips in place ensuring perfect alignment of the spark plug into the threaded plughole of the cylinder head and thus preventing thread damage. The brass guide also eliminates stress loading and possible damage to the ceramic insulator.

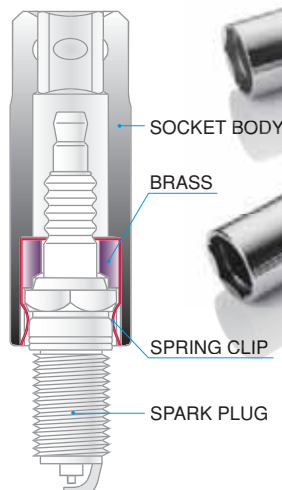

License

**TORX® / TORX<sup>plus</sup>® & LHSTIX®**

**TORX® / TORX<sup>plus</sup>®** and **LHSTIX®** are recognized as three of the most efficient fastening systems because of their ability to transfer greater torque, reduce end load and virtually eliminate tool slippage.

**TORX® / TORX<sup>plus</sup>®** y **LHSTIX®** están reconocidos como los tres sistemas más efectivos de fijación debido a su mayor capacidad de transmitir par, reducir el par final y eliminar completamente el deslizamiento de la herramienta.

**TORX® & TORX plus®**

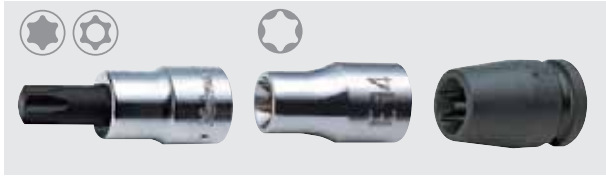

**TORX®** and **TORX<sup>plus</sup>®** are registered trademark of Acument Intellectual Properties, LLC. **Koken TOOL CO., LTD.** holds the official license to use the trademark **TORX®** and **TORX<sup>plus</sup>®**.  
**TORX®** y **TORX<sup>plus</sup>®** es una marca registrada de Acument Intellectual Properties, LLC. **Koken TOOL CO., LTD.** cuenta con licencias oficiales para el uso de la marca **TORX®** y **TORX<sup>plus</sup>®**.

**LHSTIX®**



Line Head Straight  
**LH-S series**

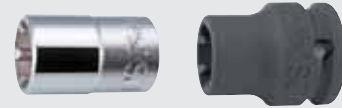

**LHSTIX®** is a registered trademark of **OSG CORPORATION** System Engineering Department. **Koken TOOL CO., LTD.** holds the official license to use the trademark **LHSTIX®**.  
**LHSTIX®** es una marca registrada de **OSG CORPORATION** System Engineering Department. **Koken TOOL CO., LTD.** cuenta con licencia oficial para uso de la marca **LHSTIX®**.

Registered Trademarks

**Koken®**



**Ko-ken® CO-KEN®**

**Koken TOOL CO., LTD.®**

HIGH PERFORMANCE TOOLS OF CONVINCING QUALITY

**山下工業研究所®**

**山下工研®**

**S.O.D.H-System®**

**Flatdrive®**

**ATTACK DRIVER®**

**HANDY-ENDY®**

**PATHFINDER®**

**Nut Grip®**

**LOCK NUT BUSTER®**

**NUT TWISTER®**

**BOLT TWISTER®**

## Aerial Photograph



## Warranty

### WARRANTY

The trade mark **Koken** is your unqualified warranty against any defect in material or workmanship. Each **Koken** tool is built to more than meet the requirements of its intended use and is carefully checked before leaving the factory. Any **Koken** tool which fails because of defective material or workmanship will be repaired or replaced through your **Koken** dealer, to the exclusion of any further liability.

### GARANTIA

La marca **Koken** es la garantía incondicional contra cualquier defecto de materiales o de fabricación. Todas las herramientas **Koken** están fabricadas para satisfacer con creces las exigencias del uso previsto y se inspeccionan meticulosamente antes de su expedición. Las herramientas **Koken** que fallen por defectos de materiales o de fabricación se repararán o reemplazarán a través del distribuidor **Koken** correspondiente, excluyendo cualquier otra responsabilidad.

## ISO9001









**SAFETY  
ADVISER**



---

## GENERAL / CONSIDERACIONES GENERALES

---

- (a) Make sure you use the right type socket, whose opening fit the nut.  
Asegurarse de utilizar el tipo de vaso adecuado, con una boca que se ajuste a la tuerca.
- (b) For use on electric or air IMPACT Wrenches select IMPACT Sockets only.  
Con llaves mecánicas de IMPACTO, utilizar solamente Vasos de IMPACTO.
- (c) When using nut runners or IMPACT Wrenches wear safety goggles.  
Cuando se utilicen aprieta-tuercas mecánicos o llaves de IMPACTO, llevar siempre gafas de seguridad.
- (d) Plastic or rubber handles are not intended to act as insulation.  
Los mangos de goma o de plástico no están previstos para aislamiento
- (e) Never substitute a HAND Socket for an INDUSTRIAL Socket or an IMPACT Socket, or an INDUSTRIAL Socket for an IMPACT Socket.  
No sustituir nunca un vaso INDUSTRIALES o un vaso de IMPACTO por un vaso MANUAL, ni un vaso de IMPACTO por un vaso INDUSTRIALES.
- (f) Items in this catalogue marked  can be loaded to torque values which may cause breakage. In the interest of your own safety always apply load evenly and progressively to avoid breakage and possible injury.  
Los artículos de este catálogo marcados  se pueden forzar con pares que pueden causar rotura. En interés de su propia seguridad aplicar siempre el par uniforme y progresivamente para evitar la rotura y posibles lesiones.

---

## SOCKETS / VASOS

---

Sockets showing cracked walls, battered points or other marks of wear are to be replaced.

Los vasos que presenten paredes agrietadas, cantos machacados u otros signos de desgaste deben reemplazarse.

---

## HANDLES / MANGOS

---

A ratchet is not a hammer  
Una llave de carraca no es un martillo.

Never use loose pipes or other improvised attachments on handles for increased leverage.

No utilizar nunca tubos sueltos u otras herramientas improvisadas con los mangos para aumentar el brazo de palanca.

---

## EXTENSION BARS / ALARGADERAS

---

The combination of several short extensions instead of one correct sized one is to be avoided.

Debe evitarse combinar varias alargaderas cortas en lugar de una sola alargadera de longitud correcta.

---

## ADAPTORS / ADAPTADORES

---

Adaptors are to be used reasonably. Be reminded that high torque potentials are reached when using a "down" adaptor, a bigger sized handle to a smaller drive socket. Always stay within safe limits.

Los adaptadores se deben utilizar razonablemente. Debe tenerse en cuenta que al utilizar adaptadores "para menor diámetro", mayor mango en un vaso conductor más pequeño, se consiguen pares superiores al necesario. Mantenerse siempre dentro de límites seguros.

**Koken®**

# Hand Sockets

1/4"

3/8"

1/2"

3/4"

1"



# Hand Sockets 1/4"

HAND MANUALES  
Z-SERIES  
TITANIUM DE TITANIO  
ACCESSORIES ACCESORIOS  
SCREWDRIVERS DESTORNILLADORES  
IMPACT DE IMPACTO  
SLEEVE-DRIVE  
INDUSTRIAL INDUSTRIALES  
AUTOMOTIVE  
CONSTRUCTION CONSTRUCCION  
RENEWAL KITS JUEGOS DE PIEZAS REPLUESTO

## 2400M • 2400A 6-point Sockets Vasos Hexagonales

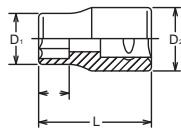

2400M 2405M (mm)	D <sub>1</sub> (mm)	D <sub>2</sub> (mm)	(mm)	L (mm)	(g)	(pcs.)
3	5.5	11.2	2.6	22	7	10
4	6.7	11.2	3.5	22	8	10
4.5	7.3	11.2	4	22	8	10
5	8	11.2	5	22	8	10
5.5	8.5	11.2	5.5	22	9	10
6	9.2	11.2	5.5	22	9	10
7	10.3	11.2	6	22	9	10
8	11.2	11.7	6.9	22	11	10
9	13	12	7.3	22	12	10
10	14.3	12.9	7.7	22	15	10
11	15.5	14.3	9.3	22	18	10
12	16.8	15.5	9.3	22	23	10
13	18	16.4	9.8	22	23	10
14	19.3	17.9	11	24	30	10

## 2405M • 2405A 12-point Sockets Vasos Bihexagonales

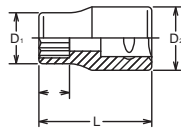

2400A 2405A (inch)	D <sub>1</sub> (mm)	D <sub>2</sub> (mm)	(mm)	L (mm)	(g)	(pcs.)
1/8	5.7	11.2	2.7	22	7	10
5/32	6.7	11.2	3.5	22	8	10
3/16	7.8	11.2	5	22	8	10
7/32	8.5	11.2	5.5	22	9	10
1/4	9.6	11.2	5.8	22	9	10
9/32	10.3	11.2	6	22	9	10
5/16	11.2	11.7	6.9	22	11	10
11/32	12.5	11.7	7.3	22	12	10
3/8	13.7	12.5	7.7	22	15	10
7/16	15.5	14.3	9.3	22	18	10
1/2	18	16.4	9.8	22	23	10
9/16	19.3	17.9	11	24	30	10

## RS2400M/11 Socket Set on Rail Juego de Vasos en Regleta

## RS2405M/11



RS2400M/11	11 Pieces Set/Rail 200mm	(g)
4, 5, 6, 7, 8, 9, 10, 11, 12, 13, 14		222

RS2405M/11	11 Pieces Set/Rail 200mm	(g)
4, 5, 6, 7, 8, 9, 10, 11, 12, 13, 14		222

## RS2400A/9 Socket Set on Rail Juego de Vasos en Regleta

## RS2405A/9



RS2400A/9	9 Pieces Set/Rail 150mm	(g)
3/16, 7/32, 1/4, 9/32, 5/16, 11/32, 3/8, 7/16, 1/2		162

RS2405A/9	9 Pieces Set/Rail 150mm	(g)
3/16, 7/32, 1/4, 9/32, 5/16, 11/32, 3/8, 7/16, 1/2		162



# 1/4" Hand Sockets

AS2405A (inch)	D <sub>1</sub> (mm)	D <sub>2</sub> (mm)	(mm)	L (mm)	(g)	(pcs.)
3/16	7.7	10.9	4.5	22	8	10
7/32	8.5	10.9	4.9	22	8	10
1/4	9.4	10.9	5.3	22	8	10
9/32	10.2	10.9	5.5	22	8	10
5/16	11.3	11.7	6.4	22	10	10
11/32	12.5	12	6.8	22	10	10
3/8	13.7	12.9	6.8	22	13	10
7/16	15.6	14.3	8.8	22	17	10
1/2	17.2	16.4	8.9	22	20	10
9/16	18.8	17.9	9.1	24	27	10

Aerospace Standard SAE AS954  
Norma Aeroespacial SAE AS954

RSAS2405A/10	10 Pieces Set/Rail 150mm	(g)
3/16, 7/32, 1/4, 9/32, 5/16, 11/32, 3/8, 7/16, 1/2, 9/16		160

2410M (mm)	D <sub>1</sub> (mm)	D <sub>2</sub> (mm)	(mm)	L (mm)	(g)	(pcs.)
4	6.7	11.2	3.5	22	8	10
4.5	7.3	11.2	4	22	8	10
5	8	11.2	5	22	8	10
5.5	8.5	11.2	5.5	22	9	10
6	9.2	11.2	5.5	22	9	10
7	10.3	11.2	6	22	9	10
8	11.2	11.7	6.9	22	11	10
9	13	12	7.3	22	12	10
10	14.3	12.9	7.7	22	15	10
11	15.5	14.3	9.3	22	18	10
12	16.8	15.5	9.3	22	23	10
13	18	16.4	9.8	22	23	10
14	19.3	17.9	11	24	30	10

RS2410M/11	11 Pieces Set/Rail 200mm	(g)
4, 5, 6, 7, 8, 9, 10, 11, 12, 13, 14		222

2400W (BA)	D <sub>1</sub> (mm)	D <sub>2</sub> (mm)	(mm)	L (mm)	(g)	(pcs.)
8	6.1	11.2	3	22	7	10
7	7.3	11.2	4	22	8	10
6	8	11.2	5	22	8	10
5	8.5	11.2	5.5	22	9	10
4	9.6	11.2	5.8	22	9	10
3	10.3	11.2	6	22	9	10
2	11.2	11.7	6.9	22	11	10
1	13	12	7.3	22	12	10
0	14.9	13.6	8	22	16	10

BA



BA		8BA	7BA	6BA	5BA	4BA	3BA	2BA	1BA	0BA
Across Flat	(ref. mm)	3.86	4.37	4.90	5.59	6.30	7.16	8.23	9.27	10.49
	(ref. inch)	0.152	0.172	0.193	0.220	0.248	0.282	0.324	0.365	0.413

RS2400W/9-BA	9 Pieces Set/Rail 150mm	(g)
8, 7, 6, 5, 4, 3, 2, 1, 0		120

## AS2405A

12-point Sockets, AS954  
Vasos Bihexagonales

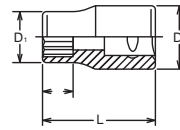

## RSAS2405A/10

Socket Set on Rail  
Juego de Vasos en Regleta



## 2410M

Surface Drive Sockets  
Vasos Surface Drive (de Contacto Curvo)

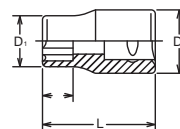

## RS2410M/11

Socket Set on Rail  
Juego de Vasos en Regleta



## 2400W-BA

6-point Sockets  
Vasos Hexagonales

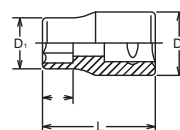

## RS2400W/9-BA

Socket Set on Rail  
Juego de Vasos en Regleta



HAND  
MANUALES

Z-SERIES

TITANIUM  
DE TITANIO

ACCESSORIES  
ACCESORIOS

SCREWDRIVERS  
DESTORNILLADORES

IMPACT  
DE IMPACTO

SLEEVE-DRIVE

INDUSTRIAL  
INDUSTRIALES

AUTOMOTIVE

CONSTRUCTION  
CONSTRUCCION

RENEWAL KITS  
JUEGOS DE PIEZAS REPUESTO

# Hand Sockets 1/4"

HAND  
MANUALES

Z-SERIES

TITANIUM  
DE TITANIO

ACCESSORIES  
ACCESORIOS

SCREWDRIVERS  
DESTORNILLADORES

IMPACT  
DE IMPACTO

SLEEVE-DRIVE

INDUSTRIAL  
INDUSTRIALES

AUTOMOTIVE

CONSTRUCTION  
CONSTRUCCION

RENEWAL KITS  
JUEGOS DE PIEZAS/REPLISTO

## 2415M • 2415A

 Double Square Sockets  
Vasos Octagonales

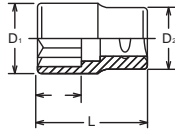

2415M (mm)	D <sub>1</sub> (mm)	D <sub>2</sub> (mm)	(mm)	L (mm)	(g)	(pcs.)
6	11	11.7	5.4	22	13	10
8	14.3	12.9	6.8	22	17	10
10	17.4	16	8.2	22	27	10

2415A (inch)	D <sub>1</sub> (mm)	D <sub>2</sub> (mm)	(mm)	L (mm)	(g)	(pcs.)
1/4	11	11.7	5.4	22	14	10
5/16	14.3	12.9	6.8	22	17	10
3/8	17.4	16	8.2	22	26	10

## 2425

 TORX® Sockets  
Vasos TORX®

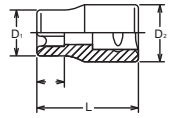

2425 (E)	D <sub>1</sub> (mm)	D <sub>2</sub> (mm)	(mm)	L (mm)	(g)	(pcs.)
E 4	5.4	11.2	4.6	22	7	10
E 5	6.7	11.2	5.2	22	8	10
E 6	7.7	11.2	5.4	22	8	10
E 7	8.3	11.2	6.6	22	9	10
E 8	9.6	11.2	7	22	9	10
E10	11.3	12	8.2	22	10	10

## RS2425/6

 Socket Set on Rail  
Juego de Vasos en Regleta



RS2425/6	6 Pieces Set/Rail 150mm	(g)
E4, E5, E6, E7, E8, E10		85

## 2450MS

 Nut Grip Sockets Nut Grip®  
Vasos Sujeta-tuercas Nut Grip®

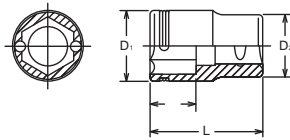

2450MS (mm)	D <sub>1</sub> (mm)	D <sub>2</sub> (mm)	(mm)	L (mm)	(g)	(pcs.)
7	11.3	11.2	4	18	8	10
8	12.3	11.2	5	18	9	10
10	14.3	12.9	6	19	13	10
12	17.4	16	7	20	22	10
13	18	16.4	8	20	22	10
14	19.9	18	8.5	22	31	10

## RS2450MS/6

 Socket Set on Rail  
Juego de Vasos en Regleta



RS2450MS/6	6 Pieces Set/Rail 150mm	(g)
7, 8, 10, 12, 13, 14		120

## 2300X

 6-point Sockets, Semi-Deep  
Vasos Hexagonales, Medianos

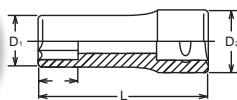

2300X (mm)	D <sub>1</sub> (mm)	D <sub>2</sub> (mm)	(mm)	L (mm)	(g)	(pcs.)
4	6.7	11.2	4	32	10	10
5	8	11.2	5.5	32	11	10
6	9.2	11.2	7	32	12	10
7	10.3	11.2	8	32	13	10
8	11.2	11.7	9	32	16	10
9	13	12	10	32	18	10
10	14.3	12.9	11	32	23	10
11	15.5	14.3	12	32	27	10
12	16.8	15.5	13	32	29	10
13	18	16.4	14	32	32	10
14	19.3	17.9	16	32	37	10

## RS2300X/11

 Socket Set on Rail  
Juego de Vasos en Regleta



RS2300X/11	11 Pieces Set/Rail 200mm	(g)
4, 5, 6, 7, 8, 9, 10, 11, 12, 13, 14		300

# 1/4" Hand Sockets

2300M 2305M (mm)	D <sub>1</sub> (mm)	D <sub>2</sub> (mm)	(mm)	L (mm)	(g)	(pcs.)
3	5.5	11.2	3	50	15	10
4	6.7	11.2	4	50	15	10
4.5	7.3	11.2	4.5	50	15	10
5	8	11.2	5.5	50	17	10
5.5	8.5	11.2	6	50	17	10
6	9.2	11.2	7	50	20	10
7	10.3	11.2	8	50	25	10
8	11.2	11.7	9	50	25	10
9	13	12	10	50	30	10
10	14.3	12.9	11	50	34	10
11	15.5	14.3	12	50	43	10
12	16.8	15.5	13	50	50	10
13	18	16.4	14	50	52	10
14	19.3	17.9	16	50	57	10

2300A 2305A (inch)	D <sub>1</sub> (mm)	D <sub>2</sub> (mm)	(mm)	L (mm)	(g)	(pcs.)
1/8	5.7	11.2	3.5	50	15	10
5/32	6.7	11.2	4	50	15	10
3/16	7.8	11.2	5.5	50	17	10
7/32	8.5	11.2	6	50	17	10
1/4	9.6	11.2	7	50	25	10
9/32	10.3	11.2	8	50	25	10
5/16	11.2	11.7	9	50	25	10
11/32	12.5	11.7	10	50	30	10
3/8	13.7	12.5	11	50	34	10
7/16	15.5	14.3	12	50	43	10
1/2	18	16.4	14	50	52	10
9/16	19.3	17.9	16	50	57	10

RS2300M/11	11 Pieces Set/Rail 200mm	(g)
4, 5, 6, 7, 8, 9, 10, 11, 12, 13, 14		437

RS2305M/11	11 Pieces Set/Rail 200mm	(g)
4, 5, 6, 7, 8, 9, 10, 11, 12, 13, 14		437

RS2300A/9	9 Pieces Set/Rail 150mm	(g)
3/16, 7/32, 1/4, 9/32, 5/16, 11/32, 3/8, 7/16, 1/2		296

RS2305A/9	9 Pieces Set/Rail 150mm	(g)
3/16, 7/32, 1/4, 9/32, 5/16, 11/32, 3/8, 7/16, 1/2		296

2300W (BA)	D <sub>1</sub> (mm)	D <sub>2</sub> (mm)	l (mm)	L (mm)	(g)	(pcs.)
4	9.8	12	7	50	25	10
3	10.9	12	8	50	25	10
2	11.6	12	9	50	25	10
1	13	12	10	50	30	10
0	15.1	13.5	12	50	38	10

BA



BA		8BA	7BA	6BA	5BA	4BA	3BA	2BA	1BA	0BA
Across Flat	(ref. mm)	3.86	4.37	4.90	5.59	6.30	7.16	8.23	9.27	10.49
	(ref. inch)	0.152	0.172	0.193	0.220	0.248	0.282	0.324	0.365	0.413

## 2300M · 2300A 6-point Deep Sockets Vasos Hexagonales Largos

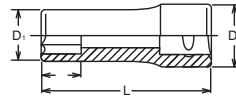

## 2305M · 2305A 12-point Deep Sockets Vasos Bihexagonales Largos

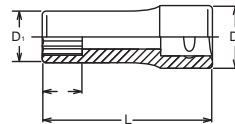

## RS2300M/11 Socket Set on Rail Juego de Vasos en Regleta

## RS2305M/11



## RS2300A/9 Socket Set on Rail Juego de Vasos en Regleta

## RS2305A/9



## 2300W-BA 6-point Deep Sockets Vasos Hexagonales Largos

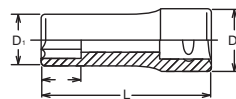

HAND MANUALES  
Z-SERIES  
TITANIUM DE TITANIO  
ACCESSORIES ACCESORIOS  
SCREWDRIVERS DESTORNILLADORES  
IMPACT DE IMPACTO  
SLEEVE-DRIVE INDUSTRIAL INDUSTRIALES  
AUTOMOTIVE  
CONSTRUCTION CONSTRUCCION  
RENEWAL KITS JUEGOS DE PIEZAS REPIESTO



# Hand Sockets 1/4"

HAND MANUALES  
Z-SERIES  
TITANIUM DE TITANIO  
ACCESSORIES ACCESORIOS  
SCREWDRIVERS DESTORNILLADORES  
IMPACT DE IMPACTO  
SLEEVE-DRIVE  
INDUSTRIAL INDUSTRIALES  
AUTOMOTIVE  
CONSTRUCTION CONSTRUCCION  
RENEWAL KITS JUEGOS DE PIEZAS REPLÉSTO

## AS2305A

12-point Deep Sockets, AS954  
Vasos Bihexagonales Largos, AS954

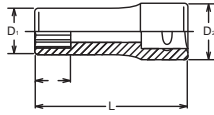

AS2305A (inch)	D <sub>1</sub> (mm)	D <sub>2</sub> (mm)	(mm)	L (mm)	(g)	(pcs.)
3/16	7.7	10.9	4.5	50	17	10
7/32	8.5	10.9	4.9	50	17	10
1/4	9.4	10.9	5.3	50	19	10
9/32	10.2	10.9	5.5	50	18	10
5/16	11.3	11.7	6.4	50	23	10
11/32	12.5	12	6.8	50	24	10
3/8	13.7	12.8	6.8	50	31	10
7/16	15.6	14.2	8.8	50	38	10
1/2	17.2	16.2	8.9	50	42	10
9/16	18.8	17.1	9.1	50	47	10

Aerospace Standard SAE AS954  
Norma Aeroespacial SAE AS954

## RSAS2305A/10

Socket Set on Rail  
Juego de Vasos en Regleta



RSAS2305A/10	10 Pieces set/Rail 150mm	(g)
3/16, 7/32, 1/4, 9/32, 5/16, 11/32, 3/8, 7/16, 1/2, 9/16		307

## 2310M

Surface Drive Deep Sockets  
Vasos Surface Drive (de Contacto Curvo) Largos

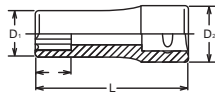

2310M (mm)	D <sub>1</sub> (mm)	D <sub>2</sub> (mm)	(mm)	L (mm)	(g)	(pcs.)
3	5.5	11.2	3	50	15	10
4	6.7	11.2	4	50	15	10
4.5	7.3	11.2	4.5	50	15	10
5	8	11.2	5.5	50	17	10
5.5	8.5	11.2	6	50	17	10
6	9.2	11.2	7	50	20	10
7	10.3	11.2	8	50	25	10
8	11.2	11.7	9	50	25	10
9	13	12	10	50	30	10
10	14.3	12.9	11	50	34	10
11	15.5	14.3	12	50	43	10
12	16.8	15.5	13	50	50	10
13	18	16.4	14	50	52	10
14	19.3	17.9	16	50	57	10

## RS2310M/11

Socket Set on Rail  
Juego de Vasos en Regleta



RS2310M/11	11 Pieces set/Rail 200mm	(g)
4, 5, 6, 7, 8, 9, 10, 11, 12, 13, 14		437

## 2325

TORX® Deep Sockets  
Vasos TORX® Largos

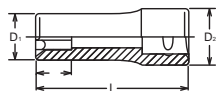

2325 (E)	D <sub>1</sub> (mm)	D <sub>2</sub> (mm)	(mm)	L (mm)	(g)	(pcs.)
E 4	5.4	12	4.6	50	17	10
E 5	6.8	12	5.2	50	20	10
E 6	8	12	5.4	50	20	10
E 7	8.3	12	6.6	50	22	10
E 8	9.8	12	7	50	25	10
E10	11.6	12	8.2	50	29	10

## 2350M

Nut Grip Deep Sockets Nut Grip®  
Vasos Sujeta-tuercas Largos Nut Grip®

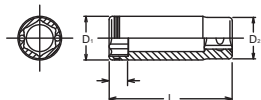

2350M (mm)	D <sub>1</sub> (mm)	D <sub>2</sub> (mm)	(mm)	L (mm)	(g)	(pcs.)
8	12.3	11.2	5	50	30	10
10	14.2	12.9	6	50	35	10
12	17.3	16	7	50	55	10
14	19.9	18	8.5	50	70	10

# 1/4" Hand Sockets

2440M 2445M (mm)	D <sub>1</sub> (mm)	D <sub>2</sub> (mm)	(mm)	L (mm)	(g)	(pcs.)
4	6.7	13	4.8	31.5	17	10
5	8	13	5.3	32	17	10
6	9.2	13	6.1	33	18	10
7	10.5	13	6.5	33	19	10
8	11.7	13	7	34	19	10
9	13	13	7	34	20	10
10	14.2	13	8.3	35	20	10
11	15.5	13	9.5	36	21	10
12	16.7	13	10	37	21	10
13	18	13	10.5	37	26	10
14	19.2	13	10.5	37	28	10

2440A (inch)	D <sub>1</sub> (mm)	D <sub>2</sub> (mm)	(mm)	L (mm)	(g)	(pcs.)
1/4	9.8	13	6.5	33	18	10
5/16	11.7	13	7	34	19	10
3/8	13.7	13	8.3	35	20	10
7/16	15.5	13	9.5	36	21	10
1/2	18	13	10.5	37	26	10
9/16	19.2	13	10.5	37	28	10

2445A (inch)	D <sub>1</sub> (mm)	D <sub>2</sub> (mm)	(mm)	L (mm)	(g)	(pcs.)
3/16	8.8	13	5.3	32	18	10
1/4	9.8	13	6.5	33	18	10
9/32	10.5	13	6.5	33	19	10
5/16	11.7	13	7.5	34	19	10
11/32	13.8	13	7.5	34	20	10
3/8	13.7	13	8.3	35	20	10
7/16	15.5	13	9.5	36	21	10
1/2	18.8	13	10.5	37	26	10
9/16	19.2	13	10.5	37	28	10

RS2445A/9	9 Pieces set/Rail 150mm	(g)
3/16, 1/4, 9/32, 5/16, 11/32, 3/8, 7/16, 1/2, 9/16		220

AS2445A (inch)	D <sub>1</sub> (mm)	D <sub>2</sub> (mm)	(mm)	L (mm)	(g)	(pcs.)
1/4	9.6	12.9	5.7	31.8	18	10
5/16	11.7	12.9	7	34.6	21	10
3/8	13.5	12.9	8.3	35.1	21	10
7/16	15.5	12.9	9.5	39.1	25	10
1/2	17.2	12.9	10.5	40.1	27	10

Aerospace Standard SAE AS954  
Norma Aeroespacial SAE AS954

2440T (E)	D <sub>1</sub> (mm)	D <sub>2</sub> (mm)	(mm)	L (mm)	(g)	(pcs.)
E 6	8	13	5.4	31.9	20	10
E 8	9.8	13	7	33.1	20	10
E10	11.7	13	8.2	33.6	21	10
E12	14.2	13	9.3	35.1	24	10

2441M (mm)	D <sub>1</sub> (mm)	D <sub>2</sub> (mm)	(mm)	L (mm)	(g)	(pcs.)
7	11.3	13	4	33	19	10
8	12.3	13	5	32	19	10
10	14.5	13	6	32.5	21	10
12	16.8	13	7	34	21	10
13	18	13	8	35	21	10
14	20	13	8.5	37	28	10

## 2440M • 2440A 6-point Universal Sockets Vasos Hexagonales con Articulación Universal

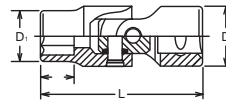

## 2445M • 2445A 12-point Universal Sockets Vasos Bihexagonales con Articulación Universal

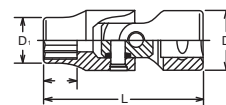

## RS2445A/9 Socket Set on Rail Juego de Vasos en Regleta



## AS2445A 12-point Universal Sockets, AS954 Vasos Bihex con Articulación Universal, AS954

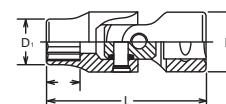

## 2440T TORX® Universal Sockets Vasos TORX® con Articulación Universal

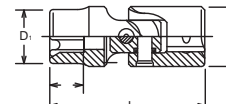

## 2441M Nut Grip® Universal Sockets Vasos Sujeta-Tuercas con Articulación Universal

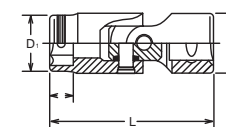

# Hand Sockets 1/4"

HAND MANUALES  
Z-SERIES  
TITANIUM DE TITANIO  
ACCESSORIES ACCESORIOS  
SCREWDRIVERS DESTORNILLADORES  
IMPACT DE IMPACTO  
SLEEVE-DRIVE  
INDUSTRIAL INDUSTRIALES  
AUTOMOTIVE  
CONSTRUCTION CONSTRUCCIÓN  
RENEWAL KITS JUEGOS DE PIEZAS REPLÉSTO

## 2430M Universal Inhex Sockets Vasos Hexagonales con Articulación Universal

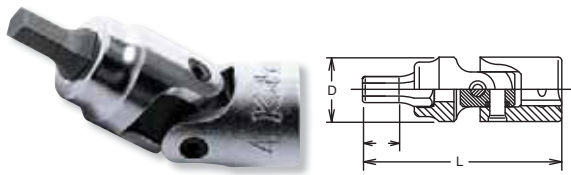

2430M (mm)	D (mm)	(mm)	L (mm)	(g)	(pcs.)
3	13	5.5	40	18	10
4	13	5.5	40	18	10
5	13	6.5	40	20	10
6	13	7.5	40	21	10

## 2430T TORX® Universal Sockets Vasos TORX® con Articulación Universal



2430T (T)	D (mm)	L (mm)	(g)	(pcs.)
T 8	13	42	22	10
T 9	13	42	22	10
T10	13	42	22	10
T15	13	42	22	10
T20	13	42	22	10
T25	13	42	22	10
T27	13	42	22	10
T30	13	42	22	10

## 2000-28 (PH) Phillips Bit Sockets Vasos con Punta Phillips



2000.28 (PH)	D (mm)	L (mm)	(g)	(pcs.)
1	12	28	10	10
2	12	28	11	10
3	12	28	12	10
4	13.1	28	14	10

## 2000-28 (PZ) PZ Bit Sockets Vasos con Punta PZ



2000.28 (PZ)	D (mm)	L (mm)	(g)	(pcs.)
PZ1	12	28	10	10
PZ2	12	28	11	10
PZ3	12	28	12	10

## 2005-25 Slotted Bit Sockets Vasos con Punta Recta para Cabeza Ranurada

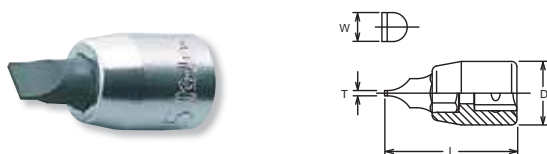

2005.25	T×W (mm)	D (mm)	L (mm)	(g)	(pcs.)
3	0.5× 3	12	25	9	10
4	0.8× 4	12	25	10	10
5	1.0× 5.5	12	25	10	10
6	1.2× 6.5	13.1	25	11	10
8	1.2× 8	13.1	25	12	10
9	1.6× 8	13.1	25	12	10
10	1.6×10	14.3	25	13	10



# 1/4" Hand Sockets

2010M.25 (mm)	D (mm)	L (mm)	(g)	(pcs.)
New 1.5	12	25	9	10
New 2	12	25	9	10
2.5	12	25	9	10
3	12	25	9	10
4	12	25	9	10
5	12	25	10	10
6	12	25	12	10
7	13.1	25	12	10
8	13.1	25	14	10
10	14.3	25	17	10

2010M.100 (mm)	D (mm)	L (mm)	(g)	(pcs.)
New 2	12	100	30	10
2.5	12	100	30	10
3	12	100	30	10
4	12	100	30	10
5	12	100	30	10
6	12	100	35	10
7	13.1	100	35	10
8	13.1	100	38	10
10	14.3	100	45	10

2010A.25 (inch)	D (mm)	L (mm)	(g)	(pcs.)
1/8	12	25	9	10
5/32	12	25	9	10
3/16	12	25	10	10
7/32	12	25	11	10
1/4	12	25	12	10
9/32	13.1	25	12	10
5/16	13.1	25	14	10
3/8	14.3	25	17	10

RS2010M/7-L25	7 Pieces set/Rail 150mm	(g)
3, 4, 5, 6, 7, 8, 10		115

RS2010A/8-L25	8 Pieces set/Rail 150mm	(g)
1/8, 5/32, 3/16, 7/32, 1/4, 9/32, 5/16, 3/8		130

2011M.50 (mm)	D (mm)	L (mm)	(g)	(pcs.)
3	12	50	16	10
4	12	50	17	10
5	12	50	18	10
6	12	50	18	10

⚠ Ball point bit sockets have less strength due to the special design. Make sure to use them correctly.



## 2010M-25 · -100 2010A-25

Inhex Bit Sockets  
Vasos con Punta Hexagonal

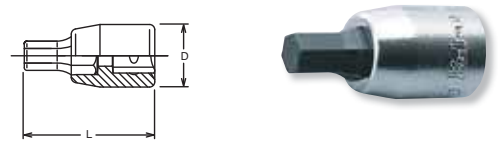

## RS2010M/7-L25 RS2010A/8-L25

Socket Set on Rail  
Juego de Vasos en Regleta



## 2011M-50

Ballpoint Inhex Bit Sockets  
Vasos con Punta de Bola Inhex ⚠

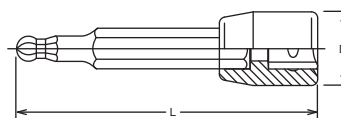

HAND  
MANUALES

Z-SERIES

TITANIUM  
DE TITANIO

ACCESSORIES  
ACCESORIOS

SCREWDRIVERS  
DESTORNILLADORES

IMPACT  
DE IMPACTO

SLEEVE-DRIVE

INDUSTRIAL  
INDUSTRIALES

AUTOMOTIVE

CONSTRUCTION  
CONSTRUCCION

RENEWAL KITS  
JUEGOS DE PIEZAS REPUESTO

# Hand Sockets 1/4"

HAND  
MANUALES

Z-SERIES

TITANIUM  
DE TITANIO

ACCESSORIES  
ACCESORIOS

SCREWDRIVERS  
DESTORNILLADORES

IMPACT  
DE IMPACTO

SLEEVE-DRIVE

INDUSTRIAL  
INDUSTRIALES

AUTOMOTIVE

CONSTRUCTION  
CONSTRUCCION

RENEWAL KITS  
JUEGOS DE PIEZAS REPLÉSTO

## 2020-28 · -50

XZN Bit Sockets  
Vasos con Punta XZN



2020.28 (XZN)	D (mm)	L (mm)	(g)	(pcs.)
M4	12	28	12	10
M5	12	28	12	10
M6	12	28	13	10
M8	13.1	28	14	10

2020.50 (XZN)	D (mm)	L (mm)	(g)	(pcs.)
M4	12	50	20	10
M5	12	50	20	10
M6	12	50	22	10
M8	13.1	50	24	10

## 2025-28 · -80 (T)

TORX® Bit Sockets  
Vasos con Punta TORX®

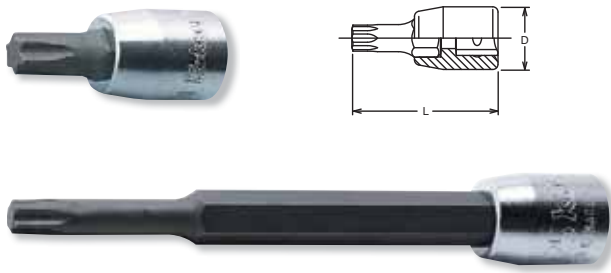

2025.28 (T)	D (mm)	L (mm)	(g)	(pcs.)
<b>New</b> T 8	12	28	10	10
<b>New</b> T 9	12	28	10	10
T10	12	28	10	10
T15	12	28	10	10
T20	12	28	11	10
T25	12	28	11	10
T27	12	28	12	10
T30	12	28	12	10
T40	12	28	13	10

2025.80 (T)	D (mm)	L (mm)	(g)	(pcs.)
T10	12	80	40	10
T15	12	80	40	10
T20	12	80	42	10
T25	12	80	42	10
T27	12	80	45	10
T30	12	80	45	10
T40	12	80	50	10

TORX®  
(T)

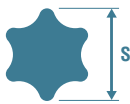

T	T8	T9	T10	T15	T20	T25	T27	T30	T40	T45	T50	T55	T60	T70	T80	T90	T100
S (ref. mm)	2.30	2.48	2.72	3.26	3.84	4.40	4.96	5.49	6.60	7.77	8.79	11.17	13.20	15.49	17.51	19.88	22.09

## RS2025/7-L28

Socket Set on Rail  
Juego de Vasos en Regleta



RS2025/7-L28	7 Pieces set/Rail 150mm	(g)
T10, T15, T20, T25, T27, T30, T40		119

## 2025-28 (TH)

Tamper-Resistant TORX® Bit Sockets  
Vasos con Punta TORX® Indeformable



2025.28 (TH)	D (mm)	L (mm)	(g)	(pcs.)
T10H	12	28	10	10
T15H	12	28	10	10
T20H	12	28	11	10
T25H	12	28	11	10
T27H	12	28	12	10
T30H	12	28	12	10
T40H	12	28	13	10

## RS2025/7-HOLE

Socket Set on Rail  
Juego de Vasos en Regleta



RS2025/7-HOLE	7 Pieces set/Rail 150mm	(g)
T10H, T15H, T20H, T25H, T27H, T30H, T40H		119

Tamper Resistant TORX® Bit Sockets have less strength due to special design. Make sure to use it correctly.

Los Vasos con Punta Indeformable TORX® tienen menos resistencia debido al diseño especial. Asegurarse de su correcta utilización.



# 1/4" Hand Sockets

2025.28 (IP)	D (mm)	L (mm)	(g)	(pcs.)
8IP	12	28	10	10
9IP	12	28	10	10
10IP	12	28	10	10
15IP	12	28	10	10
20IP	12	28	11	10
25IP	12	28	11	10
27IP	12	28	12	10
30IP	12	28	12	10
40IP	12	28	13	10

## 2025-28 (IP)



TORX PLUS® Bit Sockets  
Vasos con Punta TORX PLUS®

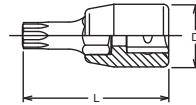

### TORXplus® (IP)



IP	8IP	9IP	10IP	15IP	20IP	25IP	27IP	30IP	40IP	45IP	50IP	55IP	60IP	70IP
S (ref. mm)	2.29	2.48	2.72	3.25	3.84	4.39	4.95	5.49	6.60	7.77	8.79	11.16	13.20	15.49

RS2025/7-IP	7 Pieces set/Rail 150mm	(g)
10IP, 15IP, 20IP, 25IP, 27IP, 30IP, 40IP		119

## RS2025/7-IP



Socket Set on Rail  
Juego de Vasos en Regleta



2025.28 (PR)	D (mm)	L (mm)	(g)	(pcs.)
8PR	12	28	10	10
9PR	12	28	10	10
10PR	12	28	10	10
15PR	12	28	10	10
20PR	12	28	11	10
25PR	12	28	11	10
27PR	12	28	12	10
30PR	12	28	12	10
40PR	12	28	13	10

## 2025-28 (PR)



Penta-Lobe Bit Sockets, with hole  
Vasos con Punta de Cinco Lóbulos, con agujero

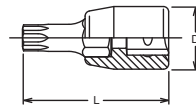

### Penta-Lobe (PR)



PR	8PR	9PR	10PR	15PR	20PR	25PR	27PR	30PR	40PR	45PR	50PR	55PR
S (ref. mm)	2.19	2.36	2.58	3.10	3.64	4.12	4.71	5.23	6.30	7.38	8.35	10.63

RS2025/7-PR	7 Pieces set/Rail 150mm	(g)
10PR, 15PR, 20PR, 25PR, 27PR, 30PR, 40PR		119

## RS2025/7-PR



Socket Set on Rail  
Juego de Vasos en Regleta



HAND MANUALES  
Z-SERIES  
TITANIUM DE TITANIO  
ACCESSORIES ACCESORIOS  
SCREWDRIVERS DESTORNILLADORES  
IMPACT DE IMPACTO  
SLEEVE-DRIVE INDUSTRIAL INDUSTRIALES  
AUTOMOTIVE  
CONSTRUCTION CONSTRUCCION  
RENEWAL KITS JUEGOS DE PIEZAS REPUESTO



# Hand Sockets **1/4"**

HAND  
MANUALES

Z-SERIES

TITANIUM  
DE TITANIO

ACCESSORIES  
ACCESORIOS

SCREWDRIVERS  
DESTORNILLADORES

IMPACT  
DE IMPACTO

SLEEVE-DRIVE

INDUSTRIAL  
INDUSTRIALES

AUTOMOTIVE

CONSTRUCTION  
CONSTRUCCIÓN

RENEWAL KITS  
JUEGOS DE PIEZAS REPLUSTO

## 2753PS Reversible Ratchet Short Llave de Carraca Reversible Corta

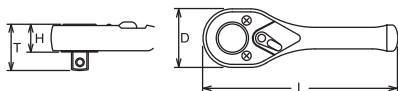

\* Renewal Kits → 2753RK → P276

	D (mm)	T (mm)	H (mm)	L (mm)	(g)	(pcs.)
2753PS	22	18.7	11.4	75	55	5

## 2753N Reversible Ratchet Llave de Carraca Reversible



\* Renewal Kits → 2753RK → P276

## 2753P Reversible Ratchet Llave de Carraca Reversible



\* Renewal Kits → 2753RK → P276

## 2753J Reversible Ratchet Llave de Carraca Reversible

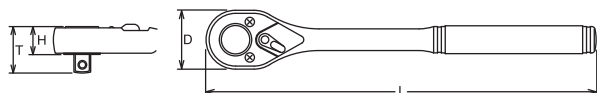

\* Renewal Kits → 2753RK → P276

	D (mm)	T (mm)	H (mm)	L (mm)	(g)	(pcs.)
2753N	22	18.7	11.4	115	90	10
2753P	22	18.7	11.4	115	87	10
2753J	22	18.7	11.4	115	77	5

## 2753P-160 Reversible Ratchet Long Llave de Carraca Reversible Larga

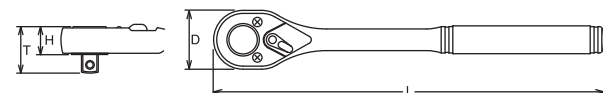

\* Renewal Kits → 2753RK → P276

	D (mm)	T (mm)	H (mm)	L (mm)	(g)	(pcs.)
2753P-160	22	18.7	11.4	160	107	5

# 1/4" Hand Sockets



\* Renewal Kits → 2753BRK → P276



\* Renewal Kits → 2753BRK → P276



\* Renewal Kits → 2753BRK → P276

	D (mm)	T (mm)	H (mm)	L (mm)	(g)	(pcs.)
2753NB	22	18.7	11.4	115	90	10
2753PB	22	18.7	11.4	115	87	10
2753JB	22	18.7	11.4	115	77	5

⚠ Reversible Ratchet with quick release button has less strength compared with normal ratchet due to the technical design. Make sure to use the ratchet correctly.



\* Renewal Kits → 2752RK → P276

	D (mm)	T (mm)	H (mm)	L (mm)	(g)	(pcs.)
2752N	26.5	19.8	12.5	125	95	10



\* Renewal Kits → 2753RK → P276



\* Renewal Kits → 2753RK → P276

	D (mm)	T (mm)	H (mm)	L (mm)	(g)	(pcs.)
2774PS	22	18.7	11.4	116	110	5
2774JS	22	18.7	11.4	116	113	5

**2753NB** Reversible Ratchet with quick release button  
Llave de Carraca Reversible con botón de extracción rápida ⚠



**2753PB** Reversible Ratchet with quick release button  
Llave de Carraca Reversible con botón de extracción rápida ⚠



**2753JB** Reversible Ratchet with quick release button  
Llave de Carraca Reversible con botón de extracción rápida ⚠

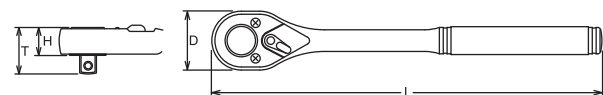

**2752N** Reversible Ratchet  
Llave de Carraca Reversible

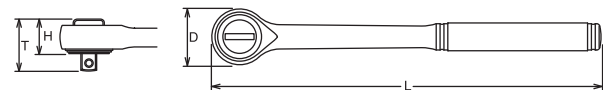

**2774PS** Flexible Ratchet, Reversible  
Llave de Carraca Flexible, Reversible



**2774JS** Flexible Ratchet, Reversible  
Llave de Carraca Flexible, Reversible



HAND  
MANUALES

Z-SERIES

TITANIUM  
DE TITANIO

ACCESSORIES  
ACCESORIOS

SCREWDRIVERS  
DESTORNILLADORES

IMPACT  
DE IMPACTO

SLEEVE-DRIVE  
INDUSTRIAL

INDUSTRIAL  
INDUSTRIALES

AUTOMOTIVE

CONSTRUCTION  
CONSTRUCCION

RENEWAL KITS  
JUEGOS DE PIEZAS REPUESTO

# Hand Sockets 1/4"

HAND MANUALES  
Z-SERIES  
TITANIUM DE TITANIO  
ACCESSORIES ACCESORIOS  
SCREWDRIVERS DESTORNILLADORES  
IMPACT DE IMPACTO  
SLEEVE-DRIVE  
INDUSTRIAL INDUSTRIALES  
AUTOMOTIVE  
CONSTRUCTION CONSTRUCCIÓN  
RENEWAL KITS JUEGOS DE PIEZAS REPLUSTO

**2774N** Flexible Ratchet, Reversible  
Llave de Carraca Flexible, Reversible



\* Renewal Kits → 2753RK → P276

**2774P** Flexible Ratchet, Reversible  
Llave de Carraca Flexible, Reversible



\* Renewal Kits → 2753RK → P276

**2774J** Flexible Ratchet, Reversible  
Llave de Carraca Flexible, Reversible



\* Renewal Kits → 2753RK → P276

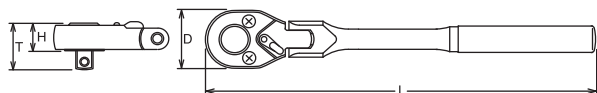

	D (mm)	T (mm)	H (mm)	L (mm)	(g)	(pcs.)
2774N	22	18.7	11.4	161	130	2
2774P	22	18.7	11.4	161	126	2
2774J	22	18.7	11.4	161	130	2

**2755** Ratchet Adaptor  
Adaptador de carraca

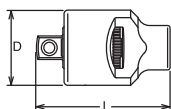

\* Renewal Kits → 2755RK → P278

	D (mm)	L (mm)	(g)	(pcs.)
2755	26	40	80	10

**2756** Quick Spinner  
Disco de giro Rápido

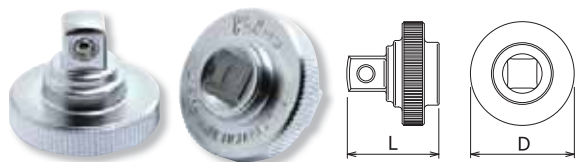

	D (mm)	L (mm)	(g)	(pcs.)
2756	22	20	19	10

**2762** Flexible Extension Bar  
Alargadera Flexible

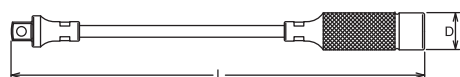

	D (mm)	L (mm)	(g)	(pcs.)
2762	13	300	90	2

2760	D (mm)	L (mm)	(g)	(pcs.)
28	12.3	28	14	10
50	12.3	50	23	10
<b>New</b> 75	12.3	75	35	10
100	12.3	100	44	10
150	12.3	150	63	10
200	12.3	200	83	10
250	12.3	250	103	10
300	12.3	300	122	2
350	12.3	350	145	2
400	12.3	400	160	2
600	12.3	600	240	2

<b>PK2760/6</b>	6 Pieces Set/△=430g
PLASTIC TRAY	
Extension Bars	
2760 Extension Bars 28, 50, 100, 150, 200, 250	



2763	D (mm)	L (mm)	(g)	(pcs.)
28	12.3	28	14	10
50	12.3	50	23	10
75	12.3	75	33	10
100	12.3	100	43	10
150	12.3	150	62	10
200	12.3	200	80	10
250	12.3	250	100	10

<b>PK2763/6</b>	6 Pieces Set/△=420g
PLASTIC TRAY	
Extension Bars	
2763 Wobble-Fix Extension Bar 28, 50, 100, 150, 200, 250	

**Wobble-Fix Extension Bar**  
Two way usage : One for as a flexible extension bar to provide at 15° angle operation, the other for use as a normal extension bar. This usage is Patent.

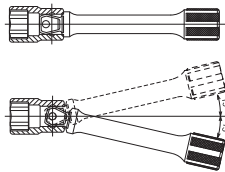

**Alargadera Articulada-Fija**  
Dos formas de utilización : Una como alargadera flexible para poder trabajar con un ángulo de 15° y otra para utilizarse como alargadera normal. Esta aplicación está patentada.

**⚠** The Wobble-Fix Extension Bar has less strength than normal extension bar due to it's specific design with a reduced square drive. Make sure to use it correctly.

\* Renewal Kits → **2768RK** → **P278**

\* Renewal Kits → **2768RK** → **P278**

\* Renewal Kits → **2768RK** → **P278**

	D (mm)	L (mm)	(g)	(pcs.)
2768N	14	130	86	10
2768P	14	130	70	10
2768J	14	130	73	5

## 2760-28 · -50 · -75 · -100 · -150 · -200 · -250 · -300 · -350 · -400 · -600

Extension Bars  
Alargaderas

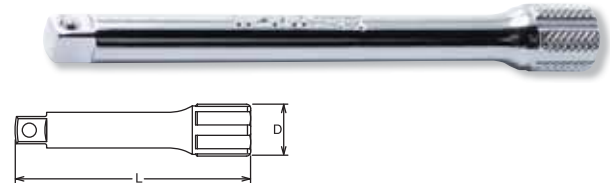

### PK2760/6 Set Juego



## 2763-28 · -50 · -75 · -100 · -150 · -200 · -250

Wobble-Fix Extension Bars  
Alargaderas Articuladas-Fijas ⚠

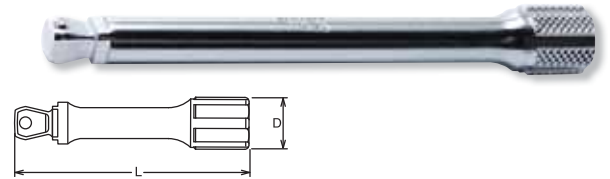

### PK2763/6 Set Juego



### 2768N Hinge Handle Mango Articulado



### 2768P Hinge Handle Mango Articulado



### 2768J Hinge Handle Mango Articulado

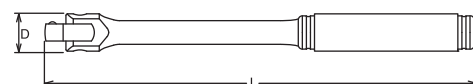



# Hand Sockets 1/4"

HAND MANUALES  
Z-SERIES  
TITANIUM DE TITANIO  
ACCESSORIES ACCESORIOS  
SCREWDRIVERS DESTORNILLADORES  
IMPACT DE IMPACTO  
SLEEVE-DRIVE  
INDUSTRIAL INDUSTRIALES  
AUTOMOTIVE  
CONSTRUCTION CONSTRUCCION  
RENEWAL KITS JUEGOS DE PIEZAS REPLUESTO

## 2769N-150 • -220 Spin Type Handle Mango Tipo Destornillador ⚠

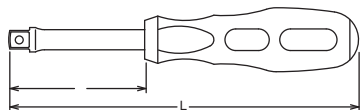

2769N	(mm)	L (mm)	(g)	(pcs.)
150	50	150	68	2
220	120	220	100	2

⚠ Plastic or rubber handles are not intended to act as insulation.  
Los mangos de plástico o de goma no están previstos para aislamiento.

## 2769NWF-150 • -220 Spin Type Handle(Wobble-Fix) Mango Tipo Destornillador Articulado-Fijos ⚠

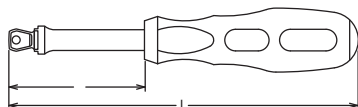

2769NWF	(mm)	L (mm)	(g)	(pcs.)
150	50	150	68	2
220	120	220	100	2

### Wobble-Fix Extension Bar

Two way usage : One for as a flexible extension bar to provide at 15° angle operation, the other for use as a normal extension bar. This usage is Patent.

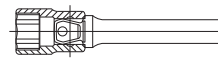

### Alargadera Articulada-Fija

Dos formas de utilización : Una como alargadera flexible para poder trabajar con un ángulo de 15° y otra para utilizarse como alargadera normal. Esta aplicación está patentada.

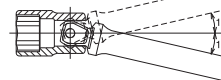

## 2769F Spin Type Handle Mango Tipo Destornillador

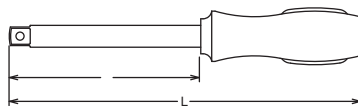

2769F	(mm)	L (mm)	(g)	(pcs.)
2769F	78	150	90	5

## 2769H Folding Socket Driver Llave de Vaso Plegable

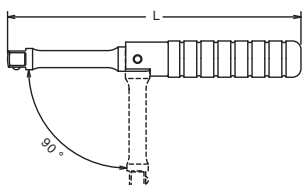
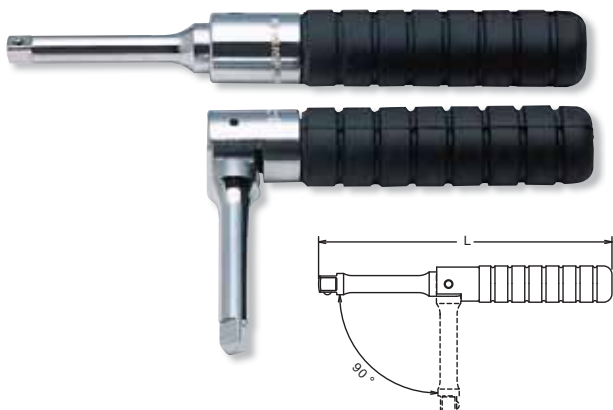

2769H	L (mm)	(g)	(pcs.)
2769H	160	180	10

# 1/4" Hand Sockets

	L (mm)	(g)	(pcs.)
2770	33	20	10
2771	31	20	10

**2770** Universal Joint  
Articulación Universal

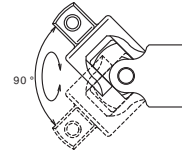
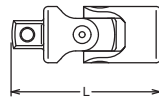

**2771** Universal Joint  
Articulación Universal

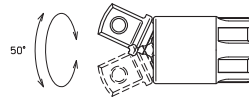
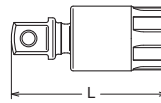

	L (mm)	(g)	(pce.)
2780	350	250	1

**2780** Speed Handle  
Manivela Rápida

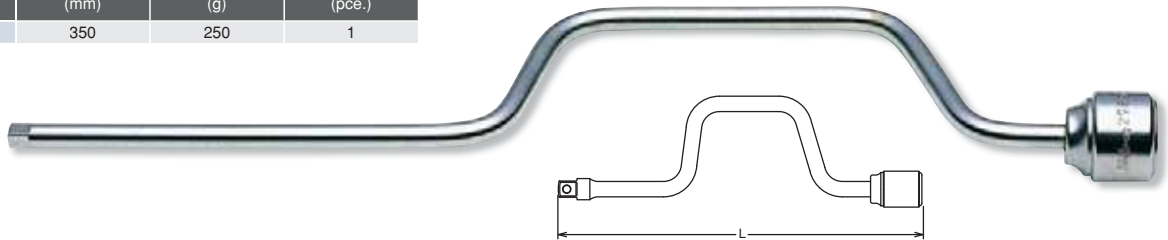

**2785** T-Handle  
Mango Corredizo

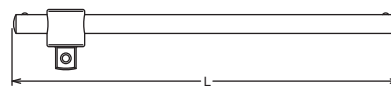

	L (mm)	(g)	(pcs.)
2785	115	36	10

	(sq.)	(sq.)	L (mm)	(g)	(pcs.)
2233A	1/4"	3/8"	22	16	10

**2233A** Adaptor  
Adaptador

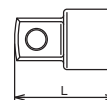

HAND  
MANUALES

Z-SERIES

TITANIUM  
DE TITANIO

ACCESSORIES  
ACCESORIOS

SCREWDRIVERS  
DESTORNILLADORES

IMPACT  
DE IMPACTO

SLEEVE-DRIVE

INDUSTRIAL  
INDUSTRIALES

AUTOMOTIVE

CONSTRUCTION  
CONSTRUCCION

RENEWAL KITS  
JUEGOS DE PIEZAS REPIESTO

# Hand Sockets 1/4"

HAND MANUALES  
Z-SERIES  
TITANIUM DE TITANIO  
ACCESSORIES ACCESORIOS  
SCREWDRIVERS DESTORNILLADORES  
IMPACT DE IMPACTO  
SLEEVE-DRIVE  
INDUSTRIAL INDUSTRIALES  
AUTOMOTIVE  
CONSTRUCTION CONSTRUCCION  
RENEWAL KITS JUEGOS DE PIEZAS REPLÉSTO

## 2201AM Socket Set Juego de Vasos



2201AM		25 Pieces Set/△=870g
METAL CASE:W240xH100xT32mm		
Sockets	Accessories	
<p> <b>2400M</b> 6-pt. Sockets 4, 5, 5.5, 6, 7, 8, 9, 10, 11, 12, 13</p> <p> <b>2400A</b> 6-pt. Sockets 3/16, 7/32, 1/4, 9/32, 5/16, 11/32, 3/8, 7/16, 1/2</p>	<p> <b>2753N</b></p> <p> <b>2760-100</b></p> <p> <b>2769N-150</b></p> <p> <b>2770</b></p> <p> <b>2785</b></p>	

## 2203M • 2203A Socket Set Juego de Vasos



2203M		12 Pieces Set/△=550g
METAL CASE:W160xH100xT28mm		
Sockets	Accessories	
<p> <b>2400M</b> 6-pt. Sockets 4, 4.5, 5, 5.5, 6, 7, 8, 9, 10, 11, 13</p>	<p> <b>2769H</b></p>	
2203A		10 Pieces Set/△=550g
METAL CASE:W160xH100xT28mm		
Sockets	Accessories	
<p> <b>2400A</b> 6-pt. Sockets 3/16, 7/32, 1/4, 9/32, 5/16, 11/32, 3/8, 7/16, 1/2</p>	<p> <b>2769H</b></p>	

## 2250M • 2250A Socket Set Juego de Vasos



2250M		16 Pieces Set/△=700g
METAL CASE:W160xH100xT28mm		
Sockets	Accessories	
<p> <b>2400M</b> 6-pt. Sockets 5, 6, 7, 8, 9, 10, 11, 12</p> <p> <b>2415M</b> Double Square Sockets 8, 10</p>	<p> <b>2753N</b></p> <p> <b>2760-50</b></p> <p> <b>2760-150</b></p> <p> <b>2768N</b></p> <p> <b>2770</b></p> <p> <b>2785</b></p>	

2250A		16 Pieces Set/△=700g
METAL CASE:W160xH100xT28mm		
Sockets	Accessories	
<p> <b>2400A</b> 6-pt. Sockets 7/32, 1/4, 9/32, 5/16, 11/32, 3/8, 7/16</p> <p> <b>2415A</b> Double Square Sockets 1/4, 5/16, 3/8</p>	<p> <b>2753N</b></p> <p> <b>2760-50</b></p> <p> <b>2760-150</b></p> <p> <b>2768N</b></p> <p> <b>2770</b></p> <p> <b>2785</b></p>	

## 2254M Bit Set Juego de Puntas



2254M		12 Pieces Set/△=450g
METAL CASE:W160xH100xT28mm		
Bits	Accessories	
<p> <b>101P</b> Phillips Bits 1, 2, 3</p> <p> <b>101S</b> Slotted Bits 1x7, 1.2x7</p> <p> <b>101H</b> Hex Bits 3, 4, 5</p>	<p> <b>102NA-1/4x5/16</b></p> <p> <b>2769F</b></p> <p> <b>101A</b></p> <p> <b>2137</b></p>	

# 1/4" Hand Sockets

HAND MANUALES  
Z-SERIES  
TITANIUM DE TITANIO  
ACCESSORIES ACCESORIOS  
SCREWDRIVERS DESTORNILLADORES  
IMPACT DE IMPACTO  
SLEEVE-DRIVE  
INDUSTRIAL INDUSTRIALES  
AUTOMOTIVE  
CONSTRUCTION CONSTRUCCION  
RENEWAL KITS JUEGOS DE PIEZAS REPUESTO

<b>2257M</b> 31 Pieces Set/Δ=930g	
METAL CASE:W240xH100xT32mm	
Sockets	Accessories
<b>2400M</b> 6-pt. Sockets 4, 4.5, 5, 5.5, 6, 7, 8, 9, 10, 11, 12	<b>2753N</b> <b>2760-100</b> <b>2769N-150</b> <b>2770</b> <b>2785</b>
<b>2000.28</b> Bit Sockets 1, 2, 3, 4	
<b>2005.25</b> Bit Sockets 4, 5, 6, 8, 9	
<b>2010M.25</b> Bit Sockets 3, 4, 5, 6, 8, 10	

**2257M** Socket Set  
Juego de Vasos



<b>2260M</b> 28 Pieces Set/Δ=2,370g	
METAL CASE: W370xH150xT50mm	
Sockets	Accessories
<b>2400M</b> 6-pt. Sockets 4, 5, 5.5, 6, 7, 8, 10, 12	<b>2753N</b> <b>2760-50</b> <b>2760-100</b> <b>2769N-150</b>
<b>3400M</b> 6-pt. Sockets 8, 10, 11, 12, 13, 14, 15, 17, 18, 19, 21	<b>3749N</b> <b>3760-75</b> <b>3760-125</b> <b>3785</b> <b>3322A</b>

**2260M** Socket Set  
Juego de Vasos



<b>2261M</b> 17 Pieces Set/Δ=690g	
METAL CASE:W192xH122xT30mm	
Sockets	Accessories
<b>2400M</b> 6-pt. Sockets 4, 4.5, 5, 5.5, 6, 7, 8, 9, 10, 11, 12	<b>2753N</b> <b>2760-50</b> <b>2760-150</b> <b>2768N</b> <b>2770</b> <b>2785</b>

**2261M** Socket Set  
Juego de Vasos



<b>2262M</b> 13 Pieces Set/Δ=470g	
METAL CASE:W192xH122xT30mm	
Sockets	Accessories
<b>2400M</b> 6-pt. Sockets 4, 4.5, 5, 5.5, 6, 7, 8, 9, 10, 11, 12	<b>2760-50</b> <b>2768N</b>

**2262M** Socket Set  
Juego de Vasos



<b>2274M</b> 7 Pieces Set/Δ=245g	
PLASTIC BAG	
Sockets	
<b>2300M</b> 6-pt. Deep Sockets 6, 7, 8, 9, 10, 11, 12	

**2274M · 2274A** Socket Set  
Juego de Vasos



<b>2274A</b> 7 Pieces Set/Δ=245g	
PLASTIC BAG	
Sockets	
<b>2300A</b> 6-pt. Deep Sockets 1/4, 9/32, 5/16, 11/32, 3/8, 7/16, 1/2	



# Hand Sockets 1/4"

HAND MANUALES  
Z-SERIES  
TITANIUM DE TITANIO  
ACCESSORIES ACCESORIOS  
SCREWDRIVERS DESTORNILLADORES  
IMPACT DE IMPACTO  
SLEEVE-DRIVE  
INDUSTRIAL INDUSTRIALES  
AUTOMOTIVE  
CONSTRUCTION CONSTRUCCION  
RENEWAL KITS JUEGOS DE PIEZAS REPLÉSTO

## 2275 Sockets Set Juego de Vasos



2275		19 Pieces Set/⚖️=880g	
METAL CASE:W192xH122xT30mm			
Sockets		Accessories	
⚙️	<b>2400M</b> 6-pt. Sockets 5.5, 6, 7, 8, 10, 12, 13		<b>2753N</b>
+	<b>2000.28</b> Bit Sockets 1, 2, 3		<b>2763-50</b>
⊖	<b>2005.25</b> Bit Sockets 6, 8		<b>2769N-150</b>
⚙️	<b>2010M.25</b> Bit Sockets 3, 4, 5, 6		

## 2276 Sockets Set with Bits and Accessories Juego de vasos con Puntas y Accesorios



2276		19 Pieces Set/⚖️=640g	
METAL CASE:W192xH122xT30mm			
Bits		Accessories	
+	<b>108P</b> Phillips Bits 1, 2, 3		<b>2753PS</b>
⊖	<b>108S</b> Slotted Bits 4, 5, 6		<b>2769N-150</b>
⚙️	<b>108H</b> Hex Bits 3, 4, 5, 6		<b>2137</b>
⚙️	<b>108T TORX®</b> Bits T10, T15, T20, T25, T27, T30		

## 2277 Sockets Set Juego de Vasos







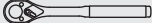

2277		21 Pieces Set/⚖️=1,240g	
METAL CASE:W310xH86xT50mm			
Sockets		Accessories	
⚙️	<b>2400M</b> 6-pt. Sockets 5.5, 6, 7, 8, 9, 10, 11, 12, 13		<b>2753N</b>
⚙️	<b>2300M</b> 6-pt. Deep Sockets 5.5, 6, 7, 8, 9, 10, 11, 12, 13		<b>2763-75</b>
			<b>2769N-150</b>

## 2277A-12P Sockets Set Juego de Vasos

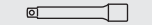







2277A-12P		21 Pieces Set/⚖️=1,240g	
METAL CASE:W310xH86xT50mm			
Sockets		Accessories	
⚙️	<b>2405A</b> 12-pt. Sockets 7/32, 1/4, 9/32, 5/16, 11/32, 3/8, 7/16, 1/2, 9/16		<b>2753N</b>
⚙️	<b>2305A</b> 12-pt. Deep Sockets 7/32, 1/4, 9/32, 5/16, 11/32, 3/8, 7/16, 1/2, 9/16		<b>2763-75</b>
			<b>2769N-150</b>

P2201AM		25 Pieces Set/Δ=800g	
PLASTIC CASE:W245xH120xT45mm			
Sockets		Accessories	
	<b>2400M</b> 6-pt. Sockets 4, 5, 5.5, 6, 7, 8, 9, 10, 11, 12, 13		<b>2753N</b>
	<b>2400A</b> 6-pt. Sockets 3/16, 7/32, 1/4, 9/32, 5/16, 11/32, 3/8, 7/16, 1/2		<b>2760-100</b>
			<b>2769N-150</b>
			<b>2770</b>
			<b>2785</b>



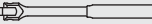







**P2201AM** Sockets Set  
Juego de Vasos



P2251M		18 Pieces Set/Δ=770g	
PLASTIC CASE:W245xH120xT45mm			
Sockets		Accessories	
	<b>2400M</b> 6-pt. Sockets 4, 4.5, 5, 5.5, 6, 7, 8, 9, 10, 11, 12, 13		<b>2753N</b>
			<b>2760-50</b>
			<b>2760-150</b>
			<b>2768N</b>
			<b>2770</b>
			<b>2785</b>





**P2251M** Sockets Set  
Juego de Vasos



P2258M		31 Pieces Set/Δ=860g	
PLASTIC CASE:W245xH120xT45mm			
Sockets		Accessories	
	<b>2400M</b> 6-pt. Sockets 4, 5, 5.5, 6, 7, 8, 9, 10, 11, 12, 13		<b>2753N</b>
	<b>2000.28</b> Bit Sockets 1, 2, 3		<b>2760-100</b>
	<b>2005.25</b> Bit Sockets 4, 6		<b>2769N-150</b>
	<b>2010M.25</b> Bit Sockets 3, 4, 5, 6, 8		<b>2770</b>
	<b>2025.28</b> Bit Sockets T10, T15, T20, T25, T30		<b>2785</b>

**P2258M** Sockets Set  
Juego de Vasos

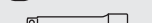
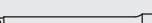

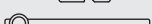
P2281A-12P		18 Pieces Set/Δ=770g	
PLASTIC CASE:W245xH120xT45mm			
Sockets		Accessories	
	<b>2405A</b> 12-pt. Sockets 1/8, 5/32, 3/16, 7/32, 1/4, 9/32, 5/16, 11/32, 3/8, 7/16, 1/2, 9/16		<b>2753N</b>
			<b>2760-50</b>
			<b>2760-150</b>
			<b>2768N</b>
			<b>2770</b>
			<b>2785</b>

**P2281A-12P** Sockets Set  
Juego de Vasos



ABS Case - PE foam insert  
Caja ABS - espuma polietileno

# Hand Sockets **3/8"**

HAND MANUALES  
Z-SERIES  
TITANIUM DE TITANIO  
ACCESSORIES ACCESORIOS  
SCREWDRIVERS DESTORNILLADORES  
IMPACT DE IMPACTO  
SLEEVE-DRIVE  
INDUSTRIAL INDUSTRIALES  
AUTOMOTIVE  
CONSTRUCTION CONSTRUCCION  
RENEWAL KITS JUEGOS DE PIEZAS REPLÉSTO

## 3400M • 3400A

6-point Sockets  
Vasos Hexagonales

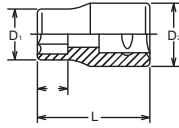

## 3405M • 3405A

12-point Sockets  
Vasos Bihexagonales

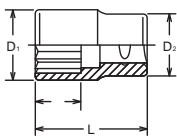

## FLAT DRIVE®

Flat drive is designed to guarantee a flat surface contact between the socket and the bolt/nut. The Flat contact reduces wear and allows to transmit a higher torque value. The Flat Drive System is also used for the square drive end as well as the hexagonal or bi-hexagonal openings of the socket.

El diseño de contacto plano garantiza una superficie de contacto plana entre el vaso y el perno/tuerca. El contacto plano reduce el desgaste y permite transmitir más par. El Sistema de Contacto Plano se utiliza tanto para el extremo del cuadrado conductor como para la boca del vaso Hex o Bihex.

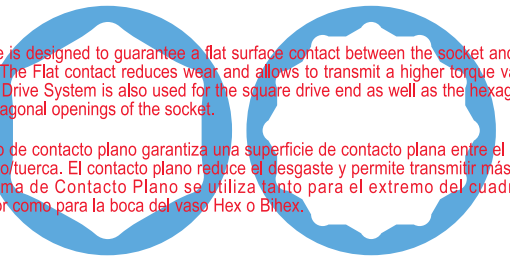

## RS3400M/8 RS3405M/8

Socket Set on Rail  
Juego de Vasos en Regleta



## RS3400M/12 RS3405M/12

Socket Set on Rail  
Juego de Vasos en Regleta



## RS3400A/9 RS3405A/9

Socket Set on Rail  
Juego de Vasos en Regleta



	3400M 3405M (mm)	D <sub>1</sub> (mm)	D <sub>2</sub> (mm)	(mm)	L (mm)	(g)	(pcs.)
New	5	8.3	17.3	5	26	20	10
New	5.5	8.9	17.3	5.5	26	20	10
	6	9.9	17.3	6	26	20	10
	7	10.8	17.3	6.5	26	20	10
	8	12	17.3	7	26	22	10
	9	13.3	17.3	7.5	26	23	10
	10	14.5	17.3	8	26	24	10
	11	15.8	17.3	8.5	26	25	10
	12	16.8	17.3	9	26	25	10
	13	18	17	9.5	26	24	10
	14	19.5	18.5	11	27	31	10
	15	20.8	19.5	11.5	28	39	10
	16	22	20	12	28	42	10
	17	23.3	21.5	12.5	29	51	10
	18	24.5	22.5	13	30	51	10
	19	25.8	23.5	13.5	30	63	10
	20	27	24.5	14	31	75	10
	21	28	26	14.5	32	77	10
	22	29.5	26.5	15	32	82	10
	23	30.8	27.5	15.5	33	95	10
	24	32	28.5	16	34	102	10

	3400A 3405A (inch)	D <sub>1</sub> (mm)	D <sub>2</sub> (mm)	(mm)	L (mm)	(g)	(pcs.)
	1/4	10.3	17.3	6	26	20	10
	5/16	12	17.3	7	26	22	10
	11/32	13.3	17.3	7.5	26	23	10
	3/8	13.9	17.3	8	26	23	10
	7/16	15.8	17.3	8.5	26	25	10
	1/2	18	17	9.5	26	24	10
	9/16	19.5	18.5	11	27	31	10
	19/32	20.8	19.5	11.5	28	39	10
	5/8	22	20	12	28	42	10
	11/16	24.5	22.5	13	30	51	10
	3/4	25.8	23.5	13.5	30	63	10
	25/32	27	24.5	14	31	75	10
	13/16	28	26	14.5	32	77	10
	7/8	29.5	26.5	15	32	82	10
	15/16	32	28.5	16	34	102	10

RS3400M/8	8 Pieces Set/Rail 200mm	(g)
8, 10, 11, 12, 13, 14, 17, 19		300

RS3405M/8	8 Pieces Set/Rail 200mm	(g)
8, 10, 11, 12, 13, 14, 17, 19		300

RS3400M/12	12 Pieces Set/Rail 300mm	(g)
8, 9, 10, 11, 12, 13, 14, 15, 16, 17, 18, 19		465

RS3405M/12	12 Pieces Set/Rail 300mm	(g)
8, 9, 10, 11, 12, 13, 14, 15, 16, 17, 18, 19		465

RS3400A/9	9 Pieces Set/Rail 200mm	(g)
1/4, 5/16, 3/8, 7/16, 1/2, 9/16, 5/8, 11/16, 3/4		333

RS3405A/9	9 Pieces Set/Rail 200mm	(g)
1/4, 5/16, 3/8, 7/16, 1/2, 9/16, 5/8, 11/16, 3/4		333

3410M (mm)	D <sub>1</sub> (mm)	D <sub>2</sub> (mm)	(mm)	L (mm)	(g)	(pcs.)
<b>5.5</b>	8.9	17.3	5.5	26	20	10
<b>6</b>	9.9	17.3	6	26	20	10
<b>7</b>	10.8	17.3	6.5	26	20	10
<b>8</b>	12	17.3	7	26	22	10
<b>9</b>	13.3	17.3	7.5	26	23	10
<b>10</b>	14.5	17.3	8	26	24	10
<b>11</b>	15.8	17.3	8.5	26	25	10
<b>12</b>	16.8	17.3	9	26	25	10
<b>13</b>	18	17	9.5	26	24	10
<b>14</b>	19.5	18.5	11	27	31	10
<b>15</b>	20.8	19.5	11.5	28	39	10
<b>16</b>	22	20	12	28	42	10
<b>17</b>	23.3	21.5	12.5	29	51	10
<b>18</b>	24.5	22.5	13	30	51	10
<b>19</b>	25.8	23.5	13.5	30	63	10
<b>20</b>	27	24.5	14	31	75	10
<b>21</b>	28	26	14.5	32	77	10
<b>22</b>	29.5	26.5	15	32	82	10
<b>23</b>	30.8	27.5	15.5	33	95	10
<b>24</b>	32	28.5	16	34	102	10

RS3410M/12	12 Pieces Set/Rail 300mm	(g)
8, 9, 10, 11, 12, 13, 14, 15, 16, 17, 18, 19		468

3400W (W)	D <sub>1</sub> (mm)	D <sub>2</sub> (mm)	(mm)	L (mm)	(g)	(pcs.)
<b>1/8</b>	13.3	17.3	7.5	26	22	10
<b>3/16</b>	15.8	17.3	8.5	26	25	10
<b>1/4</b>	18	17	9.5	26	24	10
<b>5/16</b>	20.8	19.5	11.5	28	39	10
<b>3/8</b>	24.5	22.5	13	30	51	10
<b>7/16</b>	28	26	14.5	32	81	10
<b>1/2</b>	30.8	27.5	15.5	33	103	10
<b>9/16</b>	34.5	30.5	17	35	128	10

### BS W



BS · W	BS	3/16BS	1/4BS	5/16BS	3/8BS	7/16BS	1/2BS	9/16BS	5/8BS	11/16BS	3/4BS	7/8BS
	W	1/8W	3/16W	1/4W	5/16W	3/8W	7/16W	1/2W	9/16W	5/8W	11/16W	3/4W
Across Flat	(ref. mm)	8.64	11.30	13.34	15.24	18.03	20.83	23.37	25.65	27.94	30.48	33.35

RS3400W/7	7 Pieces Set/Rail 200mm	(g)
1/8, 3/16, 1/4, 5/16, 3/8, 7/16, 1/2		389

RS3405W/7	7 Pieces Set/Rail 200mm	(g)
1/8, 3/16, 1/4, 5/16, 3/8, 7/16, 1/2		389

3415M (mm)	D <sub>1</sub> (mm)	D <sub>2</sub> (mm)	(mm)	L (mm)	(g)	(pcs.)
<b>6</b>	12.5	17.3	6	26	24	10
<b>8</b>	14.5	17.3	7	26	26	10
<b>10</b>	16.8	17.3	8	26	27	10
<b>12</b>	20.8	19.5	9	27	43	10

3415A (inch)	D <sub>1</sub> (mm)	D <sub>2</sub> (mm)	(mm)	L (mm)	(g)	(pcs.)
<b>1/4</b>	12	17.3	6	26	24	10
<b>5/16</b>	14.5	17.3	7	26	26	10
<b>11/32</b>	15.8	17.3	7.5	26	27	10
<b>3/8</b>	16.8	17.3	8	26	27	10
<b>7/16</b>	19.5	18.5	8.5	27	37	10
<b>1/2</b>	22	20	9.5	27	46	10

## 3410M Surface Drive Sockets Vasos Surface Drive (de Contacto Curvo)

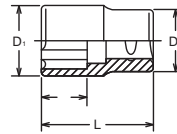

## SURFACE DRIVE

Surface drive sockets are designed to retain contact with flat sides of nut to transmit high torque and reduce nut wear. These sockets are ideal for use on polished nuts, aluminum nuts and nuts with worn out points.

Los vasos de contacto curvo se diseñan para mantener el contacto con las caras planas de la tuerca y transmitir un alto par reduciendo el desgaste de la tuerca. Estos vasos son ideales para utilizarse en tuercas pulidas, tuercas de aluminio y tuercas con puntas gastadas

## RS3410M/12 Socket Set on Rail Juego de Vasos en Regleta



## 3400W 6-point Whitworth Sockets Vasos Hexagonales Whitworth

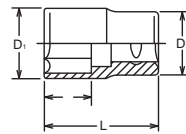

## 3405W 12-point Whitworth Sockets Vasos Bihexagonales Whitworth

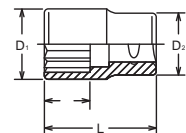

## RS3400W/7 Socket Set on Rail Juego de Vasos en Regleta

## RS3405W/7



## 3415M · 3415A Double Square Sockets Vasos Octagonales

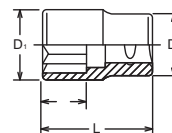



# Hand Sockets **3/8"**

HAND MANUALES  
Z-SERIES  
TITANIUM DE TITANIO  
ACCESSORIES ACCESORIOS  
SCREWDRIVERS DESTORNILLADORES  
IMPACT DE IMPACTO  
SLEEVE-DRIVE  
INDUSTRIAL INDUSTRIALES  
AUTOMOTIVE  
CONSTRUCTION CONSTRUCCIÓN  
RENEWAL KITS JUEGOS DE PIEZAS REPLÉSTO

## 3425 TORX® Sockets Vasos TORX®

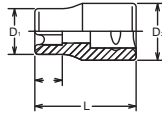

3425 (E)	D <sub>1</sub> (mm)	D <sub>2</sub> (mm)	(mm)	L (mm)	(g)	(pcs.)
E 4	5.6	17.3	4.6	26	18	10
E 5	7	17.3	5.2	26	20	10
E 6	8.3	17.3	5.4	26	21	10
E 7	8.9	17.3	6.6	26	22	10
E 8	9.9	17.3	7	26	23	10
E10	12	17.3	8.2	26	24	10
E11	13.3	17.3	8.7	26	25	10
E12	14.5	17.3	9.3	26	26	10
E14	15.8	17.3	10.6	26	27	10
E16	18	17	11.8	26	27	10

## TORX® (E)

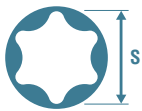

E	E4	E5	E6	E7	E8	E10	E11	E12	E14	E16	E18	E20	E22	E24	E26	E28
S (ref. mm)	3.83	4.72	5.69	6.17	7.47	9.37	10.03	11.12	12.85	14.71	16.64	18.41	20.24	22.10	23.85	25.65

## RS3425/9 Socket Set on Rail Juego de Vasos en Regleta



RS3425/9	9 Pieces Set/Rail 200mm	(g)
<b>E4, E5, E6, E7, E8, E10, E12, E14, E16</b>		239

## 3425(2B) TORX® Sockets Nut Grip® Vasos TORX® Nut Grip®

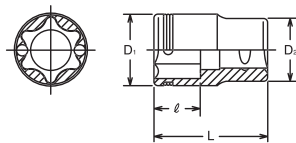

3425 (2B)	D <sub>1</sub> (mm)	D <sub>2</sub> (mm)	(mm)	L (mm)	(g)	(pcs.)
E10	12	17.3	8.2	26	23	10
E12	14.5	17.3	9.3	26	25	10
E14	15.8	17.3	10.6	26	26	10
<b>E16</b>	18.1	17	11.8	26	27	10
<b>E18</b>	19.5	18.5	12	32	41	10
E20	21.9	20	14.4	32	52	10

## RS3425/4(2B) Socket Set on Rail Juego de Vasos en Regleta



RS3425/4(2B)	4 Pieces Set/Rail 150mm	(g)
<b>E10, E12, E14, E20</b>		150

## 3450M Nut Grip Sockets Nut Grip® Vasos Sujeta-tuercas Nut Grip®

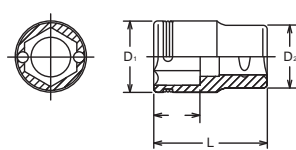

3450M (mm)	D <sub>1</sub> (mm)	D <sub>2</sub> (mm)	(mm)	L (mm)	(g)	(pcs.)
8	12	17.3	5	26	21	10
10	14.5	17.3	6	26	24	10
11	15.8	17.3	6.5	26	26	10
12	16.8	17.3	7	26	26	10
13	18	17	8	26	28	10
14	19.5	18.5	8.5	27	34	10
15	20.8	19.5	9	27	42	10
16	22	20	9	27	50	10
17	23.3	21.5	9.5	28	62	10
18	24.5	22.5	10.5	29	64	10
19	25.8	23.3	11.5	29	66	10
21	28	26	12	29	85	10
22	29.5	27	12.5	29	90	10
24	32	30	14.5	31	102	10

## RS3450M/8 Socket Set on Rail Juego de Vasos en Regleta



RS3450M/8	8 Pieces Set/Rail 200mm	(g)
<b>8, 10, 11, 12, 13, 14, 17, 19</b>		310

## RS3450M/10 Socket Set on Rail Juego de Vasos en Regleta



RS3450M/10	10 Pieces Set/Rail 250mm	(g)
<b>10, 11, 12, 13, 14, 15, 17, 19, 21, 22</b>		500

# 3/8" Hand Sockets

3400LH (LH-S)	D <sub>1</sub> (mm)	D <sub>2</sub> (mm)	(mm)	L (mm)	(g)	(pcs.)
5S	10.8	17.3	5	26	20	10
6S	12	17.3	5.6	26	22	10
8S	15.8	17.3	6.8	26	25	10
10S	18	17	8	26	25	10
12S	22	20	9.2	28	42	10
14S	24.5	22.5	10.4	30	51	10
16S	28	26	11.6	32	77	10

## 3400LH LHS Sockets Vasos LHS

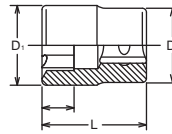

### LHSTIX®

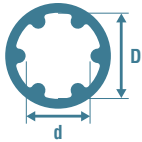

	LH-S	LH-5S	LH-6S	LH-8S	LH-10S	LH-12S	LH-14S	LH-16S
D	(ref. mm)	7.5	9.0	12.0	15.0	18.0	21.0	24.0
d	(ref. mm)	5.60	6.78	9.04	11.30	13.56	15.82	18.08

RS3400LH/7	7 Pieces Set/Rail 150mm	(g)
5S, 6S, 8S, 10S, 12S, 14S, 16S		315

## RS3400LH/7 Socket Set on Rail Juego de Vasos en Regleta



3300X 3305X (mm)	D <sub>1</sub> (mm)	D <sub>2</sub> (mm)	(mm)	L (mm)	(g)	(pcs.)
8	12	17.3	16	40	34	10
9	13	17.3	16	40	36	10
10	14.5	17.3	16	40	36	10
11	16	17.3	18	40	36	10
12	16.8	17.3	18	40	36	10
13	18	17	18	40	37	10
14	20	18	18	40	46	10
15	21	20	20	40	49	10
16	22	20	20	40	51	10
17	23.5	22	20	40	61	10
18	24.5	23	20	40	68	10
19	25	24	20	40	75	10

## 3300X · 3300XA 6-point Sockets, Semi-Deep Vasos Hexagonales, Medianos

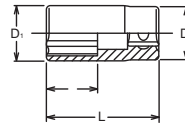

3300XA 3305XA (inch)	D <sub>1</sub> (mm)	D <sub>2</sub> (mm)	(mm)	L (mm)	(g)	(pcs.)
1/4	10.3	17.3	16	40	32	10
5/16	12	17.3	16	40	34	10
3/8	13.9	17.3	16	40	36	10
7/16	16	17.2	18	40	36	10
1/2	16.8	17	18	40	37	10
9/16	20	18.5	18	40	46	10
5/8	22	20	20	40	51	10
11/16	24.5	22.5	20	40	68	10
3/4	25	23.5	20	40	75	10

## 3305X · 3305XA 12-point Sockets, Semi-Deep Vasos Bihexagonales, Medianos

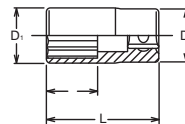

RS3300X/8	8 Pieces Set/Rail 200mm	(g)
8, 10, 11, 12, 13, 14, 17, 19		405

## RS3300X/8 Socket Set on Rail Juego de Vasos en Regleta

## RS3305X/8 Socket Set on Rail Juego de Vasos en Regleta

RS3305X/8	8 Pieces Set/Rail 200mm	(g)
8, 10, 11, 12, 13, 14, 17, 19		405



RS3300XA/9	9 Pieces Set/Rail 200mm	(g)
1/4, 5/16, 3/8, 7/16, 1/2, 9/16, 5/8, 11/16, 3/4		460

## RS3300XA/9 Socket Set on Rail Juego de Vasos en Regleta

## RS3305XA/9 Socket Set on Rail Juego de Vasos en Regleta

RS3305XA/9	9 Pieces Set/Rail 200mm	(g)
1/4, 5/16, 3/8, 7/16, 1/2, 9/16, 5/8, 11/16, 3/4		460



HAND MANUALES  
Z-SERIES  
TITANIUM DE TITANIO  
ACCESSORIES ACCESORIOS  
SCREWDRIVERS DESTORNILLADORES  
IMPACT DE IMPACTO  
SLEEVE-DRIVE INDUSTRIAL INDUSTRIALES  
AUTOMOTIVE  
CONSTRUCTION CONSTRUCCION  
RENEWAL KITS JUEGOS DE PIEZAS REPUESTO

# Hand Sockets **3/8"**

HAND  
MANUALES

Z-SERIES

TITANIUM  
DE TITANIO

ACCESSORIES  
ACCESORIOS

SCREWDRIVERS  
DESTORNILLADORES

IMPACT  
DE IMPACTO

SLEEVE-DRIVE

INDUSTRIAL  
INDUSTRIALES

AUTOMOTIVE

CONSTRUCTION  
CONSTRUCCION

RENEWAL KITS  
JUEGOS DE PIEZAS/REPLISTO

## 3300M • 3300A 6-point Deep Sockets Vasos Hexagonales Largos

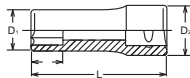

## 3305M • 3305A 12-point Deep Sockets Vasos Bihexagonales Largos

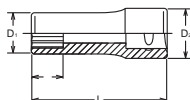

## RS3300M/8 Socket Set on Rail Juego de Vasos en Regleta

### RS3305M/8



## RS3300M/12 Socket Set on Rail Juego de Vasos en Regleta

### RS3305M/12



## RS3300A/9 Socket Set on Rail Juego de Vasos en Regleta

### RS3305A/9



3300M 3305M (mm)	D <sub>1</sub> (mm)	D <sub>2</sub> (mm)	(mm)	L (mm)	(g)	(pcs.)
New 5.5	8.9	17.3	6.5	55	37	10
6	9.9	17.3	7	55	37	10
7	10.6	17.3	8	55	37	10
8	12	17.3	9	55	40	10
9	13	17.3	10	55	42	10
10	14.5	17.3	11	55	46	10
11	16	17.3	12	55	51	10
12	16.8	17.2	13	55	52	10
13	18	17	14	55	53	10
14	20	18	16	55	60	10
15	21	20	16	55	74	10
16	22	20	17	55	76	10
17	23.5	22	18	55	93	10
18	24.5	23	19	55	98	10
19	25	24	20	55	98	10
20	26	25	21	65	126	10
21	27	26	22	65	126	10
22	29	28	23	65	163	10
23	30	29	24	65	168	10
24	31	30	25	65	191	10
New 25	33	30	26	65	199	10
New 26	34	31	27	65	209	10
27	35	32.5	28	65	218	10

3300A 3305A (inch)	D <sub>1</sub> (mm)	D <sub>2</sub> (mm)	(mm)	L (mm)	(g)	(pcs.)
1/4	9.9	17.3	7	55	37	10
5/16	12	17.3	9	55	40	10
11/32	12.3	17.3	10	55	41	10
3/8	14	17.3	11	55	46	10
7/16	16	17.3	12	55	51	10
1/2	18	17	14	55	53	10
9/16	20	18	16	55	60	10
19/32	21	20	16	55	74	10
5/8	22	20	17	55	76	10
11/16	23.5	22	18	55	93	10
3/4	25	24	20	55	98	10
13/16	27	26	22	65	126	10
7/8	29	28	23	65	163	10
15/16	31	30	25	65	191	10

RS3300M/8	8 Pieces Set/Rail 200mm	(g)
8, 10, 11, 12, 13, 14, 17, 19		540

RS3305M/8	8 Pieces Set/Rail 200mm	(g)
8, 10, 11, 12, 13, 14, 17, 19		540

RS3300M/12	12 Pieces Set/Rail 300mm	(g)
8, 9, 10, 11, 12, 13, 14, 15, 16, 17, 18, 19		878

RS3305M/12	12 Pieces Set/Rail 300mm	(g)
8, 9, 10, 11, 12, 13, 14, 15, 16, 17, 18, 19		878

RS3300A/9	9 Pieces Set/Rail 200mm	(g)
1/4, 5/16, 3/8, 7/16, 1/2, 9/16, 5/8, 11/16, 3/4		628

RS3305A/9	9 Pieces Set/Rail 200mm	(g)
1/4, 5/16, 3/8, 7/16, 1/2, 9/16, 5/8, 11/16, 3/4		628

# 3/8" Hand Sockets

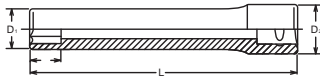

3300M-Size DEEP SOCKET

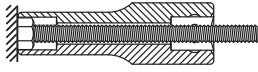

3300M-Size(L120) EXTRA DEEP SOCKET

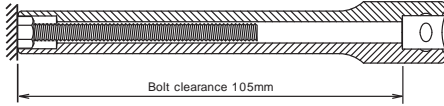

3300M(L120) 3305M(L120) (mm)	D <sub>1</sub> (mm)	D <sub>2</sub> (mm)	(mm)	L (mm)	(g)	(pcs.)
8	12	17.3	9	120	85	10
10	14.5	17.3	11	120	110	10
12	16.8	17.2	13	120	116	10
13	18	17	14	120	155	5
14	20	18	16	120	166	5

3300M/4-L120	4 Pieces Set/△=477g
PLASTIC BAG	
Sockets	
3300M(L120) 6-point Extra Deep Sockets 8, 10, 12, 14	

New 3305M/4-L120	4 Pieces Set/△=477g
PLASTIC BAG	
Sockets	
3305M(L120) 12-point Extra Deep Sockets 8, 10, 12, 14	

3310M (mm)	D <sub>1</sub> (mm)	D <sub>2</sub> (mm)	(mm)	L (mm)	(g)	(pcs.)
6	9.9	17.3	7	55	37	10
7	10.6	17.3	8	55	37	10
8	12	17.3	9	55	40	10
9	13	17.3	10	55	42	10
10	14.5	17.3	11	55	46	10
11	16	17.3	12	55	51	10
12	16.8	17.2	13	55	52	10
13	18	17	14	55	53	10
14	20	18	16	55	60	10
15	21	20	16	55	74	10
16	22	20	17	55	76	10
17	23.5	22	18	55	93	10
18	24.5	23	19	55	98	10
19	25	24	20	55	98	10
20	26	25	21	65	126	10
21	27	26	22	65	126	10
22	29	28	23	65	163	10
23	30	29	24	65	168	10
24	31	30	25	65	161	10

RS3310M/12	12 Pieces Set/Rail 300mm	(g)
8, 9, 10, 11, 12, 13, 14, 15, 16, 17, 18, 19		881

## 3300M (L120) 6-point Extra Deep Sockets Vasos Hexagonales Extra-Largos



## 3305M (L120) 12-point Extra Deep Sockets Vasos Bihexagonales Extra-Largos



## 3300M/4-L120 Socket Set Juego de Vasos

## 3305M/4-L120 Socket Set Juego de Vasos



## 3310M Surface Drive Deep Sockets Vasos Surface Drive (de Contacto Curvo) Largos

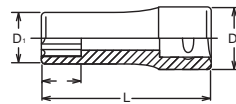

## RS3310M/12 Socket Set on Rail Juego de Vasos en Regleta



HAND  
MANUALES

Z-SERIES

TITANIUM  
DE TITANIO

ACCESSORIES  
ACCESORIOS

SCREWDRIVERS  
DESTORNILLADORES

IMPACT  
DE IMPACTO

SLEEVE-DRIVE

INDUSTRIAL  
INDUSTRIALES

AUTOMOTIVE

CONSTRUCTION  
CONSTRUCCION

RENEWAL KITS  
JUEGOS DE PIEZAS REPIESTO



# Hand Sockets 3/8"

HAND MANUALES  
Z-SERIES  
TITANIUM DE TITANIO  
ACCESSORIES ACCESORIOS  
SCREWDRIVERS DESTORNILLADORES  
IMPACT DE IMPACTO  
SLEEVE-DRIVE  
INDUSTRIAL INDUSTRIALES  
AUTOMOTIVE  
CONSTRUCTION CONSTRUCCION  
RENEWAL KITS JUEGOS DE PIEZAS REPLETO

## 3300W 6-point Deep Whitworth Sockets Vasos Whitworth Hexagonales Largos

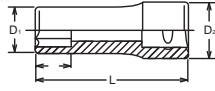

3300W 3305W (W)	D <sub>1</sub> (mm)	D <sub>2</sub> (mm)	(mm)	L (mm)	(g)	(pcs.)
1/8	12.3	17.3	10	55	46	10
3/16	16	17.3	12	55	55	10
1/4	18	17	14	55	57	10
5/16	21	20	16	55	79	10
3/8	24.5	23	19	55	96	10
7/16	27	26	22	65	140	10
1/2	30	29	24	65	193	10
9/16	34	31	27	65	250	10

## 3305W 12-point Deep Whitworth Sockets Vasos Whitworth Bihexagonales Largos

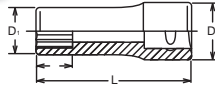

### BS W



BS-W	BS	3/16BS	1/4BS	5/16BS	3/8BS	7/16BS	1/2BS	9/16BS	5/8BS	11/16BS	3/4BS	7/8BS
	W	1/8W	3/16W	1/4W	5/16W	3/8W	7/16W	1/2W	9/16W	5/8W	11/16W	3/4W
Across Flat	(ref. mm)	8.64	11.30	13.34	15.24	18.03	20.83	23.37	25.65	27.94	30.48	33.35

## RS3300W/7 Socket Set on Rail Juego de Vasos en Regleta

## RS3305W/7



RS3300W/7	7 Pieces Set/Rail 200mm	(g)
1/8, 3/16, 1/4, 5/16, 3/8, 7/16, 1/2		719

RS3305W/7	7 Pieces Set/Rail 200mm	(g)
1/8, 3/16, 1/4, 5/16, 3/8, 7/16, 1/2		719

## 3325 TORX® Deep Sockets Vasos TORX® Largos

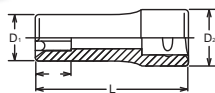

3325 (E)	D <sub>1</sub> (mm)	D <sub>2</sub> (mm)	(mm)	L (mm)	(g)	(pcs.)
E 4	5.6	17.3	4.6	55	29	10
E 5	6.9	17.3	5.2	55	31	10
E 6	7.9	17.3	5.4	55	33	10
E 7	8.9	17.3	6.6	55	36	10
E 8	9.9	17.3	7	55	39	10
E10	11.8	17.3	8.2	55	43	10
E12	14.5	17.2	9.3	55	53	10
E14	15.7	17.2	10.6	55	57	10
E16	18	17	11.8	55	69	10

### TORX® (E)



E	E4	E5	E6	E7	E8	E10	E11	E12	E14	E16	E18	E20	E22	E24	E26	E28	
S	(ref. mm)	3.83	4.72	5.69	6.17	7.47	9.37	10.03	11.12	12.85	14.71	16.64	18.41	20.24	22.10	23.85	25.65

## RS3325/9 Socket Set on Rail Juego de Vasos en Regleta



RS3325/9	9 Pieces Set/Rail 200mm	(g)
E4, E5, E6, E7, E8, E10, E12, E14, E16		420

3350M (mm)	D <sub>1</sub> (mm)	D <sub>2</sub> (mm)	(mm)	L (mm)	(g)	(pcs.)
8	12	17.3	5	55	50	10
10	14.5	17.3	6	55	54	10
12	16.8	17.3	7	55	58	10
13	18	17	8	55	59	10
14	19.5	18	8.5	55	71	10

RS3350M/5	5 Pieces set/Rail 150mm	(g)
8, 10, 12, 13, 14		322

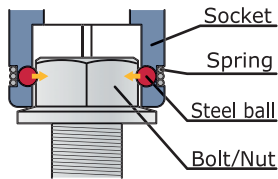
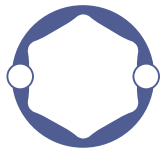

3350M(L120) (mm)	D <sub>1</sub> (mm)	D <sub>2</sub> (mm)	(mm)	L (mm)	(g)	(pcs.)
10	14.5	17.3	6	120	110	10
12	16.8	17.3	7	120	116	10

3350M/2-L120	2 Pieces Set/ 230g
PLASTIC BAG	
Sockets	
3350M(L120) Nut Grip Extra Deep Sockets 10, 12	

3300FN (mm)	D <sub>1</sub> (mm)	D <sub>2</sub> (mm)	(mm)	L (mm)	S (mm)	(g)	(pcs.)
8	14.5	17.3	6	53	6.4	38	10
9	16	17.3	7	53	6.8	41	10
10	16.8	17.2	7.5	53	7.2	42	10
11	18	17	8.5	53	8.3	42	10
12	20	18	9	53	8.8	50	10
13	21.1	20	9.5	62	9.4	66	10
14	22	20	10.5	62	10.5	66	10
15	23	22	11	70	11.5	82	10
16	24	23	11.5	70	12	90	10
17	25	24	12.5	80	13	110	10
18	27	25	13	80	13.5	120	10
19	28	26	14	80	14.5	130	10

RS3300FN/6	6 Pieces Set/Rail 150mm	(g)
8, 10, 12, 14, 17, 19		450

## 3350M Nut Grip Deep Sockets Vasos Sujeta-tuercas Largos Nut Grip®



## RS3350M/5 Socket Set on Rail Juego de Vasos en Regleta



## 3350M (L120) Extra Deep Sockets Vasos Extra-Largos Nut Grip®



## 3350M/2-L120 Socket Set Juego de Vasos



## 3300FN Flare Nut Sockets Llaves de vaso para entubar

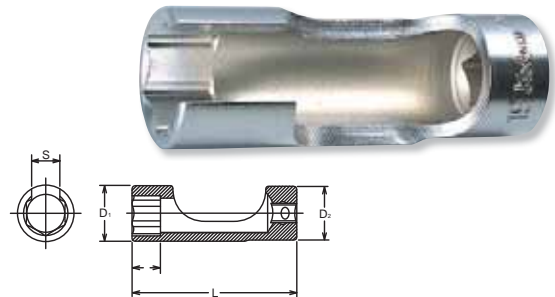

## RS3300FN/6 Socket Set on Rail Juego de Vasos en Regleta



HAND MANUALES  
Z-SERIES  
TITANIUM DE TITANIO  
ACCESSORIES ACCESORIOS  
SCREWDRIVERS DESTORNILLADORES  
IMPACT DE IMPACTO  
SLEEVE-DRIVE  
INDUSTRIAL INDUSTRIALES  
AUTOMOTIVE  
CONSTRUCTION CONSTRUCCION  
RENEWAL KITS JUEGOS DE PIEZAS REPUESTO

# Hand Sockets **3/8"**

HAND MANUALES  
Z-SERIES  
TITANIUM DE TITANIO  
ACCESSORIES ACCESORIOS  
SCREWDRIVERS DESTORNILLADORES  
IMPACT DE IMPACTO  
SLEEVE-DRIVE  
INDUSTRIAL INDUSTRIALES  
AUTOMOTIVE  
CONSTRUCTION CONSTRUCCION  
RENEWAL KITS JUEGOS DE PIEZAS/REPLISTO

## 3440M • 3440A 6-point Universal Sockets Vasos Hexagonales Universal

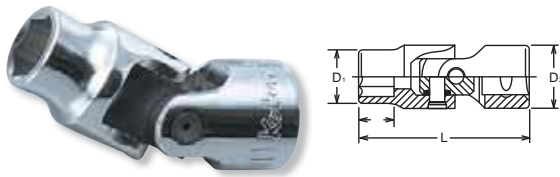

3440M 3445M (mm)	D <sub>1</sub> (mm)	D <sub>2</sub> (mm)	(mm)	L (mm)	(g)	(pcs.)
8	12	19	7.3	47	50	10
9	13.3	19	7.8	47.5	50	10
10	14.5	19	8.8	48.5	64	10
11	15.8	19	9.8	49.5	66	10
12	17	19	10.3	50	67	10
13	18.3	19	11.3	51	68	10
14	19.5	19	11.3	51	69	10
15	20.8	19	12.8	53.5	70	10
16	22	19	12.8	53.5	77	10
17	23.3	19	13.8	54.5	80	10
18	24.5	19	13.8	54.5	80	10
19	25.8	19	15.8	56.5	84	10
21	28.3	19	16.8	56.5	96	10

## 3445M • 3445A 12-point Universal Sockets Vasos Bihexagonales con Articulación Universal



3440A 3445A (inch)	D <sub>1</sub> (mm)	D <sub>2</sub> (mm)	(mm)	L (mm)	(g)	(pcs.)
5/16	12	19	7.3	47	50	10
3/8	14	19	8.3	48	64	10
7/16	15.8	19	9.8	49.5	66	10
1/2	18.3	19	11.3	51	68	10
9/16	19.5	19	11.3	51	69	10
5/8	22	19	12.8	53.5	77	10
11/16	24.5	19	13.8	54.5	80	10
3/4	25.8	19	15.8	56.5	84	10

## RS3440M/8 Socket Set on Rail Juego de Vasos en Regleta

## RS3440A /8 Socket Set on Rail



RS3440M/8	8 Pieces Set/Rail 200mm	(g)
8, 10, 11, 12, 13, 14, 17, 19		550

RS3440A/8	8 Pieces Set/Rail 200mm	(g)
5/16, 3/8, 7/16, 1/2, 9/16, 5/8, 11/16, 3/4		570

## 3445W 12-point Whitworth Universal Socket Vasos Whitworth Bihex con Articulación Universal

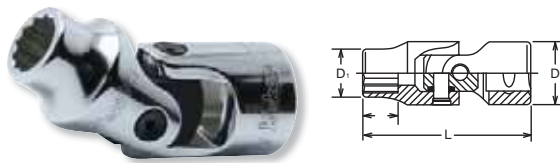

3445W (W)	D <sub>1</sub> (mm)	D <sub>2</sub> (mm)	(mm)	L (mm)	(g)	(pcs.)
New 1/8	13.3	19	7.8	47.5	50	10
New 3/16	15.8	19	9.7	49.5	66	10
New 1/4	18.3	19	11.3	51	68	10
New 5/16	20.8	19	12.8	53.5	70	10
New 3/8	24.5	19	13.8	54.5	80	10
New 7/16	28.3	19	16.8	57.5	96	10
New 1/2	30.8	19	17.8	58.5	105	10

## RS3445W/7 Socket Set on Rail Juego de Vasos en Regleta



RS3445W/7	7 Pieces Set/Rail 200mm	(g)
New 1/8, 3/16, 1/4, 5/16, 3/8, 7/16, 1/2	570	

## 3440T TORX® Universal Sockets Vasos TORX® con Articulación Universal

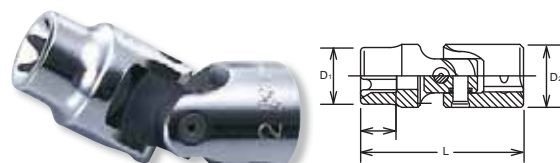

3440T (E)	D <sub>1</sub> (mm)	D <sub>2</sub> (mm)	(mm)	L (mm)	(g)	(pcs.)
E 6	7.9	19	5.4	44.5	60	10
E 8	9.9	19	7	46	63	10
E10	11.8	19	8.2	47	63	10
E12	14.5	19	9.3	48.5	68	10
E14	15.7	19	10.6	49	68	10
E16	18	19	11.8	50	70	10
E18	19.5	19	13	53	78	10
E20	22	19	14.4	54	81	10

## RS3440T/8 Socket Set on Rail Juego de Vasos en Regleta



RS3440T/8	8 Pieces Set/Rail 200mm	(g)
E6, E8, E10, E12, E14, E16, E18, E20		594

3441M (mm)	D <sub>1</sub> (mm)	D <sub>2</sub> (mm)	(mm)	L (mm)	(g)	(pcs.)
8	12	19	5	46	57	10
10	14.5	19	6	46	58	10
12	16.8	19	7	47	58	10
13	18	19	8	48	60	10
14	19.5	19	8.5	49.5	65	10



RS3441M/5	5 Pieces Set/Rail 150mm	(g)
8, 10, 12, 13, 14		320

3340M.75 (mm)	D <sub>1</sub> (mm)	D <sub>2</sub> (mm)	(mm)	L (mm)	(g)	(pcs.)
8	12	19	9	75	82	10
10	14.5	19	11	75	87	10
11	15.8	19	12	75	87	10
12	17	19	13	75	92	10
13	18.3	19	14	75	93	10
14	19.5	19	15	75	103	10
15	20.8	19	16	75	104	10
16	22	19	17	75	110	10
17	23.3	19	18	75	115	10
18	24.5	19	19	75	119	10
19	25.8	19	20	75	123	10

RS3340M/8-L75	8 Pieces Set/Rail 200mm	(g)
8, 10, 11, 12, 13, 14, 17, 19		810

3430M (mm)	D (mm)	(mm)	L (mm)	(g)	(pcs.)
5	19	15.5	62	66	10
6	19	15.5	62	70	10
7	19	15.5	62	72	10
8	19	15.5	62	74	10
10	19	15.5	62	78	10
12	19	15.5	62	85	10

RS3430M/6	6 Pieces Set/Rail 150mm	(g)
5, 6, 7, 8, 10, 12		470

## 3441M Nut Grip Universal Sockets **Nut Grip®** Vasos Sujeta-Tuercas con Articulación Universal

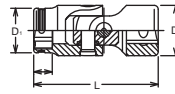

## RS3441M/5 Socket Set on Rail Juego de Vasos en Regleta



## 3340M-75 Universal Deep Sockets Vasos Largos con Articulación Universal

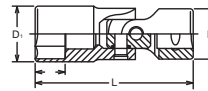

## RS3340M/8-L75 Socket Set on Rail Juego de Vasos en Regleta



## 3430M Universal Inhex Bit Sockets Vasos Inhex con Articulación Universal

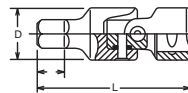

## RS3430M/6 Socket Set on Rail Juego de Vasos en Regleta





# Hand Sockets **3/8"**

HAND MANUALES  
Z-SERIES  
TITANIUM DE TITANIO  
ACCESSORIES ACCESORIOS  
SCREWDRIVERS DESTORNILLADORES  
IMPACT DE IMPACTO  
SLEEVE-DRIVE  
INDUSTRIAL INDUSTRIALES  
AUTOMOTIVE  
CONSTRUCTION CONSTRUCCION  
RENEWAL KITS JUEGOS DE PIEZAS REPLUESTO

## 3117M-125 · -250 Extension Deep Sockets Vasos con Alargadera

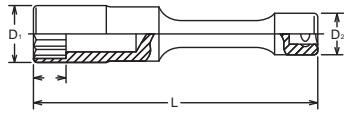

3117M.125 (mm)	D <sub>1</sub> (mm)	D <sub>2</sub> (mm)	(mm)	L (mm)	(g)	(pce.)
10	14.5	18	10	125	121	1
11	16	18	11	125	133	1
12	17	18	12	125	133	1
13	18	18	13	125	134	1
14	19.5	18	14	125	145	1
17	23.5	18	17	125	178	1
19	25	18	19	125	187	1
21	27	18	21	125	195	1
22	29	18	22	125	214	1

3117M.250 (mm)	D <sub>1</sub> (mm)	D <sub>2</sub> (mm)	(mm)	L (mm)	(g)	(pce.)
10	14.5	18	10	250	233	1
11	16	18	11	250	241	1
12	17	18	12	250	246	1
13	18	18	13	250	249	1
14	19.5	18	14	250	262	1
17	23.5	18	17	250	289	1
19	25	18	19	250	298	1
21	27	18	21	250	302	1
22	29	18	22	250	325	1

## 3000-60 (PH) Phillips Bit Sockets Vasos con Punta Phillips

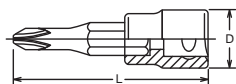

3000 (PH)	D (mm)	L (mm)	(g)	(pcs.)
1	18	60	49	10
2	18	60	49	10
3	18	60	49	10
4	18	60	50	10

## 3000-50 (PZ) PZ Bit Sockets Vasos con Punta PZ

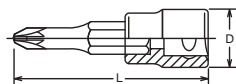

3000.50 (PZ)	D (mm)	L (mm)	(g)	(pcs.)
PZ1	18	50	50	10
PZ2	18	50	50	10
PZ3	18	50	50	10

## 3005-60 Slotted Bit Sockets Vasos con Punta Recta para Cabeza Ranurada

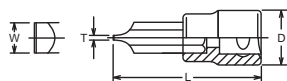

3005	TxW (mm)	D (mm)	L (mm)	(g)	(pcs.)
5	1.0x 5.5	18	60	47	10
8	1.2x 8	18	60	49	10
10	1.6x10	20	60	85	10

# 3/8" Hand Sockets

## 3010M-38 · -62 · -100 · -160 Inhex Bit Sockets Vasos con Punta Hexagonal

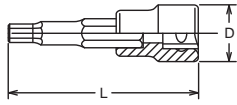

3010M.38 (mm)	D (mm)	L (mm)	(g)	(pcs.)
3	18	38	27	10
4	18	38	28	10
5	18	38	30	10
6	18	38	31	10
7	18	38	32	10
8	18	38	33	10
New 9	20	38	47	10
New 10	20	38	48	10
New 11	20	38	59	10
12	20	38	60	10
13	22	38	76	10
14	22	38	78	10

3010M.62 (mm)	D (mm)	L (mm)	(g)	(pcs.)
3	18	62	43	10
4	18	62	45	10
5	18	62	48	10
6	18	62	49	10
7	18	62	50	10
8	18	62	62	10
New 9	20	62	75	10
New 10	20	62	76	10
New 11	20	62	92	10
12	20	62	94	10
13	22	62	107	10
14	22	62	109	10

3010M.100 (mm)	D (mm)	L (mm)	(g)	(pcs.)
3	18	100	58	10
4	18	100	60	10
5	18	100	63	10
6	18	100	64	10
7	18	100	66	10
8	18	100	69	10
New 9	20	100	100	10
New 10	20	100	102	10
New 11	20	100	129	10
12	20	100	131	10
13	22	100	158	5
14	22	100	160	5

3010M.160 (mm)	D (mm)	L (mm)	(g)	(pcs.)
3	18	160	84	10
4	18	160	86	10
5	18	160	89	10
6	18	160	90	10
7	18	160	92	10
8	18	160	95	10
New 9	20	160	125	10
New 10	20	160	128	10
New 11	20	160	153	10
12	20	160	157	10
13	22	160	237	5
14	22	160	239	5

RS3010M/8-L38	8 Pieces Set/Rail 200mm	(g)
3, 4, 5, 6, 7, 8, 10, 12		322

RS3010M/8-L62	8 Pieces Set/Rail 200mm	(g)
3, 4, 5, 6, 7, 8, 10, 12		490















RS3010M/8-L100	8 Pieces Set/Rail 200mm	(g)
3, 4, 5, 6, 7, 8, 10, 12		645

## RS3010M/8-L38 Socket Set on Rail Juego de Vasos en Regleta

## RS3010M/8-L62

## RS3010M/8-L100



	 Phillips (PH)	 PZ	 Slotted	 HEX	 HEX (ball point)	 Triple Square (XZN)	 TORX® (T)	 TORX® (TH)	 TORXplus® (IP)	 Penta-Lobe (PR)	 Ribe-CV
 1/4"	No.2000 series	No.2000(PZ) series	No.2005 series	No.2010M/A series	No.2011M series	No.2020 series	No.2025 series	No.2025(TH) series	No.2025(IP) series	No.2025(PR) series	—
 3/8"	No.3000 No.3001 series	No.3000(PZ) series	No.3005 No.3006 series	No.3010M No.3012M/A No.3015M series	No.3011M series	No.3020 series	No.3025 series	No.3025(TH) series	No.3025(IP) series	No.3025(PR) series	No.3027 series
 1/2"	No.4000 No.4001 series	No.4000(PZ) series	No.4005 No.4006 series	No.4010M No.4012M/A series	—	No.4020 series	No.4025 series	—	No.4025(IP) series	—	No.4027 series

HAND MANUALES  
Z-SERIES  
TITANIUM DE TITANIO  
ACCESSORIES ACCESORIOS  
SCREWDRIVERS DESTORNILLADORES  
IMPACT DE IMPACTO  
SLEEVE-DRIVE INDUSTRIAL INDUSTRIALES  
AUTOMOTIVE  
CONSTRUCTION CONSTRUCCION  
RENEWAL KITS JUEGOS DE PIEZAS REPUESTO

# Hand Sockets **3/8"**

HAND  
MANUALES

Z-SERIES

TITANIUM  
DE TITANIO

ACCESSORIES  
ACCESORIOS

SCREWDRIVERS  
DESTORNILLADORES

IMPACT  
DE IMPACTO

SLEEVE-DRIVE

INDUSTRIAL  
INDUSTRIALES

AUTOMOTIVE

CONSTRUCTION  
CONSTRUCCION

RENEWAL KITS  
JUEGOS DE PIEZAS REPLUSTO

## 3011M-62 · -100 · -120 · -160

Ballpoint Inhex Sockets  
Vasos con Punta de Bola Inhex

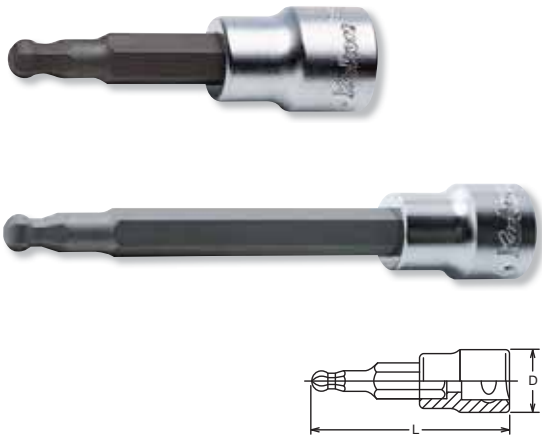

3011M.62 (mm)	D (mm)	L (mm)	(g)	(pcs.)
3	18	62	45	10
4	18	62	46	10
5	18	62	48	10
6	18	62	49	10
7	18	62	50	10
8	18	62	51	10

3011M.100 (mm)	D (mm)	L (mm)	(g)	(pcs.)
3	18	100	61	10
4	18	100	62	10
5	18	100	64	10
6	18	100	65	10
7	18	100	67	10
8	18	100	68	10

3011M.120 (mm)	D (mm)	L (mm)	(g)	(pcs.)
3	18	120	77	10
4	18	120	78	10
5	18	120	80	10
6	18	120	81	10
7	18	120	83	10
8	18	120	84	10

3011M.160 (mm)	D (mm)	L (mm)	(g)	(pcs.)
3	18	160	87	10
4	18	160	88	10
5	18	160	89	10
6	18	160	91	10
7	18	160	93	10
8	18	160	95	10

Ball point bit sockets have less strength due to the special design. Make sure to use them correctly.

## 3015M-62 · -100

Inhex Bit Sockets, Grip Ring  
Vasos con Punta Hexagonal, Grip Ring



3015M.62 (mm)	D (mm)	L (mm)	(g)	(pcs.)
3	18	62	43	10
4	18	62	45	10
5	18	62	50	10
6	18	62	50	10
7	18	62	50	10
8	18	62	62	10
10	20	62	75	10
12	20	62	95	10

3015M.100 (mm)	D (mm)	L (mm)	(g)	(pcs.)
3	18	100	60	10
4	18	100	60	10
5	18	100	65	10
6	18	100	65	10
7	18	100	70	10
8	18	100	70	10
10	20	100	105	10
12	20	100	135	10

Grip Ring holds hex screws

## RS3015M/8-L62

Socket Set on Rail  
Juego de Vasos en Regleta

## RS3015M/8-L100



RS3015M/8-L62	8 Pieces Set/Rail 200mm	(g)
3, 4, 5, 6, 7, 8, 10, 12		500

RS3015M/8-L100	8 Pieces Set/Rail 200mm	(g)
3, 4, 5, 6, 7, 8, 10, 12		650

# 3/8" Hand Sockets

## 3020-38 · -50 · -100 · -120 XZN Bit Sockets Vasos con punta XZN

3020.38 (XZN)	D (mm)	L (mm)	(g)	(pcs.)
M 5	18	38	32	10
M 6	18	38	33	10
M 8	18	38	36	10
M10	20	38	51	10
M12	20	38	52	10
M14	22	38	74	10

3020.50 (XZN)	D (mm)	L (mm)	(g)	(pcs.)
M 4	18	50	35	10
M 5	18	50	37	10
M 6	18	50	39	10
M 8	18	50	40	10
M10	20	50	65	10
M12	20	50	69	10
M14	22	50	75	10

3020.100 (XZN)	D (mm)	L (mm)	(g)	(pcs.)
M 4	18	100	57	10
M 5	18	100	59	10
M 6	18	100	61	10
M 8	18	100	62	10
M10	20	100	99	10
M12	20	100	103	10
M14	22	100	145	5

3020.120 (XZN)	D (mm)	L (mm)	(g)	(pcs.)
M 4	18	120	77	10
M 5	18	120	79	10
M 6	18	120	81	10
M 8	18	120	82	10
M10	20	120	119	10
M12	20	120	123	10
M14	22	120	165	5

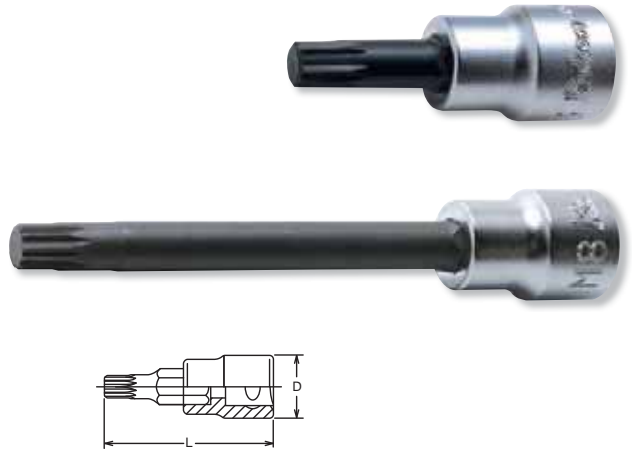

**XZN**



XZN		M4	M5	M6	M8	M10	M12	M14	M16	M18
S	(ref. mm)	3.60	4.80	6.00	7.20	9.60	11.41	13.22	15.63	16.85

RS3020/6-L38	6 Pieces Set/Rail 150mm	 (g)
M5, M6, M8, M10, M12, M14		308

## RS3020/6-L38 Socket Set on Rail Juego de Vasos en Regleta



RS3020/7-L50	7 Pieces Set/Rail 200mm	 (g)
M4, M5, M6, M8, M10, M12, M14		400

## RS3020/7-L50 Socket Set on Rail Juego de Vasos en Regleta



HAND MANUALES  
Z-SERIES  
TITANIUM DE TITANIO  
ACCESSORIES ACCESORIOS  
SCREWDRIVERS DESTORNILLADORES  
IMPACT DE IMPACTO  
SLEEVE-DRIVE  
INDUSTRIAL INDUSTRIALES  
AUTOMOTIVE  
CONSTRUCTION CONSTRUCCION  
RENEWAL KITS JUEGOS DE PIEZAS REPIESTO



# Hand Sockets **3/8"**

HAND MANUALES  
Z-SERIES  
TITANIUM DE TITANIO  
ACCESSORIES ACCESORIOS  
SCREWDRIVERS DESTORNILLADORES  
IMPACT DE IMPACTO  
SLEEVE-DRIVE  
INDUSTRIAL INDUSTRIALES  
AUTOMOTIVE  
CONSTRUCTION CONSTRUCCION  
RENEWAL KITS JUEGOS DE PIEZAS REPLUESTO

## 3025-38 · -50 · -140 (T)

 TORX® Bit Sockets  
Vasos con Punta TORX®

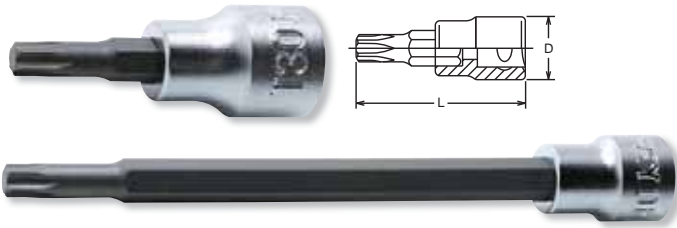

3025.38 (T)	D (mm)	L (mm)	(g)	(pcs.)
T 9	18	38	32	10
T10	18	38	32	10
T15	18	38	33	10
T20	18	38	33	10
T25	18	38	33	10
T27	18	38	33	10
T30	18	38	33	10
T40	18	38	34	10
T45	18	38	37	10
T50	20	38	49	10
T55	20	38	57	10

3025.50 (T)	D (mm)	L (mm)	(g)	(pcs.)
T 9	18	50	36	10
T10	18	50	36	10
T15	18	50	36	10
T20	18	50	36	10
T25	18	50	37	10
T27	18	50	37	10
T30	18	50	38	10
T40	18	50	39	10
T45	18	50	41	10
T50	20	50	55	10
T55	20	50	67	10

3025.140 (T)	D (mm)	L (mm)	(g)	(pcs.)
T 9	18	140	75	10
T10	18	140	75	10
T15	18	140	75	10
T20	18	140	75	10
T25	18	140	76	10
T27	18	140	76	10
T30	18	140	77	10
T40	18	140	78	10
T45	18	140	80	10
T50	20	140	94	10
T55	20	140	106	10

TORX®  
(T)

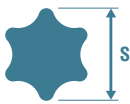

T	T8	T9	T10	T15	T20	T25	T27	T30	T40	T45	T50	T55	T60	T70	T80	T90	T100
S (ref. mm)	2.30	2.48	2.72	3.26	3.84	4.40	4.96	5.49	6.60	7.77	8.79	11.17	13.20	15.49	17.51	19.88	22.09

## RS3025/8-L38

  Socket Set on Rail  
Juego de Vasos en Regleta

## RS3025/8-L50



RS3025/8-L38	8 Pieces Set/Rail 200mm	(g)
T10, T15, T20, T25, T27, T30, T40, T45		300

RS3025/8-L50	8 Pieces Set/Rail 200mm	(g)
T10, T15, T20, T25, T27, T30, T40, T45		320

## 3025-50-T35

 Bit Socket  
Vasos con Punta



3025.50 (T)	D (mm)	L (mm)	(g)	(pcs.)
<b>T35</b>	18	50	39	10

## 3025-100R (T)

 TORX® Bit Sockets, Round Shaft  
Vasos con Punta TORX®

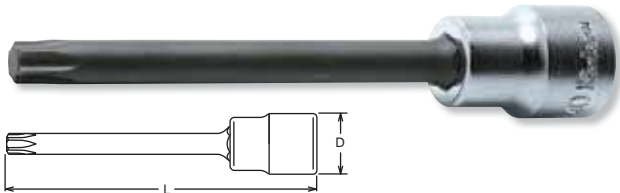

3025.100R (T)	D (mm)	L (mm)	(g)	(pcs.)
T20	18	100	38	10
T25	18	100	40	10
T27	18	100	42	10
T30	18	100	45	10
T40	18	100	52	10
T45	18	100	73	10
T50	20	100	80	10
T55	20	100	106	10

## RS3025/8-L100R

  Socket Set on Rail  
Juego de Vasos en Regleta



RS3025/8-L100R	8 Pieces Set/Rail 200mm	(g)
T20, T25, T27, T30, T40, T45, T50, T55		490

3025.50 (TH)	D (mm)	L (mm)	(g)	(pcs.)
T10H	18	50	37	10
T15H	18	50	38	10
T20H	18	50	38	10
T25H	18	50	38	10
T27H	18	50	38	10
T30H	18	50	39	10
T40H	18	50	40	10
T45H	18	50	41	10
T50H	20	50	61	10
T55H	20	50	61	10

3025.160 (TH)	D (mm)	L (mm)	(g)	(pcs.)
T25H	18	160	83	10
T27H	18	160	83	10
T30H	18	160	84	10
T40H	18	160	85	10
T45H	18	160	86	10
T50H	20	160	128	10
T55H	20	160	128	10

RS3025/9-HOLE	9 Pieces Set/Rail 200mm	(g)
T10H, T15H, T20H, T25H, T27H, T30H, T40H, T45H, T50H		405

3247	4 Pieces Set/PLASTIC BAG	(g)
Sockets 3025.160 Tamper-Resistant TORX® Bit Sockets T27H, T30H, T40H, T50H		385g

3025.100R (TH)	D (mm)	L (mm)	(g)	(pcs.)
T20H	18	100	38	10
T25H	18	100	40	10
T27H	18	100	42	10
T30H	18	100	45	10
T40H	18	100	52	10
T45H	18	100	73	10
T50H	20	100	80	10
T55H	20	100	106	10

RS3025/8-L100RH	8 Pieces Set/Rail 200mm	(g)
T20H, T25H, T27H, T30H, T40H, T45H, T50H, T55H		490

## 3025-50 · -160 (TH) ⚠

Tamper-Resistant TORX® Bit Sockets  
Vasos con Punta TORX® Indeformable

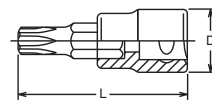

⚠ Tamper Resistant TORX® Bit Sockets have less strength due to special design. Make sure to use it correctly.  
Los Vasos con Punta Indeformable TORX® tienen menos resistencia debido al diseño especial. Asegurarse de su correcta utilización.



## RS3025/9-HOLE Socket Set on Rail Juego de Vasos en Regleta



## 3247 Bit Socket Set Juego de Vasos con Punta



## 3025-100R (TH) Tamper-Resistant TORX® Bit Sockets, Round Shaft Vasos con Punta TORX® Indeformable

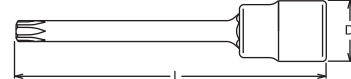

## RS3025/8-L100RH Socket Set on Rail Juego de Vasos en Regleta



# Hand Sockets **3/8"**

HAND MANUALES  
Z-SERIES  
TITANIUM DE TITANIO  
ACCESSORIES ACCESORIOS  
SCREWDRIVERS DESTORNILLADORES  
IMPACT DE IMPACTO  
SLEEVE-DRIVE  
INDUSTRIAL INDUSTRIALES  
AUTOMOTIVE  
CONSTRUCTION CONSTRUCCION  
RENEWAL KITS JUEGOS DE PIEZAS REPLÉSTO

## 3025-50 (IP)

 TORX PLUS® Bit Sockets  
Vasos con Punta TORX PLUS®



3025.50 (IP)	D (mm)	L (mm)	(g)	(pcs.)
10IP	18	50	38	10
15IP	18	50	38	10
20IP	18	50	38	10
25IP	18	50	38	10
27IP	18	50	40	10
30IP	18	50	40	10
40IP	18	50	41	10
45IP	18	50	41	10
50IP	20	50	61	10
55IP	20	50	61	10

TORXplus® (IP)



IP	8IP	9IP	10IP	15IP	20IP	25IP	27IP	30IP	40IP	45IP	50IP	55IP	60IP	70IP
S (ref. mm)	2.29	2.48	2.72	3.25	3.84	4.39	4.95	5.49	6.60	7.77	8.79	11.16	13.20	15.49

## RS3025/8-IP

 Socket Set on Rail  
Juego de Vasos en Regleta



RS3025/8-IP	8 Pieces Set/Rail 200mm	(g)
	20IP, 25IP, 27IP, 30IP, 40IP, 45IP, 50IP, 55IP	370

## RSX025/11-IP

 Socket Set on Rail  
Juego de Vasos en Regleta



RSX025/11-IP	11 Pieces Set/Rail 200mm	(g)
2025.28(IP)	10IP, 15IP, 20IP, 25IP, 27IP	480
3025.50(IP)	30IP, 40IP, 45IP, 50IP	
4025.60(IP)	55IP, 60IP	

$1/4" + 3/8" + 1/2"$

## 3025-50 (PR)

 Penta-Lobe Bit Sockets, with hole  
Vasos con Punta de Cinco Lóbulos, con agujero



3025.50 (PR)	D (mm)	L (mm)	(g)	(pcs.)
10PR	18	50	38	10
15PR	18	50	38	10
20PR	18	50	38	10
25PR	18	50	38	10
27PR	18	50	40	10
30PR	18	50	40	10
40PR	18	50	41	10
45PR	18	50	41	10
50PR	20	50	61	10
55PR	20	50	61	10

Penta-Lobe (PR)



PR	8PR	9PR	10PR	15PR	20PR	25PR	27PR	30PR	40PR	45PR	50PR	55PR
S (ref. mm)	2.19	2.36	2.58	3.10	3.64	4.12	4.71	5.23	6.30	7.38	8.35	10.63

## RS3025/9-PR

 Socket Set on Rail  
Juego de Vasos en Regleta



RS3025/9-PR	9 Pieces Set/Rail 200mm	(g)
	10PR, 15PR, 20PR, 25PR, 27PR, 30PR, 40PR, 45PR, 50PR	395

## RSX025/11-PR

 Socket Set on Rail  
Juego de Vasos en Regleta



RSX025/11-PR	11 Pieces Set/Rail 200mm	(g)
2025.28(PR)	8PR, 10PR, 15PR, 20PR, 25PR, 27PR, 30PR	320
3025.50(PR)	40PR, 45PR, 50PR, 55PR	

$1/4" + 3/8"$

# 3/8" Hand Sockets

3027.50	D (mm)	L (mm)	(g)	(pcs.)
M 5	18	50	38	10
M 6	18	50	38	10
M 7	18	50	38	10
M 8	18	50	39	10
M 9	20	50	40	10
M10	20	50	40	10
M12	20	50	41	10

3027.100	D (mm)	L (mm)	(g)	(pcs.)
M 5	18	100	40	10
M 6	18	100	42	10
M 8	18	100	45	10
M10	20	100	52	10
M12	20	100	73	10

## 3027-50 · -100

Bit Sockets for Ribe Screws  
Vasos con Punta Ribe

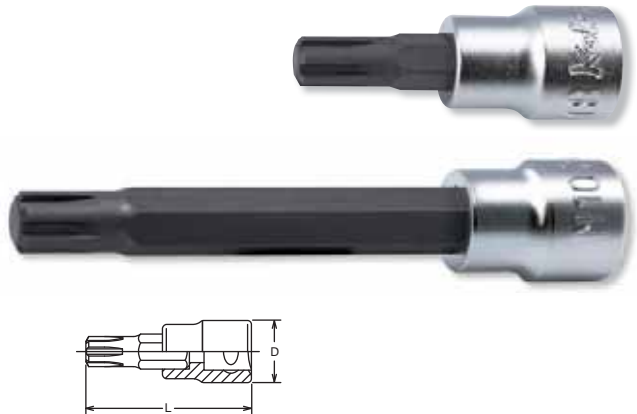

### Ribe CV

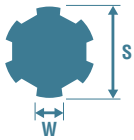

CV		M5	M6	M7	M8	M9	M10	M12	M13	M14	M16
S	(ref. mm)	5	6	7	8	9	10	12	13	14	16
W	(ref. mm)	1.1	1.3	1.4	1.7	1.9	2.2	2.6	3.0	3.1	3.5

RS3027/5-L50	5 Pieces Set/Rail 150mm	(g)
<b>M5, M6, M8, M10, M12</b>		240

## RS3027/5-L50

Socket Set on Rail  
Juego de Vasos en Regleta



3001 (PH)	D (mm)	L (mm)	(g)	(pcs.)
2	18	60	38	10
3	18	60	38	10
4	18	60	38	10

## 3001

Phillips Bit Sockets  
Vasos con Punta Phillips

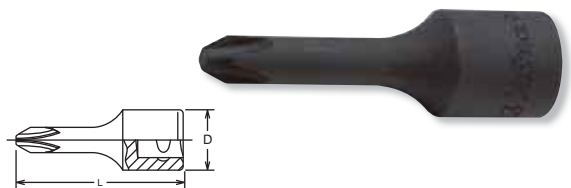

3006	TxW (mm)	D (mm)	L (mm)	(g)	(pcs.)
5	1.0x 5	18	60	35	10
8	1.2x 8	18	60	42	10
10	1.6x10	20	60	50	10

## 3006

Slotted Bit Sockets  
Vasos con Punta Recta para Cabeza Ranurada

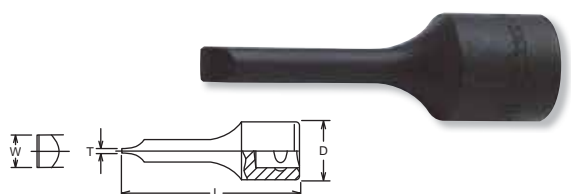

3001, 3006 are for hand use only.  
Do not use with a power or impact wrench.

HAND  
MANUALES

Z-SERIES

TITANIUM  
DE TITANIO

ACCESSORIES  
ACCESORIOS

SCREWDRIVERS  
DESTORNILLADORES

IMPACT  
DE IMPACTO

SLEEVE-DRIVE

INDUSTRIAL  
INDUSTRIALES

AUTOMOTIVE

CONSTRUCTION  
CONSTRUCCION

RENEWAL KITS  
JUEGOS DE PIEZAS REPUESTO



# Hand Sockets **3/8"**

HAND MANUALES  
Z-SERIES  
TITANIUM DE TITANIO  
ACCESSORIES ACCESORIOS  
SCREWDRIVERS DESTORNILLADORES  
IMPACT DE IMPACTO  
SLEEVE-DRIVE  
INDUSTRIAL INDUSTRIALES  
AUTOMOTIVE  
CONSTRUCTION CONSTRUCCION  
RENEWAL KITS JUEGOS DE PIEZAS REPLUSTO

## 3012M-52 · -62 · -75 3012A-52 · -62 · -75

Inhex Sockets  
Vasos con Punta de Hexagonal

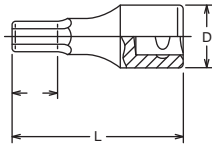

3012M/A are for hand use only.  
Do not use with a power or impact wrench.

3012M.52 (mm)	D (mm)	(mm)	L (mm)	(g)	(pcs.)
3	18	10	52	35	10
4	18	15.5	52	38	10
5	18	15.5	52	40	10
6	18	15.5	52	42	10
7	18	15.5	52	46	10
8	18.5	15.5	52	50	10
9	18.5	15.5	52	55	10
10	20	15.5	52	66	10
11	20	15.5	52	72	10
12	20	15.5	52	77	10
13	20	15.5	52	82	10
14	20	15.5	52	89	10

3012M.62 (mm)	D (mm)	(mm)	L (mm)	(g)	(pcs.)
3	18	10	62	38	10
4	18	15.5	62	40	10
5	18	15.5	62	43	10
6	18	15.5	62	46	10
7	18	15.5	62	53	10
8	18.5	15.5	62	58	10
9	18.5	15.5	62	63	10
10	20	15.5	62	77	10
11	20	15.5	62	83	10
12	20	15.5	62	90	10
13	20	15.5	62	95	10
14	20	15.5	62	109	10

3012M.75 (mm)	D (mm)	(mm)	L (mm)	(g)	(pcs.)
3	18	10	75	41	10
4	18	15.5	75	43	10
5	18	15.5	75	48	10
6	18	15.5	75	53	10
7	18	15.5	75	58	10
8	18.5	15.5	75	72	10
9	18.5	15.5	75	92	10
10	20	15.5	75	114	10
11	20	15.5	75	120	10
12	20	15.5	75	127	10
13	20	15.5	75	132	10
14	20	15.5	75	146	10

3012A.52 (inch)	D (mm)	(mm)	L (mm)	(g)	(pcs.)
1/8	18	10	52	35	10
5/32	18	15.5	52	38	10
3/16	18	15.5	52	40	10
7/32	18	15.5	52	42	10
1/4	18	15.5	52	44	10
9/32	18	15.5	52	46	10
5/16	18.5	15.5	52	50	10
11/32	18.5	15.5	52	55	10
3/8	20	15.5	52	65	10
7/16	20	15.5	52	72	10
1/2	20	15.5	52	82	10
9/16	20	15.5	52	89	10

3012A.62 (inch)	D (mm)	(mm)	L (mm)	(g)	(pcs.)
1/8	18	10	62	38	10
5/32	18	15.5	62	40	10
3/16	18	15.5	62	43	10
7/32	18	15.5	62	46	10
1/4	18	15.5	62	48	10
9/32	18	15.5	62	53	10
5/16	18.5	15.5	62	58	10
11/32	18.5	15.5	62	63	10
3/8	20	15.5	62	73	10
7/16	20	15.5	62	83	10
1/2	20	15.5	62	95	10
9/16	20	15.5	62	109	10

3012A.75 (inch)	D (mm)	(mm)	L (mm)	(g)	(pcs.)
1/8	18	10	75	41	10
5/32	18	15.5	75	43	10
3/16	18	15.5	75	48	10
7/32	18	15.5	75	53	10
1/4	18	15.5	75	53	10
9/32	18	15.5	75	58	10
5/16	18.5	15.5	75	72	10
11/32	18.5	15.5	75	92	10
3/8	20	15.5	75	110	10
7/16	20	15.5	75	120	10
1/2	20	15.5	75	132	10
9/16	20	15.5	75	146	10

## RS3012M/8-L52 RS3012A /8-L52

Socket Set on Rail  
Juego de Vasos en Regleta



RS3012M/8-L52	8 Pieces Set/Rail 200mm	(g)
3, 4, 5, 6, 7, 8, 10, 12		394

RS3012A/8-L52	8 Pieces Set/Rail 200mm	(g)
1/8, 5/32, 3/16, 7/32, 1/4, 5/16, 3/8, 1/2		425

## 2749PS-3/8 Reversible Ratchet Short Llave de Carraca Reversible Corta ⚠



\* Renewal Kits → 2749RK-3/8 → P276

	D (mm)	T (mm)	H (mm)	L (mm)	(g)	(pcs.)
2749PS-3/8	25	21.9	11.2	75	70	10

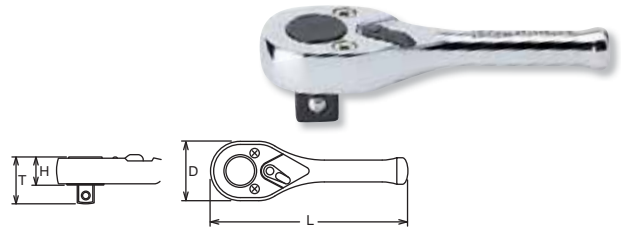

## 2749N-3/8 Reversible Ratchet Llave de Carraca Reversible ⚠



\* Renewal Kits → 2749RK-3/8 → P276



## 2749P-3/8 Reversible Ratchet Llave de Carraca Reversible ⚠



\* Renewal Kits → 2749RK-3/8 → P276

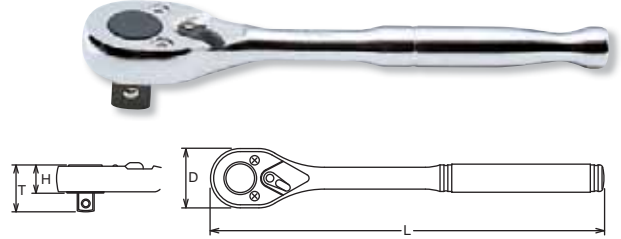

	D (mm)	T (mm)	H (mm)	L (mm)	(g)	(pcs.)
2749N-3/8	25	21.9	11.2	125	104	10
2749P-3/8	25	21.9	11.2	125	101	10

⚠ 2749-3/8 series have less strength compared with normal ratchet due to the technical design. Make sure to use the ratchet correctly.

## 3749S Reversible Ratchet Short Llave de Carraca Reversible Corta



\* Renewal Kits → 3749RK → P276



## 3749SB Reversible Ratchet with quick release button Short Llave de Carraca Reversible con botón de extracción rápida Corta ⚠



\* Renewal Kits → 3749BRK → P276

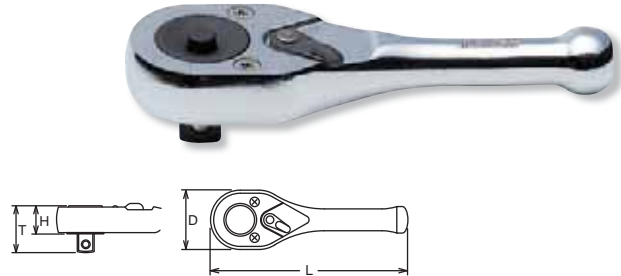

	D (mm)	T (mm)	H (mm)	L (mm)	(g)	(pcs.)
3749S	34	24.8	14.1	110	183	5
3749SB	34	24.8	14.1	110	183	5

⚠ Reversible Ratchet with quick release button has less strength compared with normal ratchet due to the technical design. Make sure to use the ratchet correctly.

## 3749N Reversible Ratchet Llave de Carraca Reversible



\* Renewal Kits → 3749RK → P276

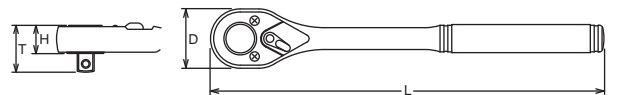

	D (mm)	T (mm)	H (mm)	L (mm)	(g)	(pcs.)
3749N	34	24.8	14.1	200	340	1

# Hand Sockets **3/8"**

HAND MANUALES  
Z-SERIES  
TITANIUM DE TITANIO  
ACCESSORIES ACCESORIOS  
SCREWDRIVERS DESTORNILLADORES  
IMPACT DE IMPACTO  
SLEEVE-DRIVE  
INDUSTRIAL INDUSTRIALES  
AUTOMOTIVE  
CONSTRUCTION CONSTRUCCION  
RENEWAL KITS JUEGOS DE PIEZAS REPLÉSTO

**3752N** Reversible Ratchet  
Llave de Carraca Reversible



\* Renewal Kits → **3752RK** → P276



**[L/R Marking]**



A pointer and L/R markings on the ratchet head indicate the turning direction.  
The reduced diameter of the head allows easier access in tight spots.

Una flecha y unas marcas L/R en el cabezal de la llave (L = izquierda / R = Derecha) indican el sentido de giro.  
El diámetro reducido del cabezal permite un acceso más fácil en lugares estrechos.

**3752J** Reversible Ratchet  
Llave de Carraca Reversible



\* Renewal Kits → **3752RK** → P276

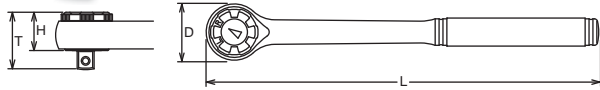

	D (mm)	T (mm)	H (mm)	L (mm)	(g)	(pce.)
<b>3752N</b>	33	34.3	23.9	200	310	1
<b>3752J</b>	33	34.3	23.9	200	310	1

**3776N** Swivel Head Ratchet  
Llave de Carraca de Cabeza Giratoria



\* Renewal Kits → **3752RK** → P276



**3776P** Swivel Head Ratchet  
Llave de Carraca de Cabeza Giratoria



\* Renewal Kits → **3752RK** → P276



**3776J** Swivel Head Ratchet  
Llave de Carraca de Cabeza Giratoria



\* Renewal Kits → **3752RK** → P276

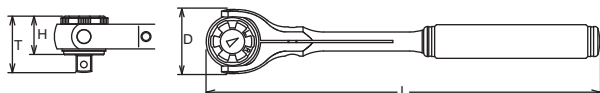

	D (mm)	T (mm)	H (mm)	L (mm)	(g)	(pce.)
<b>3776N</b>	44	34.3	23.9	280	565	1
<b>3776P</b>	44	34.3	23.9	280	560	1
<b>3776J</b>	44	34.3	23.9	280	510	1

HAND MANUALES  
Z-SERIES  
TITANIUM DE TITANIO  
ACCESSORIES ACCESORIOS  
SCREWDRIVERS DESTORNILLADORES  
IMPACTO DE IMPACTO  
SLEEVE-DRIVE SLEEVES-DRIVE  
INDUSTRIAL INDUSTRIALES  
AUTOMOTIVE  
CONSTRUCTION CONSTRUCCION  
RENEWAL KITS JUEGOS DE PIEZAS REPUESTO

## 3753SM Multi Purpose Ratchet, Reversible Llave de Carraca de Aplicación General, Reversible



\* Renewal Kits → 3753RK → P276

	D (mm)	T (mm)	H (mm)	L (mm)	(g)	(pcs.)
3753SM	30.5	26.4	15.7	81	175	5

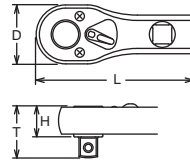

## 3753N Reversible Ratchet Llave de Carraca Reversible



\* Renewal Kits → 3753RK → P276



## 3753P Reversible Ratchet Llave de Carraca Reversible



\* Renewal Kits → 3753RK → P276



## 3753J Reversible Ratchet Llave de Carraca Reversible



\* Renewal Kits → 3753RK → P276



## D3753J Reversible Ratchet Llave de Carraca Reversible



\* Renewal Kits → 3753RK → P276



	D (mm)	T (mm)	H (mm)	L (mm)	(g)	(pce.)
3753N	30.5	26.4	15.7	200	320	1
3753P	30.5	26.4	15.7	200	286	1
3753J	30.5	26.4	15.7	200	260	1
D3753J	30.5	26.4	15.7	200	260	1

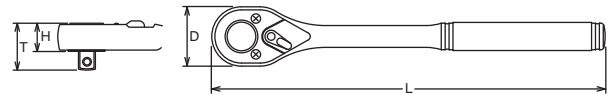

## 3753P-250 Reversible Ratchet Long Llave de Carraca Reversible Larga



\* Renewal Kits → 3753RK → P276



	D (mm)	T (mm)	H (mm)	L (mm)	(g)	(pce.)
3753P-250	30.5	26.4	15.7	250	335	1

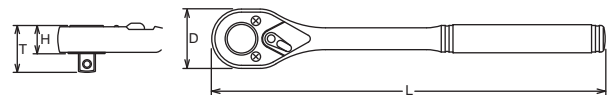



# Hand Sockets **3/8"**

HAND  
MANUALES

Z-SERIES

TITANIUM  
DE TITANIO

ACCESSORIES  
ACCESORIOS

SCREWDRIVERS  
DESTORNILLADORES

IMPACT  
DE IMPACTO

SLEEVE-DRIVE

INDUSTRIAL  
INDUSTRIALES

AUTOMOTIVE

CONSTRUCTION  
CONSTRUCCIÓN

RENEWAL KITS  
JUEGOS DE PIEZAS/REPLUSTO

## 3753SMB **Multi Purpose Ratchet with quick release button** Llave de Carraca de Aplicación General, reversible



\* Renewal Kits → **3753BRK** → [P276](#)



	D (mm)	T (mm)	H (mm)	L (mm)	(g)	(pcs.)
<b>3753SMB</b>	30.5	26.4	15.7	81	175	5

## 3753NB **Reversible Ratchet with quick release button** Llave de Carraca Reversible con botón de extracción rápida



\* Renewal Kits → **3753BRK** → [P276](#)

## 3753PB **Reversible Ratchet with quick release button** Llave de Carraca Reversible con botón de extracción rápida



\* Renewal Kits → **3753BRK** → [P276](#)

## 3753JB **Reversible Ratchet with quick release button** Llave de Carraca Reversible con botón de extracción rápida



\* Renewal Kits → **3753BRK** → [P276](#)

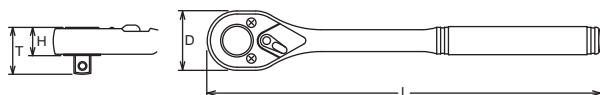

	D (mm)	T (mm)	H (mm)	L (mm)	(g)	(pce.)
<b>3753NB</b>	30.5	26.4	15.7	200	320	1
<b>3753PB</b>	30.5	26.4	15.7	200	286	1
<b>3753JB</b>	30.5	26.4	15.7	200	260	1

 Reversible Ratchet with quick release button has less strength compared with normal ratchet due to the technical design. Make sure to use the ratchet correctly.

# 3/8" Hand Sockets

HAND MANUALES  
Z-SERIES  
TITANIUM DE TITANIO  
ACCESSORIES ACCESORIOS  
SCREWDRIVERS DESTORNILLADORES  
IMPACT DE IMPACTO  
SLEEVE-DRIVE INDUSTRIAL  
AUTOMOTIVE  
CONSTRUCTION CONSTRUCCION  
RENEWAL KITS JUEGOS DE PIEZAS REPUESTO

**2774PS-3/8** Flexible Ratchet, Reversible  
Llave de Carraca Flexible, Reversible ⚠



\* Renewal Kits → 2749RK-3/8 → P276



**2774JS-3/8** Flexible Ratchet, Reversible  
Llave de Carraca Flexible, Reversible ⚠



\* Renewal Kits → 2749RK-3/8 → P276

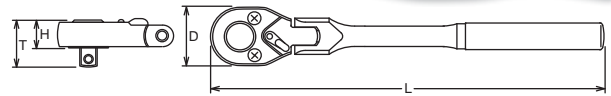

	D (mm)	T (mm)	H (mm)	L (mm)	(g)	(pcs.)
2774PS-3/8	25	21.9	11.2	120	133	5
2774JS-3/8	25	21.9	11.2	120	113	5

⚠ 2774-3/8 series have less strength compared with normal 3/8" ratchet due to the technical design. Make sure to use the ratchet correctly.



\* Renewal Kits → 3753RK → P276

**3774PS** Flexible Ratchet, Reversible  
Llave de Carraca Flexible, Reversible

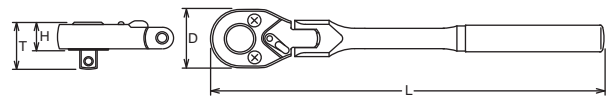

	D (mm)	T (mm)	H (mm)	L (mm)	(g)	(pcs.)
3774PS	30.5	26.4	15.7	175	250	2



\* Renewal Kits → 3753RK → P276

**3774N** Flexible Ratchet, Reversible  
Llave de Carraca Flexible, Reversible

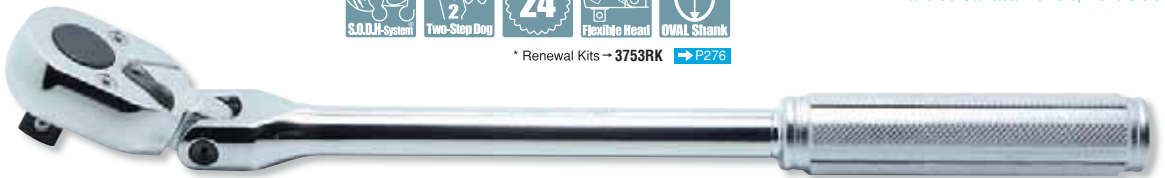

\* Renewal Kits → 3753RK → P276

**3774P** Flexible Ratchet, Reversible  
Llave de Carraca Flexible, Reversible

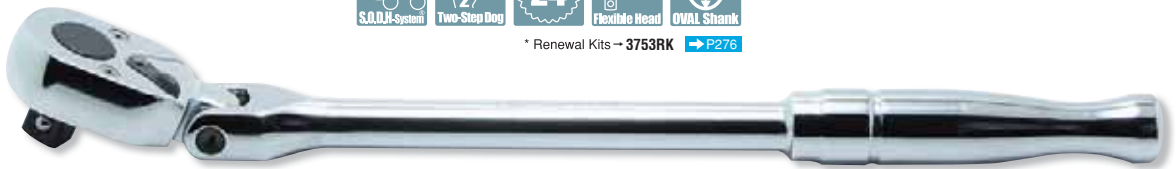

\* Renewal Kits → 3753RK → P276

**3774J** Flexible Ratchet, Reversible  
Llave de Carraca Flexible, Reversible

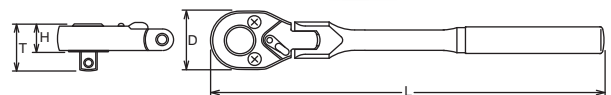

	D (mm)	T (mm)	H (mm)	L (mm)	(g)	(pcs.)
3774N	30.5	26.4	15.7	265	378	2
3774P	30.5	26.4	15.7	265	378	2
3774J	30.5	26.4	15.7	285	367	1

# Hand Sockets **3/8"**

HAND MANUALES  
Z-SERIES  
TITANIUM DE TITANIO  
ACCESSORIES ACCESORIOS  
SCREWDRIVERS DESTORNILLADORES  
IMPACT DE IMPACTO  
SLEEVE-DRIVE  
INDUSTRIAL INDUSTRIALES  
AUTOMOTIVE  
CONSTRUCTION CONSTRUCCION  
RENEWAL KITS JUEGOS DE PIEZAS REPLUSTO

## 3774P-SR Speeder Ratchet



\* Renewal Kits → 3753RK → P276

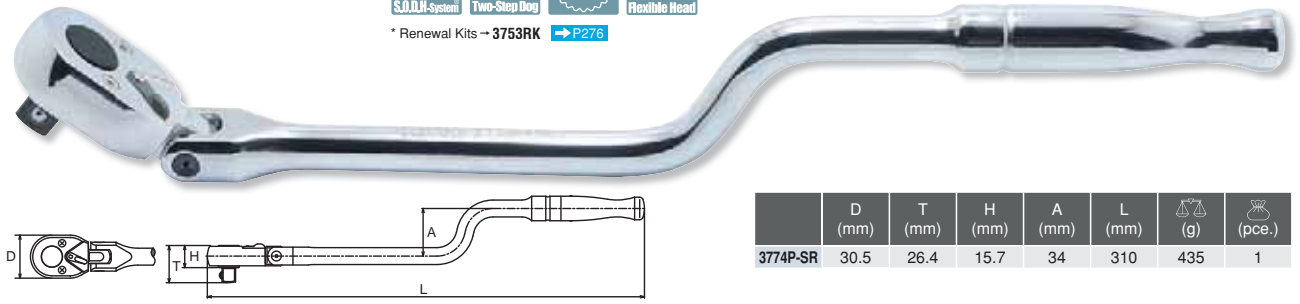

	D (mm)	T (mm)	H (mm)	A (mm)	L (mm)	(g)	(pcs.)
3774P-SR	30.5	26.4	15.7	34	310	435	1

## 3774NB Flexible Ratchet, reversible with quick release button

Llave de Carraca Flexible, reversible con botón de extracción rápida



\* Renewal Kits → 3753BRK → P276



## 3774PB Flexible Ratchet, reversible with quick release button

Llave de Carraca Flexible, reversible con botón de extracción rápida



\* Renewal Kits → 3753BRK → P276



## 3774JB Flexible Ratchet, reversible with quick release button

Llave de Carraca Flexible, reversible con botón de extracción rápida



\* Renewal Kits → 3753BRK → P276

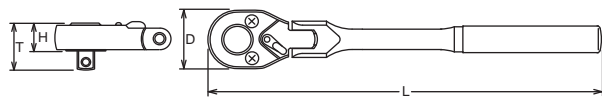

	D (mm)	T (mm)	H (mm)	L (mm)	(g)	(pcs.)
3774NB	30.5	26.4	15.7	265	378	2
3774PB	30.5	26.4	15.7	265	373	2
3774JB	30.5	26.4	15.7	285	367	1

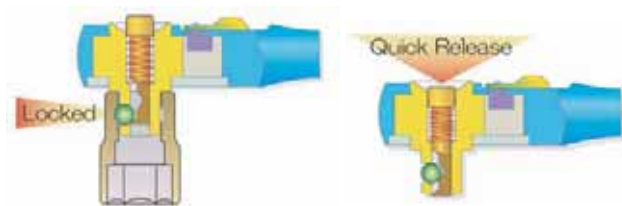

**Reversible Ratchet with Quick Release Button :**  
Sockets and accessories are safely locked.  
By pushing the button the sockets or extension bars are released from the ratchet.

**Llave de Carraca Reversible con Botón de Extracción Rápida :** Los vasos y accesorios se bloquean en posición. Los vasos o las alargaderas se extraen de la llave apretando el botón.

Reversible Ratchet with quick release button has less strength compared with normal ratchet due to the technical design. Make sure to use the ratchet correctly.

# 3/8" Hand Sockets



\* Renewal Kits → 3753BK → P276

**3774NL** Flex-Head Ratchet with Head Lock Button  
Llave de Carraca Flexible con Botón de Bloqueo de la Cabeza ⚠



\* Renewal Kits → 3753BK → P276

**3774PL** Flex-Head Ratchet with Head Lock Button  
Llave de Carraca Flexible con Botón de Bloqueo de la Cabeza ⚠



\* Renewal Kits → 3753BK → P276

**3774JL** Flex-Head Ratchet with Head Lock Button  
Llave de Carraca Flexible con Botón de Bloqueo de la Cabeza ⚠



\* Renewal Kits → 3753BK → P276

**3774JBL** ⚠  
Flex-Head Ratchet with Head Lock Button and Quick Release Button  
Llave de Carraca Flexible con Botón de Bloqueo de la Cabeza y Botón de Extracción Rápida



	D (mm)	T (mm)	H (mm)	L (mm)	(g)	(pcs.)
3774NL	30.5	26.4	15.7	265	378	2
3774PL	30.5	26.4	15.7	265	378	2
3774JL	30.5	26.4	15.7	285	367	1
3774JBL	30.5	26.4	15.7	285	367	1

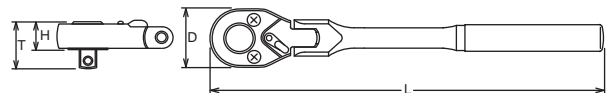

⚠ Reversible Ratchet with quick release button has less strength compared with normal ratchet due to the technical design. Make sure to use the ratchet correctly.

HAND MANUALES  
Z-SERIES  
TITANIUM DE TITANIO  
ACCESSORIES ACCESORIOS  
SCREWDRIVERS DESTORNILLADORES  
IMPACT DE IMPACTO  
SLEEVE-DRIVE INDUSTRIAL INDUSTRIALES  
AUTOMOTIVE  
CONSTRUCTION CONSTRUCCION  
RENEWAL KITS JUEGOS DE PIEZAS REPUESTO



# Hand Sockets 3/8"

HAND MANUALES  
Z-SERIES  
TITANIUM DE TITANIO  
ACCESSORIES ACCESORIOS  
SCREWDRIVERS DESTORNILLADORES  
IMPACT DE IMPACTO  
SLEEVE-DRIVE  
INDUSTRIAL INDUSTRIALES  
AUTOMOTIVE  
CONSTRUCTION CONSTRUCCION  
RENEWAL KITS JUEGOS DE PIEZAS REPLETO

**3755** Ratchet Adaptor  
Adaptador de carraca



**45**

\* Renewal Kits → **3755RK** → [P278](#)

	D (mm)	L (mm)	(g)	(pcs.)
<b>3755</b>	30.5	55	146	5

**3756** Quick Spinner  
Disco de Giro Rápido



	D (mm)	L (mm)	(g)	(pcs.)
<b>3756</b>	30.5	25.5	47	10

**3757** Ratchet Wheel  
Rueda de carraca



**45**  
L/R Marking

\* Renewal Kits → **3752RK** → [P276](#)

	D (mm)	L (mm)	(g)	(pcs.)
<b>3757</b>	50	35	155	5

**3762** Flexible Extension Bar  
Alargadera Flexible

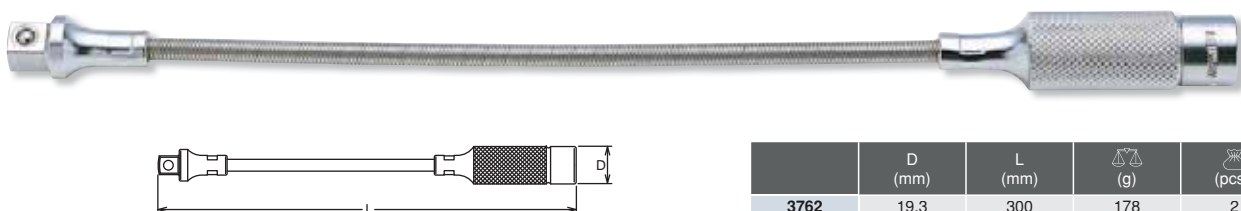

	D (mm)	L (mm)	(g)	(pcs.)
<b>3762</b>	19.3	300	178	2

3760	D (mm)	L (mm)	(g)	(pcs.)
32	18	32	27	10
50	18	50	47	10
75	18	75	68	10
125	18	125	106	10
150	18	150	125	10
250	18	250	196	5
300	18	300	291	2
400	18	400	365	1
500	18	500	490	1
600	18	600	538	1
900	18	900	805	1
1000	18	1000	968	1

## 3760-32 · -50 · -75 · -125 · -150 · -250 · -300 · -400 · -500 · -600 · -900 · -1000

Extension Bars  
Alargaderas

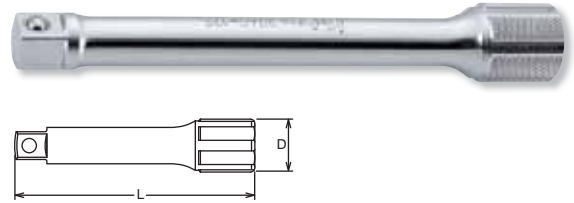

PK3760/6	6 Pieces Set/△△=670g
PLASTIC TRAY	
Extension Bars	
3760 Extension Bars 32, 50, 75, 125, 150, 250	

## PK3760/6 Set Juego



3763	D (mm)	L (mm)	(g)	(pcs.)
32	18	32	26	10
50	18	50	42	10
75	18	75	57	10
125	18	125	80	10
150	18	150	98	10
250	18	250	144	5
300	18	300	170	2

## 3763-32 · -50 · -75 · -125 · -150 · -250 · -300

Wobble-Fix Extension Bars  
Alargaderas Articuladas-Fijas ⚠

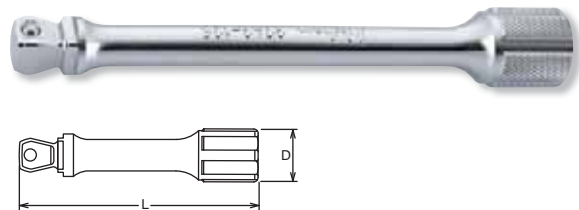

PK3763/6	6 Pieces Set/△△=560g
PLASTIC TRAY	
Extension Bars	
3763 Wobble-Fix Extension Bars 32, 50, 75, 125, 150, 250	

## PK3763/6 Set Juego



**Wobble-Fix Extension Bar**  
Two way usage : one for as a flexible extension bar to provide at 15° angle operation, the other for use as a normal extension bar. This usage is Patent.

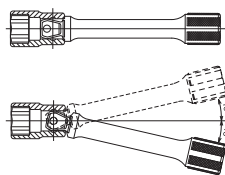

**Alargadera Articulada-Fija**  
Dos formas de utilización : Una como alargadera flexible para poder trabajar con un ángulo de 15° y otra para utilizarse como alargadera normal. Esta aplicación está patentada.

⚠ The Wobble-Fix Extension Bar has less strength than normal extension bar due to it's specific design with a reduced square drive. Make sure to use it correctly.

# Hand Sockets **3/8"**

HAND  
MANUALES

Z-SERIES

TITANIUM  
DE TITANIO

ACCESSORIES  
ACCESORIOS

SCREWDRIVERS  
DESTORNILLADORES

IMPACT  
DE IMPACTO

SLEEVE-DRIVE

INDUSTRIAL  
INDUSTRIALES

AUTOMOTIVE

CONSTRUCTION  
CONSTRUCCION

RENEWAL KITS  
JUEGOS DE PIEZAS REPLÉSTO

**3768N-175** Hinge Handle  
Mango Articulado



\* Renewal Kits → **3768RK** → [P278](#)



**3768N-250** Hinge Handle  
Mango Articulado



\* Renewal Kits → **3768RK** → [P278](#)



**3768P-250** Hinge Handle  
Mango Articulado



\* Renewal Kits → **3768RK** → [P278](#)



**3768J-250** Hinge Handle  
Mango Articulado



\* Renewal Kits → **3768RK** → [P278](#)

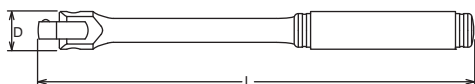

	D (mm)	L (mm)	(g)	(pcs.)
<b>3768N-175</b>	20.5	175	255	5
<b>3768N-250</b>	20.5	250	290	5
<b>3768P-250</b>	20.5	250	275	5
<b>3768J-250</b>	20.5	250	248	2

**3768N-300** Hinge Handle  
Mango Articulado



\* Renewal Kits → **3768RK** → [P278](#)



**3768P-380** Hinge Handle  
Mango Articulado

\* Renewal Kits → **3768RK** → [P278](#)

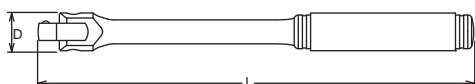

	D (mm)	L (mm)	(g)	(pcs.)
<b>3768N-300</b>	20.5	300	320	2
<b>3768P-380</b>	20.5	380	435	2

3768-300, -380 have longer handle than standard, and can be loaded to excessive torque value. In the interest of your own safety always apply load evenly and progressively to avoid breakage and possible injury.

# 3/8" Hand Sockets

3769N	(mm)	L (mm)	(g)	(pcs.)
160	50	160	96	2
230	120	230	126	2

**⚠** Plastic or rubber handles are not intended to act as insulation.  
Los mangos de plástico o de goma no están previstos para aislamiento.

## 3769N-160 • -230 Spin Type Handle Mango Tipo Destornillador **⚠**

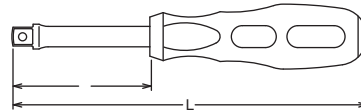

3769NWF	(mm)	L (mm)	(g)	(pcs.)
160	50	160	96	2
230	120	230	126	2

**⚠** Plastic or rubber handles are not intended to act as insulation.  
Los mangos de plástico o de goma no están previstos para aislamiento.

## 3769NWF-160 • -230 Spin Type Handle Wobble-Fix Mango Tipo Destornillador Articulado-Fijos **⚠**

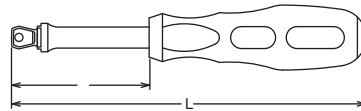

### Wobble-Fix Extension Bar

Two way usage : one for as a flexible extension bar to provide at 15° angle operation, the other for use as a normal extension bar. This usage is Patent.

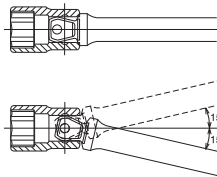

### Alargadera Articulada-Fija

Dos formas de utilización : Una como alargadera flexible para poder trabajar con un ángulo de 15° y otra para utilizarse como alargadera normal. Esta aplicación está patentada.

3769H	L (mm)	(g)	(pcs.)
3769H	170	210	2

## 3769H Folding Socket Driver Llave de Vaso Plegable

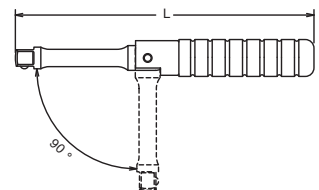
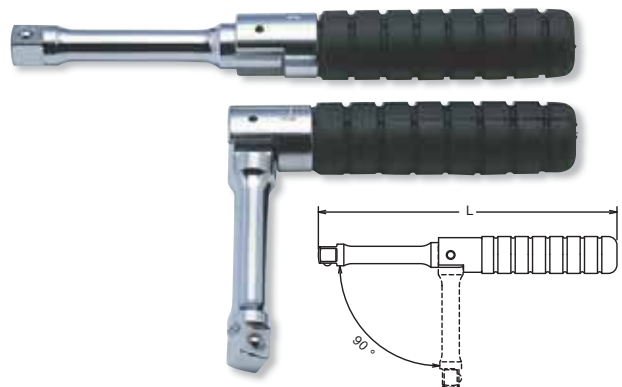

## 3770 Universal Joint Articulación Universal

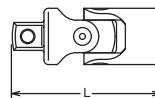

## 3771 Universal Joint Articulación Universal

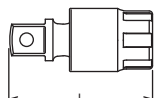

	L (mm)	(g)	(pcs.)
3770	50	66	10
3771	43	46	10

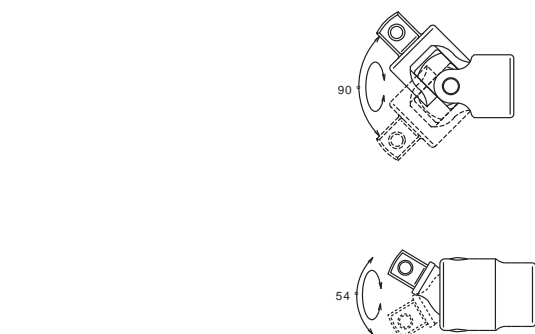

HAND MANUALES  
Z-SERIES  
TITANIUM DE TITANIO  
ACCESSORIES ACCESORIOS  
SCREWDRIVERS DESTORNILLADORES  
IMPACT DE IMPACTO  
SLEEVE-DRIVE INDUSTRIAL INDUSTRIALES  
AUTOMOTIVE  
CONSTRUCTION CONSTRUCCION  
RENEWAL KITS JUEGOS DE PIEZAS REPUESTO



# Hand Sockets **3/8"**

HAND MANUALES  
Z-SERIES  
TITANIUM DE TITANIO  
ACCESSORIES ACCESORIOS  
SCREWDRIVERS DESTORNILLADORES  
IMPACT DE IMPACTO  
SLEEVE-DRIVE  
INDUSTRIAL INDUSTRIALES  
AUTOMOTIVE  
CONSTRUCTION CONSTRUCCION  
RENEWAL KITS JUEGOS DE PIEZAS REPLÉSTO

**3780** Speed Handle  
Manivela Rápida

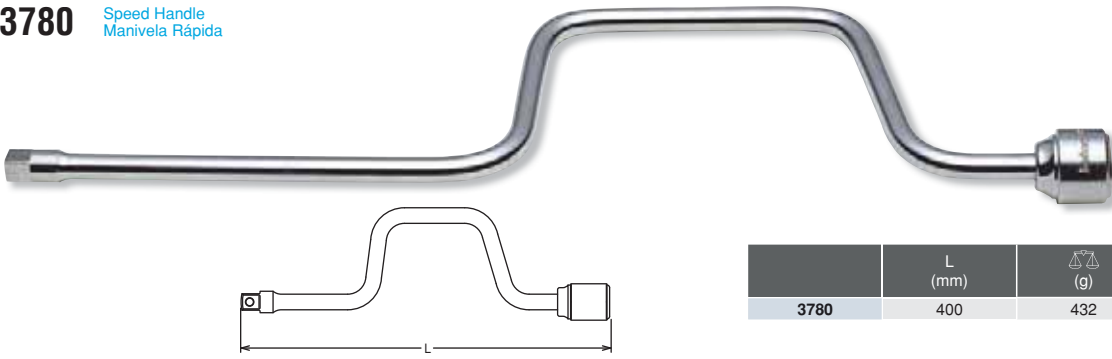

	L (mm)	(g)	(pcs.)
3780	400	432	1

**3785** T-Handle  
Mango Corredizo



Innovative Oval shaped bar provides higher durability and stops the sliding square part turning around the bar.

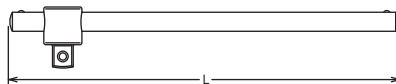

	L (mm)	(g)	(pcs.)
3785	200	157	5

**3322A** Adaptor Adaptador Warranty 86Nm Garantía 86Nm ⚠

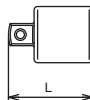

**3344A** Adaptor Adaptador

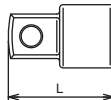

	□ (sq)	□ (sq)	L (mm)	(g)	(pcs.)
3322A	3/8"	1/4"	24	18	10
3344A	3/8"	1/2"	30	35	10

⚠ Adapting down from bigger square drive to smaller square drive may lead to excessive torque and possibly cause breakage.

La adaptación de mayor a menor de un cuadrado conductor puede conducir a un par excesivo que puede causar roturas.









**PK2346/6** Set Juego



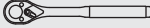









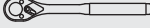
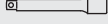
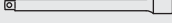
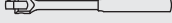

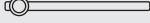





- 2233A (1/4") X 3/8"
- 3322A (3/8") X 1/4" Warranty/Garantía 86Nm
- 3344A (3/8") X 1/2"
- 4433A (1/2") X 3/8" Warranty/Garantía 290Nm
- 4466A (1/2") X 3/4"
- 6644A (3/4") X 1/2" Warranty/Garantía 668Nm



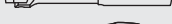

PK2346/6 6 Pieces Set/△=460g  
PLASTIC TRAY





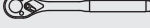
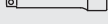
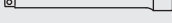
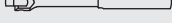

Adaptors					
1/4" □	3/8" □	2233A	3/8" □	1/4" □	3322A
3/8" □	1/2" □	3344A	1/2" □	3/8" □	4433A-35
1/2" □	3/4" □	4466A	3/4" □	1/2" □	6644A



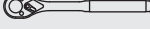
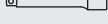

<b>3200M</b> 18 Pieces Set/⚖️=2,250g	
METAL CASE:W415xH120xT50mm	
Sockets	Accessories
<p> <b>3400M</b> 6-pt. Sockets 6, 8, 9, 10, 11, 12</p> <p> <b>3405M</b> 12-pt. Sockets 13, 14, 17, 18, 19, 21</p>	<p> <b>3753N</b></p> <p> <b>3760-125</b></p> <p> <b>3760-250</b></p> <p> <b>3768N-250</b></p> <p> <b>3769N-160</b></p> <p> <b>3785</b></p>

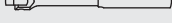
<b>3200A</b> 18 Pieces Set/⚖️=2,250g	
METAL CASE:W415xH120xT50mm	
Sockets	Accessories
<p> <b>3400A</b> 6-pt. Sockets 1/4, 5/16, 3/8, 7/16</p> <p> <b>3405A</b> 12-pt. Sockets 1/2, 9/16, 19/32, 5/8, 11/16, 3/4, 13/16, 7/8</p>	<p> <b>3753N</b></p> <p> <b>3760-125</b></p> <p> <b>3760-250</b></p> <p> <b>3768N-250</b></p> <p> <b>3769N-160</b></p> <p> <b>3785</b></p>

<b>3201AMW</b> 42 Pieces Set/⚖️=4,700g	
METAL CASE:W445xH190xT50mm	
Sockets	Accessories
<p> <b>3405M</b> 12-pt. Sockets 9, 10, 11, 12, 13, 14, 15, 16, 17, 18, 19, 20, 21, 22</p> <p> <b>3405A</b> 12-pt. Sockets 5/16, 3/8, 7/16, 1/2, 9/16, 5/8, 11/16, 3/4, 25/32, 13/16, 7/8</p> <p> <b>3405W</b> 12-pt. Sockets 1/8, 3/16, 1/4, 5/16, 3/8, 7/16, 1/2</p>	<p> <b>3753N</b></p> <p> <b>3760-75</b></p> <p> <b>3760-125</b></p> <p> <b>3760-250</b></p> <p> <b>3768N-250</b></p> <p> <b>3769N-160</b></p> <p> <b>3770</b></p> <p> <b>3780</b></p> <p> <b>3785</b></p> <p> <b>3344A</b></p>

<b>3206M</b> 21 Pieces Set/⚖️=3,100g	
METAL CASE:W395xH90xT50mm	
Sockets	Accessories
<p> <b>3400M</b> 6-pt. Sockets 6, 7, 8, 9, 10, 11, 12</p> <p> <b>3405M</b> 12-pt. Sockets 13, 14, 15, 16, 17, 18, 19, 21, 22</p>	<p> <b>3753N</b></p> <p> <b>3760-125</b></p> <p> <b>3760-250</b></p> <p> <b>3768N-250</b></p> <p> <b>3785</b></p>

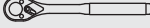
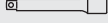
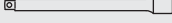
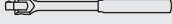
<b>3206A</b> 17 Pieces Set/⚖️=2,000g	
METAL CASE:W395xH90xT50mm	
Sockets	Accessories
<p> <b>3400A</b> 6-pt. Sockets 1/4, 5/16, 11/32, 3/8, 7/16</p> <p> <b>3405A</b> 12-pt. Sockets 1/2, 9/16, 5/8, 11/16, 3/4, 13/16, 7/8</p>	<p> <b>3753N</b></p> <p> <b>3760-125</b></p> <p> <b>3760-250</b></p> <p> <b>3768N-250</b></p> <p> <b>3785</b></p>

<b>3206AM</b> 27 Pieces Set/⚖️=3,500g	
METAL CASE:W445xH190xT50mm	
Sockets	Accessories
<p> <b>3405M</b> 12-pt. Sockets 7, 8, 10, 11, 12, 13, 14, 15, 16, 17, 19, 22</p> <p> <b>3405A</b> 12-pt. Sockets 3/8, 7/16, 1/2, 9/16, 5/8, 11/16, 3/4, 13/16, 7/8</p> <p> <b>3300C</b> Spark Plug Socket 20.8</p>	<p> <b>3753N</b></p> <p> <b>3760-125</b></p> <p> <b>3760-250</b></p> <p> <b>3768N-250</b></p> <p> <b>3770</b></p>

## 3200M • 3200A Socket Sets Juegos de Vasos



## 3201AMW Socket Set Juego de Vasos



## 3206M Socket Set Juego de Vasos



## 3206A Socket Set Juego de Vasos



## 3206AM Socket Set Juego de Vasos



# Hand Sockets **3/8"**

HAND  
MANUALES

Z-SERIES

TITANIUM  
DE TITANIO

ACCESSORIES  
ACCESORIOS

SCREWDRIVERS  
DESTORNILLADORES

IMPACT  
DE IMPACTO

SLEEVE-DRIVE

INDUSTRIAL  
INDUSTRIALES

AUTOMOTIVE

CONSTRUCTION  
CONSTRUCCION

RENEWAL KITS  
JUEGOS DE PIEZAS REPLETO

## 3210M Socket Set Juego de Vasos



## 3215M • 3215A Socket Sets Juegos de Vasos



## 3217M Socket Set Juego de Vasos



## 3220M Socket Set Juego de Vasos



## 3221M Socket Set Juego de Vasos



## 3244 Socket Set Juego de Vasos



3210M 22 Pieces Set/△=2,900g

METAL CASE:W395xH90xT50mm

Sockets	Accessories
<b>3400M</b> 6-pt. Sockets 6, 7, 8, 9, 10, 11, 12	<b>3753N</b>
<b>3405M</b> 12-pt. Sockets 13, 14, 15, 16, 17, 18, 19, 21, 22	<b>3760-125</b>
	<b>3760-250</b>
	<b>3768N-250</b>
	<b>3770</b>
	<b>3785</b>

3215M 7 Pieces Set/△=430g

PLASTIC BAG

Sockets
<b>3305M</b> 12-pt. Deep Sockets 8, 10, 11, 12, 13, 14, 17

3215A 7 Pieces Set/△=430g

PLASTIC BAG

Sockets
<b>3305A</b> 12-pt. Deep Sockets 5/16, 3/8, 7/16, 1/2, 9/16, 5/8, 11/16

3217M 14 Pieces Set/△=850g

METAL CASE:W163xH52xT33mm

Sockets
<b>3405M</b> 12-pt. Sockets 9, 10, 11, 12, 13, 14, 15, 16, 17, 18, 19, 20, 21, 22

3220M 14 Pieces Set/△=2,270g

METAL CASE:W415xH120xT50mm

Sockets	Accessories
<b>3405M</b> 12-pt. Sockets 8, 9, 10, 11, 12, 13, 14, 17, 19, 21, 22	<b>3753N</b>
	<b>3760-125</b>
	<b>3768N-250</b>

3221M 18 Pieces Set/△=2,300g

METAL CASE:W395xH90xT50mm

Sockets	Accessories
<b>3405M</b> 12-pt. Sockets 6, 8, 9, 10, 11, 12, 13, 14, 17, 19, 21, 22	<b>3753N</b>
	<b>3760-125</b>
	<b>3760-250</b>
	<b>3768N-250</b>
	<b>3769N-160</b>
	<b>3785</b>

3244 12 Pieces Set/△=1,110g

METAL CASE:W240xH100xT32mm

Sockets	Accessories
<b>3025.50</b> TORX® Bit Sockets T20, T25, T27, T30, T40, T45, T50	<b>3753N</b>
<b>3425</b> TORX® Sockets E8, E10, E12	<b>3760-75</b>

3240M-00	3400M 67 Pieces Set/△=2,800g	
3240M-05	3405M 67 Pieces Set/△=2,800g	
DISPLAY STAND:W410xH160xT500mm		
Sockets		
6mm:4pcs	12mm:4pcs	18mm:4pcs
7mm:4pcs	13mm:4pcs	19mm:3pcs
8mm:4pcs	14mm:4pcs	20mm:3pcs
9mm:4pcs	15mm:4pcs	21mm:3pcs
10mm:4pcs	16mm:4pcs	22mm:3pcs
11mm:4pcs	17mm:4pcs	23mm:3pcs

**3240M-00**  Display Stands Expositores  
**3240M-05** 



S3240M-00	3400M 177 Pieces Set/△=10,300g	
S3240M-05	3405M 177 Pieces Set/△=10,300g	
DISPLAY STAND:W510xH150xT230mm		
Sockets		
6mm:12pcs	12mm:12pcs	18mm:8pcs
7mm:12pcs	13mm:11pcs	19mm:8pcs
8mm:12pcs	14mm:11pcs	20mm:7pcs
9mm:12pcs	15mm:10pcs	21mm:7pcs
10mm:12pcs	16mm: 9pcs	22mm:7pcs
11mm:12pcs	17mm: 9pcs	23mm:6pcs





**S3240M-00 · S3240A-00**  Display Stands Expositores  
**S3240M-05 · S3240A-05** 



S3240A-00	3400A 126 Pieces Set/△=8,500g	
S3240A-05	3405A 126 Pieces Set/△=8,500g	
DISPLAY STAND:W510xH150xT230mm		
Sockets		
1/4" :12pcs	9/16":10pcs	25/32":7pcs
5/16":12pcs	19/32":10pcs	13/16":7pcs
3/8" :12pcs	5/8" : 9pcs	7/8" :7pcs
7/16":12pcs	11/16": 9pcs	
1/2" :11pcs	3/4" : 8pcs	

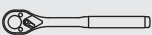
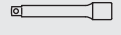



**3250M** Socket Set Juego de Vasos



3250M	17 Pieces Set/△=2,200g
METAL CASE:W415xH120xT50mm	
Sockets	Accessories
 3400M 6-pt. Sockets 7, 8, 10, 11, 12, 13, 14, 15, 16, 17, 18, 19	 3753N
	 3760-125
	 3760-250
	 3770
	 3785

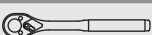

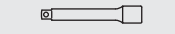

**3252M** Socket Set Juego de Vasos



3252M	15 Pieces Set/△=1,530g
METAL CASE:W310xH90xT48mm	
Sockets	Accessories
 3400M 6-pt. Sockets 5.5, 7, 8, 10, 11, 12	 3753P
 3405M 12-pt. Sockets 13, 14, 17, 19, 22	 3760-75
	 3760-125
	 3770

**P3262M-6P** Socket Set Juego de Vasos



P3262M-6P	11 Pieces Set/△=1,140g
PLASTIC CASE:W245xH120xT45mm	
Sockets	Accessories
 3400M 6-pt. Sockets 8, 10, 12, 13, 14, 17, 19	 3753N
	 3760-75
	 3760-125
	 3770



# Hand Sockets **3/8"**

HAND  
MANUALES

Z-SERIES

TITANIUM  
DE TITANIO

ACCESSORIES  
ACCESORIOS

SCREWDRIVERS  
DESTORNILLADORES

IMPACT  
DE IMPACTO

SLEEVE-DRIVE

INDUSTRIAL  
INDUSTRIALES

AUTOMOTIVE

CONSTRUCTION  
CONSTRUCCION

RENEWAL KITS  
JUEGOS DE PIEZAS REPLÉSTO

## 3275 Socket Set Juego de Vasos



3275 24 Pieces Set/△=3,150g	
METAL CASE:W400xH147xT50mm	
Sockets	Accessories
<ul style="list-style-type: none"> <li>3400M 6-pt. Sockets 6, 7, 8, 9, 10, 11, 12</li> <li>3405M 12-pt. Sockets 13, 14, 15, 16, 17, 18, 19, 21, 22</li> <li>3300C Spark Plug Sockets 16, 20.8</li> </ul>	<ul style="list-style-type: none"> <li>3753N</li> <li>3760-125</li> <li>3760-250</li> <li>3768N-250</li> <li>3770</li> <li>3756</li> </ul>

## 3276 Bit Socket Set Juego de Vasos con Punta



3276 20 Pieces Set/△=3,370g	
METAL CASE:W310xH150xT50mm	
Sockets	Accessories
<ul style="list-style-type: none"> <li>3000 Bit Sockets 2, 3</li> <li>3005 Bit Sockets 5, 8</li> <li>3010M.62 Hex Bit Sockets 5, 6, 7, 8, 10</li> <li>3025.50 TORX® Bit Sockets T10, T15, T20, T25, T27, T30, T40, T45, T50</li> </ul>	<ul style="list-style-type: none"> <li>3753N</li> <li>3763-125</li> </ul>

## 3277 Socket Set Juego de Vasos



3277 29 Pieces Set/△=3,240g	
METAL CASE:W370xH150xT50mm	
Sockets	Accessories
<ul style="list-style-type: none"> <li>3400M 6-pt. Sockets 8, 9, 10, 11, 12</li> <li>3405M 12-pt. Sockets 13, 14, 15, 16, 17, 18, 19, 21</li> <li>3300M 6-pt. Deep Sockets 8, 9, 10, 11, 12</li> <li>3305M 12-pt. Deep Sockets 13, 14, 15, 16, 17, 18, 19, 21</li> </ul>	<ul style="list-style-type: none"> <li>3753N</li> <li>3760-125</li> <li>3768N-250</li> </ul>

## 3279AM Socket Set Juego de Vasos





3279AM 35 Pieces Set/△=4,200g	
METAL CASE:W445xH190xT50mm	
Sockets	Accessories
<ul style="list-style-type: none"> <li>3405M 12-pt. Sockets 9, 10, 11, 12, 13, 14, 15, 16, 17, 18, 19, 20, 21, 22</li> <li>3405A 12-pt. Sockets 5/16, 3/8, 7/16, 1/2, 9/16, 5/8, 11/16, 3/4, 25/32, 13/16, 7/8</li> <li>3300S Spark Plug Sockets 16, 20.8</li> </ul>	<ul style="list-style-type: none"> <li>3753N</li> <li>3760-75</li> <li>3760-125</li> <li>3760-250</li> <li>3768N-250</li> <li>3769N-160</li> <li>3770</li> <li>3785</li> </ul>

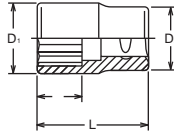

## 4400M • 4400A 6-Point Sockets Vasos Hexagonales



## 4405M • 4405A 12-Point Sockets Vasos Bihexagonales





	4400M 4405M (mm)	D <sub>1</sub> (mm)	D <sub>2</sub> (mm)	(mm)	L (mm)	 (g)	 (pcs.)
New	6	10.3	21	6	36	42	10
New	7	11.5	21	7	36	43	10
	8	13.2	21	8	36	44	10
	9	13.8	21	8.5	37	44	10
	10	15.3	21	9	37	45	10
	11	16.5	21	9.5	37	46	10
	12	17.8	21	10	37	47	10
	13	19	22	10.5	37	53	10
	14	20.3	22	11	37	56	10
	15	21.5	22	11.5	37	57	10
	16	22.8	22	12	37	62	10
	17	24	23	12.5	37	69	10
	18	25	24	13	37	74	10
	19	26.5	25	14	38	89	10
	20	27.8	26	15	38	92	10
	21	29	27	15.5	38	102	10
	22	30	28	16	40	113	10
	23	31.5	29	16.5	40	128	10
	24	32.8	30	17	42	140	5
	25	34	31	18	42	164	5
	26	35	32	19	42	165	5
	27	36.5	33	19.5	43	182	5
	28	37.8	34	20	43	198	5
	29	39	35	20.5	43	205	5
	30	40	36	22	46	222	5
	31	41.5	37	22.5	46	246	5
	32	42.8	38	23	46	261	5
	33	44.2	39	24	47	275	5
	34	45.2	40	24	47	315	5
	35	46.2	40	24	47	317	5
	36	47.2	41	24	47	336	5
New	37	48.3	42	24	47	360	5
New	38	49.2	43	24	47	380	5
New	41	53.1	45	29	57	471	5
New	46	59.1	48	32	60	567	2

	4400A 4405A (inch)	D <sub>1</sub> (mm)	D <sub>2</sub> (mm)	(mm)	L (mm)	 (g)	 (pcs.)
	5/16	13.2	21	8	36	44	10
	3/8	14.6	21	9	37	45	10
	7/16	16.5	21	9.5	37	46	10
	1/2	19	22	10.5	37	53	10
	9/16	20.3	22	11	37	56	10
	19/32	21.5	22	11.5	37	57	10
	5/8	22.8	22	12	37	62	10
	21/32	24	23	12.5	37	69	10
	11/16	25	24	13	37	74	10
	3/4	26.5	25	14	38	89	10
	25/32	27.8	26	15	38	92	10
	13/16	29	27	15.5	38	102	10
	7/8	30	28	16	40	113	10
	15/16	32.8	30	17	42	140	5
	1	35	32	19	42	165	5
	1. 1/16	36.5	33	19.5	43	180	5
	1. 1/8	39	35	20.5	43	210	5
	1. 3/16	40	36	22	46	222	5
	1. 1/4	42.8	38	23	46	261	5
	1. 5/16	44.2	39	24	47	275	5
	1. 3/8	46.2	40	24	47	317	5
	1. 7/16	47.2	41	24	47	336	5
	1. 1/2	49.2	43	24	47	380	5

RS4400M/10	10 Pieces Set/Rail 300mm	 (g)
10, 11, 12, 13, 14, 15, 17, 19, 21, 22		717

RS4405M/10	10 Pieces Set/Rail 300mm	 (g)
10, 11, 12, 13, 14, 15, 17, 19, 21, 22		717

RS4400A/10	10 Pieces Set/Rail 300mm	 (g)
3/8, 7/16, 1/2, 9/16, 5/8, 11/16, 3/4, 13/16, 7/8, 15/16		809

RS4405A/10	10 Pieces Set/Rail 300mm	 (g)
3/8, 7/16, 1/2, 9/16, 5/8, 11/16, 3/4, 13/16, 7/8, 15/16		809

**RS4400M/10**   Socket Set on Rail  
Juego de Vasos en Regleta

**RS4405M/10**  

**RS4400A/10**   Socket Set on Rail  
Juego de Vasos en Regleta

**RS4405A/10**  



HAND MANUALES  
Z-SERIES  
TITANIUM DE TITANIO  
ACCESSORIES ACCESORIOS  
SCREWDRIVERS DESTORNILLADORES  
IMPACT DE IMPACTO  
SLEEVE-DRIVE  
INDUSTRIAL INDUSTRIALES  
AUTOMOTIVE  
CONSTRUCTION CONSTRUCCION  
RENEWAL KITS JUEGOS DE PIEZAS REPUESTO

# Hand Sockets 1/2"

HAND MANUALES  
Z-SERIES  
TITANIUM DE TITANIO  
ACCESSORIES ACCESORIOS  
SCREWDRIVERS DESTORNILLADORES  
IMPACT DE IMPACTO  
SLEEVE-DRIVE  
INDUSTRIAL INDUSTRIALES  
AUTOMOTIVE  
CONSTRUCTION CONSTRUCCION  
RENEWAL KITS JUEGOS DE PIEZAS/REPLISTO

## 4410M Surface Drive Sockets Vasos Surface Drive (de Contacto Curvo)



## RS4410M/10 Socket Set on Rail Juego de Vasos en Regleta



## 4400W 6-point Whitworth Sockets Vasos Whitworth Hexagonales



## 4405W 12-point Whitworth Sockets Vasos Whitworth Bihexagonales



## RS4400W/8 Socket Set on Rail Juego de Vasos en Regleta

## RS4405W/8 Socket Set on Rail Juego de Vasos en Regleta



### BS W



BS W	BS	3/16BS	1/4BS	5/16BS	3/8BS	7/16BS	1/2BS	9/16BS	5/8BS	11/16BS	3/4BS	7/8BS
	W	1/8W	3/16W	1/4W	5/16W	3/8W	7/16W	1/2W	9/16W	5/8W	11/16W	3/4W
Across Flat	(ref. mm)	8.64	11.30	13.34	15.24	18.03	20.83	23.37	25.65	27.94	30.48	33.35

## 4425 TORX® Sockets Vasos TORX®



### TORX® (E)



E	E4	E5	E6	E7	E8	E10	E11	E12	E14	E16	E18	E20	E22	E24	E26	E28	
S	(ref. mm)	3.83	4.72	5.69	6.17	7.47	9.37	10.03	11.12	12.85	14.71	16.64	18.41	20.24	22.10	23.85	25.65

## RS4425/7 Socket Set on Rail Juego de Vasos en Regleta



4410M (mm)	D <sub>1</sub> (mm)	D <sub>2</sub> (mm)	(mm)	L (mm)	(g)	(pcs.)
8	13.2	21	8	36	44	10
9	13.8	21	8.5	37	44	10
10	15.3	21	9	37	45	10
11	16.5	21	9.5	37	46	10
12	17.8	21	10	37	47	10
13	19	22	10.5	37	53	10
14	20.3	22	11	37	56	10
15	21.5	22	11.5	37	52	10
16	22.8	22	12	37	62	10
17	24	23	12.5	37	69	10
18	25	24	13	37	74	10
19	26.5	25	14	38	89	10
20	27.8	26	15	38	92	10
21	29	27	15.5	38	102	10
22	30	28	16	40	113	10
23	31.5	29	16.5	40	128	10
24	32.8	30	17	42	140	5
25	34	31	18	42	164	5
26	35	32	19	42	165	5
27	36.5	33	19.5	43	196	5
28	37.8	34	20	43	198	5
29	39	35	20.5	43	190	5
30	40	36	22	46	222	5
31	41.5	37	22.5	46	257	5
32	42.8	38	23	46	250	5
34	45.2	40	24	47	314	5

RS4410M/10	10 Pieces Set/Rail 300mm	(g)
10, 11, 12, 13, 14, 15, 17, 19, 21, 22		717

4400W 4405W (W)	D <sub>1</sub> (mm)	D <sub>2</sub> (mm)	(mm)	L (mm)	(g)	(pcs.)
3/16	16.5	21	9.5	37	46	10
1/4	19	22	10.5	37	54	10
5/16	21.5	22	11.5	37	54	10
3/8	25	24	13	37	73	10
7/16	29	27	15.5	38	87	10
1/2	31.5	29	16.5	40	133	10
9/16	35	32	19	42	165	5
5/8	37.8	34	20	43	191	5
11/16	40	36	22	46	222	5
3/4	44.2	39	24	47	280	5

RS4400W/8	8 Pieces Set/Rail 250mm	(g)
3/16, 1/4, 5/16, 3/8, 7/16, 1/2, 9/16, 5/8		860

RS4405W/8	8 Pieces Set/Rail 250mm	(g)
3/16, 1/4, 5/16, 3/8, 7/16, 1/2, 9/16, 5/8		860

4425 (E)	D <sub>1</sub> (mm)	D <sub>2</sub> (mm)	(mm)	L (mm)	(g)	(pcs.)
E 8	10.7	21	7	36	41	10
E10	13.2	21	8.2	36	44	10
E11	13.8	21	8.7	37	45	10
E12	14.6	21	9.3	37	47	10
E14	16.5	21	10.6	37	48	10
E16	19	22	11.8	37	57	10
E18	20.3	22	13	37	57	10
E20	22.8	22	14.4	37	63	10
E22	25	24	15.5	37	78	10
E24	26.5	25	17	40	95	5

RS4425/7	7 Pieces Set/Rail 200mm	(g)
E10, E12, E14, E16, E18, E20, E24		428

	4425 (E)	D <sub>1</sub> (mm)	D <sub>2</sub> (mm)	(mm)	L (mm)	(g)	(pcs.)
New	<b>E10N</b>	13.2	21	8.2	36	47	10
New	<b>E12N</b>	14.6	21	9.3	37	48	10
New	<b>E14N</b>	16.5	21	10.6	37	50	10
New	<b>E16N</b>	19	22	11.8	37	60	10
New	<b>E18N</b>	20.3	22	13	37	60	10
	<b>E20N</b>	22.8	22	14.4	37	65	10

TORX Socket for Nut and low profile bolt  
Shallow Chamfer on Socket Opening



A : Flywheel bolt MR20 NISSAN: 4425-E20N  
B : Cam sprocket FA20 for TOYOTA/SUBARU: 4425-E14N  
C : Connecting rod bolt FA20 for TOYOTA/SUBARU: 4425-E14N

RS4425/6-N		6 Pieces Set/Rail 200mm	(g)
New	<b>E10N, E12N, E14N, E16N, E18N, E20N</b>		370

	4425 (EPL)	D <sub>1</sub> (mm)	D <sub>2</sub> (mm)	(mm)	L (mm)	(g)	(pcs.)
	<b>10EPL</b>	13.2	21	6.2	36	45	10
	<b>12EPL</b>	14.6	21	7.2	37	47	10
	<b>14EPL</b>	16.5	21	8.1	37	49	10
	<b>16EPL</b>	19	22	9.2	37	60	10
	<b>18EPL</b>	20.3	22	10.2	37	60	10
	<b>20EPL</b>	22.9	22	11.2	37	65	10

RS4425/6-EPL		6 Pieces Set/Rail 200mm	(g)
	<b>10EPL, 12EPL, 14EPL, 16EPL, 18EPL, 20EPL</b>		390

	4450M (mm)	D <sub>1</sub> (mm)	D <sub>2</sub> (mm)	(mm)	L (mm)	(g)	(pcs.)
	<b>10</b>	15.3	21	6	36	44	10
	<b>11</b>	16.5	21	6.5	36	46	10
	<b>12</b>	17.8	21	7	36	46	10
	<b>13</b>	19	22	8	36	57	10
	<b>14</b>	20.3	22	8.5	36	54	10
	<b>15</b>	21.5	22	9	36	52	10
	<b>16</b>	22.8	22	9	36	60	10
	<b>17</b>	24	23	9.5	36	68	10
	<b>18</b>	25	24	10.5	36	77	10
	<b>19</b>	26.5	25	11.5	36	85	10
	<b>21</b>	29	27	12	37	110	10
	<b>22</b>	30	28	12.5	37	105	10
	<b>24</b>	32.8	30	14.5	39	130	5
	<b>27</b>	36.5	33	16.5	40	139	5

RS4450M/10		10 Pieces Set/Rail 300mm	(g)
	<b>10, 11, 12, 13, 14, 15, 17, 19, 21, 22</b>		717

	4400LH (LH-S)	D <sub>1</sub> (mm)	D <sub>2</sub> (mm)	(mm)	L (mm)	(g)	(pcs.)
	<b>6S</b>	13.2	21	5.6	36	44	10
	<b>8S</b>	16.5	21	6.8	37	46	10
	<b>10S</b>	19	22	8	37	53	10
	<b>12S</b>	22.8	22	9.2	37	62	10
	<b>14S</b>	25	24	10.4	37	74	10
	<b>16S</b>	29	27	11.6	38	102	10

RS4400LH/6		6 Pieces Set/Rail 200mm	(g)
	<b>6S, 8S, 10S, 12S, 14S, 16S</b>		430

## 4425-N TORX® Sockets Vasos TORX®

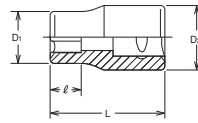

## RS4425/6-N Socket Set on Rail Juego de Vasos en Regleta



## 4425-EPL TORX PLUS® Sockets Vasos TORX PLUS®

**TORXplus**

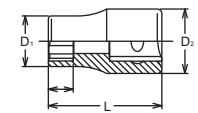

## RS4425/6-EPL Socket Set on Rail Juego de Vasos en Regleta



## 4450M Nut Grip Sockets Nut Grip® Vasos Sujeta-Tuercas Nut Grip®

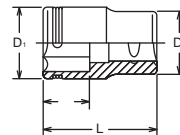

## RS4450M/10 Socket Set on Rail Juego de Vasos en Regleta



## 4400LH LHS Sockets Vasos LHS

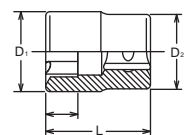

## RS4400LH/6 Socket Set on Rail Juego de Vasos en Regleta



HAND MANUALES  
Z-SERIES  
TITANIUM DE TITANIO  
ACCESSORIES ACCESORIOS  
SCREWDRIVERS DESTORNILLADORES  
IMPACT DE IMPACTO  
SLEEVE-DRIVE INDUSTRIAL  
AUTOMOTIVE  
CONSTRUCTION CONSTRUCCION  
RENEWAL KITS JUEGOS DE PIEZAS REPUESTO

# Hand Sockets 1/2"

HAND MANUALES  
Z-SERIES  
TITANIUM DE TITANIO  
ACCESSORIES ACCESORIOS  
SCREWDRIVERS DESTORNILLADORES  
IMPACT DE IMPACTO  
SLEEVE-DRIVE  
INDUSTRIAL INDUSTRIALES  
AUTOMOTIVE  
CONSTRUCTION CONSTRUCCION  
RENEWAL KITS JUEGOS DE PIEZAS REPLETO

## 4300M • 4300A 6-Point Deep Sockets Vasos Hexagonales Largos

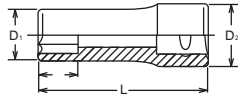

4300M 4305M (mm)	D <sub>1</sub> (mm)	D <sub>2</sub> (mm)	(mm)	L (mm)	(g)	(pcs.)
8	13.2	21	9	77	76	10
9	13.8	21	10	77	82	10
10	15.3	21	11	77	82	10
11	16.5	21	12	77	86	10
12	17.8	21	13	77	92	10
13	19	21.8	14	77	106	10
14	20.3	21.8	15	77	115	10
15	21.5	21.8	16	77	123	10
16	22.8	22	17	77	141	10
17	24	23	18	77	139	10
18	25	24	19	77	149	10
19	26.5	25	20	77	165	10
20	27.8	26	21	77	183	10
21	29	27	23	77	190	10
22	30	28	27	77	200	10
23	31.5	29	27	77	233	10
24	32.8	30	27	77	249	10
25	34	31	27	77	270	10
26	35	32	27	77	279	10
27	36.5	33	28	77	303	10
28	37.8	34	28	77	331	10
29	39	35	28	77	357	10
30	40	36	34	77	342	10
31	41.5	37	34	77	384	10
32	42.8	38	34	77	405	10
34	45.2	40	35	77	442	5
36	48	43	36	77	484	5
New 37	48.2	42	36	77	475	5
New 38	49	44	37	77	490	5

## 4305M • 4305A 12-Point Deep Sockets Vasos Bihexagonales Largos

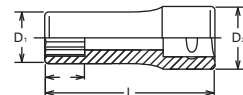

4300A 4305A (inch)	D <sub>1</sub> (mm)	D <sub>2</sub> (mm)	(mm)	L (mm)	(g)	(pcs.)
5/16	13.2	21	9	77	76	10
3/8	14.6	21	10	77	82	10
7/16	16.5	21	12	77	86	10
1/2	19	21.8	14	77	106	10
9/16	20.3	21.8	15	77	115	10
19/32	21.5	21.8	16	77	123	10
5/8	22.8	22	17	77	141	10
21/32	24	23	18	77	139	10
11/16	25	24	19	77	149	10
3/4	26.5	25	20	77	165	10
25/32	27.8	26	21	77	183	10
13/16	29	27	23	77	190	10
7/8	30	28	27	77	200	10
15/16	32.8	30	27	77	249	10
31/32	34	31	27	77	270	10
1	35	32	27	77	279	10
1. 1/16	36.5	33	28	77	303	10
1. 1/8	37.8	34	28	77	331	10
1. 3/16	40	36	34	77	342	10
1. 1/4	42.8	38	34	77	405	10
1. 3/8	46.2	40	35	77	422	5
1. 7/16	48	43	36	77	484	5
1. 1/2	49	44	38	77	523	5
1.13/16	59	48	38	77	791	5

## RS4300M/10 Socket Set on Rail Juego de Vasos en Regleta

## RS4300A/10 Socket Set on Rail Juego de Vasos en Regleta



RS4300M/10	10 Pieces Set/Rail 300mm	(g)
10, 11, 12, 13, 14, 15, 17, 19, 21, 22		1,415

RS4305M/10	10 Pieces Set/Rail 300mm	(g)
10, 11, 12, 13, 14, 15, 17, 19, 21, 22		1,415

RS4300A/10	10 Pieces Set/Rail 300mm	(g)
3/8, 7/16, 1/2, 9/16, 5/8, 11/16, 3/4, 13/16, 7/8, 15/16		1,600

RS4305A/10	10 Pieces Set/Rail 300mm	(g)
3/8, 7/16, 1/2, 9/16, 5/8, 11/16, 3/4, 13/16, 7/8, 15/16		1,600



# 1/2" Hand Sockets

4300M(L120) (mm)	D <sub>1</sub> (mm)	D <sub>2</sub> (mm)	(mm)	L (mm)	(g)	(pcs.)
8	13.2	21	9	120	120	5
10	15.3	21	11	120	138	5
12	17.8	21	13	120	157	5
14	20.3	21.8	15	120	193	5
16	22.8	22	17	120	210	5

4310M	D <sub>1</sub> (mm)	D <sub>2</sub> (mm)	(mm)	L (mm)	(g)	(pcs.)
8	13.2	21	9	77	79	10
9	13.8	21	10	77	82	10
10	15.3	21	11	77	82	10
11	16.5	21	12	77	86	10
12	17.8	21	13	77	92	10
13	19	21.8	14	77	106	10
14	20.3	21.8	15	77	115	10
15	21.5	21.8	16	77	123	10
16	22.8	22	17	77	141	10
17	24	23	18	77	139	10
18	25	24	19	77	149	10
19	26.5	25	20	77	165	10
20	27.8	26	21	77	183	10
21	29	27	23	77	190	10
22	30	28	27	77	200	10
23	31.5	29	27	77	233	10
24	32.8	30	27	77	249	10
25	34	31	27	77	270	10
26	35	32	27	77	279	10
27	36.5	33	28	77	303	10
28	37.8	34	28	77	334	10
29	39	35	28	77	357	10
30	40	36	34	77	342	10
31	41.5	37	34	77	384	10
32	42.8	38	34	77	405	10
34	45.2	40	35	77	442	5

RS4310M/10	10 Pieces Set/Rail 300mm	(g)
10, 11, 12, 13, 14, 15, 17, 19, 21, 22		1,415

4325 (E)	D <sub>1</sub> (mm)	D <sub>2</sub> (mm)	(mm)	L (mm)	(g)	(pcs.)
E 8	10.7	21	7	77	68	10
E10	13.2	21	8.2	77	99	10
E11	13.8	21	8.7	77	84	10
E12	14.6	21	9.3	77	99	10
E14	16.5	21	10.6	77	103	10
E16	19	21.8	11.8	77	107	10
E18	20.3	21.8	13	77	118	10
E20	22.8	22	14.4	77	141	10
E24	26.6	25	17	77	215	10

TORX®  
(E)



E	E4	E5	E6	E7	E8	E10	E11	E12	E14	E16	E18	E20	E22	E24	E26	E28
S (ref. mm)	3.83	4.72	5.69	6.17	7.47	9.37	10.03	11.12	12.85	14.71	16.64	18.41	20.24	22.10	23.85	25.65

RS4325/7	7 Pieces Set/Rail 200mm	(g)
E10, E12, E14, E16, E18, E20, E24		900

## 4300M (L120) 6-Point Extra Deep Sockets Vasos Hexagonales Extra Largos

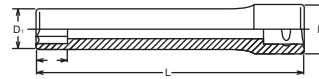

## 4310M Surface Drive Deep Sockets Vasos Surface Drive (de Contacto Curvo) Largos

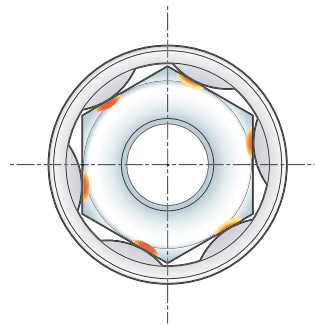
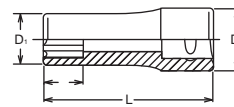

## RS4310M/10 Socket Set on Rail Juego de Vasos en Regleta



## 4325 TORX® Deep Sockets Vasos TORX® Largos

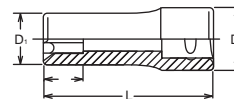

## RS4325/7 Socket Set on Rail Juego de Vasos en Regleta



# Hand Sockets 1/2"

HAND MANUALES  
Z-SERIES  
TITANIUM DE TITANIO  
ACCESSORIES ACCESORIOS  
SCREWDRIVERS DESTORNILLADORES  
IMPACT DE IMPACTO  
SLEEVE-DRIVE  
INDUSTRIAL INDUSTRIALES  
AUTOMOTIVE  
CONSTRUCTION CONSTRUCCION  
RENEWAL KITS JUEGOS DE PIEZAS REPLUSTO

## 4325 (L140) TORX® Extra Deep Sockets Vasos TORX® Extra Largos

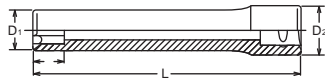

4325(L140) (E)	D <sub>1</sub> (mm)	D <sub>2</sub> (mm)	(mm)	L (mm)	(g)	(pcs.)
E 8	10.7	21	7	140	110	5
E10	13.2	21	8.2	140	140	5
E12	14.6	21	9.3	140	160	5
E14	16.5	21	10.6	140	180	5

## 4325 (L140)-2B TORX® Extra Deep Sockets, Nut Grip® Vasos TORX® Extra Largos, Nut Grip®

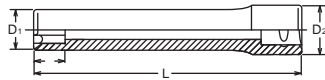

4325(L140) (E)	D <sub>1</sub> (mm)	D <sub>2</sub> (mm)	(mm)	L (mm)	(g)	(pcs.)
E 8(2B)	10.7	21	7	140	110	5
E10(2B)	13.2	21	8.2	140	140	5
E12(2B)	14.6	21	9.3	140	160	5
E14(2B)	16.5	21	10.6	140	180	5

### NUT GRIP®

Twin balls at the 6-point opening hold bolt-nut tightly for safe and reliable work.

Las dos bolas de la boca Hexagonal sujetan el perno-tuerca permitiendo un trabajo seguro y fiable.

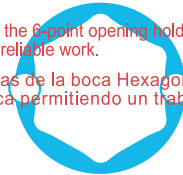

## 4440M • 4440A 6-point Universal Sockets Vasos Hexagonales con Articulación Universal

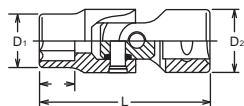

4440M (mm)	D <sub>1</sub> (mm)	D <sub>2</sub> (mm)	(mm)	L (mm)	(g)	(pcs.)
9	14	25	8.3	63	150	10
10	15.3	25	8.8	63	155	10
11	16.5	25	10	65	158	10
12	17.8	25	10.5	65	151	10
13	19	25	11.4	66	152	10
14	20.3	25	11.4	66	151	10
15	21.5	25	13	68	149	10
16	22.8	25	13	68	150	10
17	24	25	14	69	150	10
18	25.3	25	14	69	150	10
19	26.5	25	15	71	170	10
20	27.8	25	15	71	173	5
21	29	25	16	72	176	5
22	30.3	25	16	72	185	5

4440A (inch)	D <sub>1</sub> (mm)	D <sub>2</sub> (mm)	(mm)	L (mm)	(g)	(pcs.)
3/8	14.8	25	8.8	63	155	10
7/16	16.5	25	10	65	158	10
1/2	19	25	11.4	66	152	10
9/16	20.3	25	11.4	66	151	10
5/8	22.8	25	13	68	150	10
11/16	24.6	25	14	69	153	10
3/4	26.5	25	15	71	170	10
7/8	30.3	25	16	72	185	5

## 4440T TORX® Universal Sockets Vasos TORX® con Articulación Universal

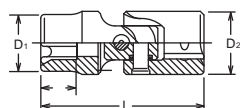

4440T (E)	D <sub>1</sub> (mm)	D <sub>2</sub> (mm)	(mm)	L (mm)	(g)	(pcs.)
E10	13.2	25	8.2	62	145	10
E12	15	25	9.3	63	147	10
E14	16.3	25	10.6	65	148	10
E16	18.8	25	11.8	65	150	10
E18	20.4	25	13	67	153	10

# 1/2" Hand Sockets

## 4117M-125 • -250 Extension Deep Sockets Vasos con Alargaderas

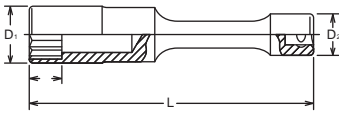

4117M.125 (mm)	D <sub>1</sub> (mm)	D <sub>2</sub> (mm)	(mm)	L (mm)	(g)	(pcs.)
13	18.7	24	13	125	213	1
14	20.2	24	14	125	227	1
17	24	24	17	125	274	1
19	26.9	24	19	125	279	1
21	28.5	24	21	125	291	1
22	30	24	22	125	323	1
24	32	24	24	125	361	1
27	36.5	24	27	125	439	1
30	40	24	30	125	461	1
32	42	24	32	125	498	1

4117M.250 (mm)	D <sub>1</sub> (mm)	D <sub>2</sub> (mm)	(mm)	L (mm)	(g)	(pcs.)
13	18.7	24	13	250	412	1
14	20.2	24	14	250	423	1
17	24	24	17	250	469	1
19	26.9	24	19	250	484	1
21	28.5	24	21	250	496	1
22	30	24	22	250	516	1
24	32	24	24	250	560	1
27	36.5	24	27	250	641	1
30	40	24	30	250	663	1
32	42	24	32	250	698	1

4000 (PH)	D (mm)	L (mm)	(g)	(pcs.)
2	22	60	65	10
3	22	60	65	10
4	22	60	67	10

## 4000-60 (PH) Phillips Bit Sockets Vasos con Punta Phillips

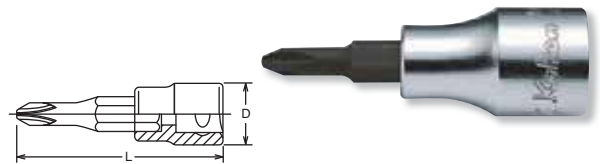

4000.60 (PZ)	D (mm)	L (mm)	(g)	(pcs.)
PZ2	22	60	65	10
PZ3	22	60	65	10

## 4000-60 (PZ) PZ Bit Sockets Vasos con Punta PZ



4005	T×W (mm)	D (mm)	L (mm)	(g)	(pcs.)
8	1.2× 8	22	60	65	10
10	1.6×10	22	60	75	10
12	2.0×12	23	60	111	10
14	2.5×14	24	60	133	10
16	2.5×16	24	60	133	10

## 4005-60 Slotted Bit Sockets Vasos con Punta Recta para Cabezas Ranuradas

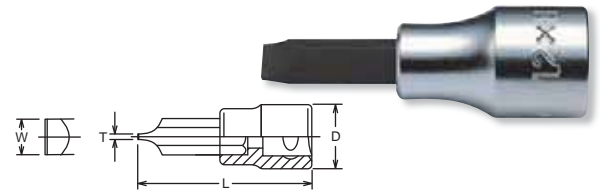

4001 (PH)	D (mm)	L (mm)	(g)	(pcs.)
1	21	60	49	10
2	21	60	53	10
3	21	60	55	10
4	21	60	57	10

## 4001 Phillips Bit Sockets Vasos con Punta Phillips

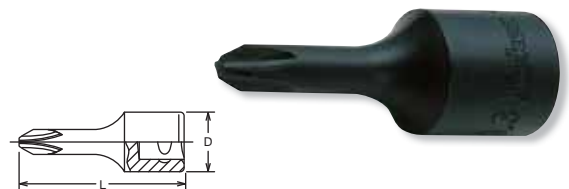

4006	T×W (mm)	D (mm)	L (mm)	(g)	(pcs.)
5	1.0× 5.5	21	60	53	10
8	1.2× 8	21	60	62	10
10	1.6×10	21	60	67	10
12	2.0×12	21	60	72	10
14	2.5×14	21	60	81	10
16	2.5×16	21	60	88	10

## 4006 Slotted Bit Sockets Vasos con Punta Recta para Cabezas Ranuradas

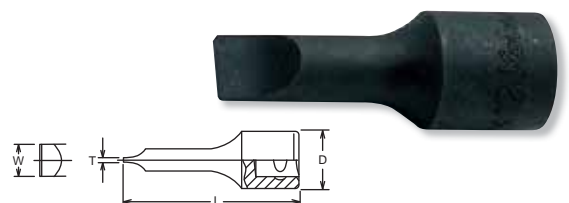

 4001, 4006 are for hand use only.  
Do not use with an impact wrench.

HAND MANUALES  
Z-SERIES  
TITANIUM DE TITANIO  
ACCESORIES ACCESORIOS  
SCREWDRIVERS DESTORNILLADORES  
IMPACT DE IMPACTO  
SLEEVE-DRIVE INDUSTRIAL INDUSTRIALES  
AUTOMOTIVE  
CONSTRUCTION CONSTRUCCION  
RENEWAL KITS JUEGOS DE PIEZAS REPUESTO

# Hand Sockets 1/2"

HAND MANUALES  
Z-SERIES  
TITANIUM DE TITANIO  
ACCESSORIES ACCESORIOS  
SCREWDRIVERS DESTORNILLADORES  
IMPACT DE IMPACTO  
SLEEVE-DRIVE  
INDUSTRIAL INDUSTRIALES  
AUTOMOTIVE  
CONSTRUCTION CONSTRUCCION  
RENEWAL KITS JUEGOS DE PIEZAS REPLUESTO

## 4010M-50 · -75 · -100 · -160

 Inhex Bit Sockets  
Vasos con Punta Hexagonal



4010M.50 (mm)	D (mm)	L (mm)	(g)	(pcs.)
4	22	50	61	10
5	22	50	62	10
6	22	50	64	10
7	22	50	65	10
8	22	50	66	10
10	22	50	75	10
12	23	50	105	10
New 13	24	50	120	10
New 14	24	50	120	10
New 16	25	50	150	10
New 17	25	50	150	10
New 18	27	50	200	10
19	27	50	200	5

4010M.75 (mm)	D (mm)	L (mm)	(g)	(pcs.)
4	22	75	69	10
5	22	75	70	10
6	22	75	72	10
7	22	75	73	10
8	22	75	74	10
10	22	75	92	10
12	23	75	130	10
New 13	24	75	150	10
New 14	24	75	150	10
New 16	25	75	180	10
New 17	25	75	180	10
New 18	27	75	230	5
19	27	75	230	5

4010M.100 (mm)	D (mm)	L (mm)	(g)	(pcs.)
4	22	100	77	10
5	22	100	78	10
6	22	100	80	10
7	22	100	82	10
8	22	100	84	10
10	22	100	109	10
12	23	100	155	10
New 13	24	100	180	10
New 14	24	100	180	5
New 16	25	100	250	5
New 17	25	100	250	5
New 18	27	100	300	5
19	27	100	300	5

4010M.160 (mm)	D (mm)	L (mm)	(g)	(pcs.)
4	22	160	103	10
5	22	160	104	10
6	22	160	106	10
7	22	160	108	10
8	22	160	110	10
10	22	160	126	10
12	23	160	180	5
14	24	160	260	5
17	25	160	360	5
19	27	160	415	5

## RS4010M/10-L50 RS4010M/10-L75

  Socket Set on Rail  
Juego de Vasos en Regleta



RS4010M/10-L50	10 Pieces Set/Rail 300mm	(g)
4, 5, 6, 7, 8, 10, 12, 14, 17, 19		968

RS4010M/10-L75	10 Pieces Set/Rail 300mm	(g)
4, 5, 6, 7, 8, 10, 12, 14, 17, 19		1,207



# 1/2" Hand Sockets

4020-60 · -100 · -120 · -140

 XZN Bit Sockets  
Vasos con Punta XZN

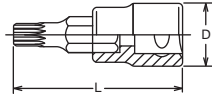

4020.60 (XZN)	D (mm)	L (mm)	(g)	(pcs.)
M 5	22	60	60	10
M 6	22	60	61	10
M 8	22	60	63	10
M10	23	60	93	10
M12	23	60	97	10
M14	24	60	105	10
M16	25	60	165	10
M18	27	60	215	10

4020.100 (XZN)	D (mm)	L (mm)	(g)	(pcs.)
M 5	22	100	77	10
M 6	22	100	78	10
M 8	22	100	80	10
M10	23	100	132	10
M12	23	100	136	10
M14	24	100	144	10
M16	25	100	250	5
M18	27	100	300	5

4020.120 (XZN)	D (mm)	L (mm)	(g)	(pcs.)
M 5	22	120	86	10
M 6	22	120	87	10
M 8	22	120	89	10
M10	23	120	152	10
M12	23	120	156	10
M14	24	120	164	10

4020.140 (XZN)	D (mm)	L (mm)	(g)	(pcs.)
M 5	22	140	95	10
M 6	22	140	96	10
M 8	22	140	98	10
M10	23	140	172	5
M12	23	140	176	5
M14	24	140	184	5

XZN



XZN		M4	M5	M6	M8	M10	M12	M14	M16	M18
S	(ref. mm)	3.60	4.80	6.00	7.20	9.60	11.41	13.22	15.63	16.85

RS4020/6-L60	6 Pieces Set/Rail 150mm	(g)
M5, M6, M8, M10, M12, M14		500

RS4020/6-L60



Socket Set on Rail  
Juego de Vasos en Regleta



HAND  
MANUALES

Z-SERIES

TITANIUM  
DE TITANIO

ACCESSORIES  
ACCESORIOS

SCREWDRIVERS  
DESTORNILLADORES

IMPACT  
DE IMPACTO

SLEEVE-DRIVE

INDUSTRIAL  
INDUSTRIALES

AUTOMOTIVE

CONSTRUCTION  
CONSTRUCCION

RENEWAL KITS  
JUEGOS DE PIEZAS REPIESTO



# Hand Sockets 1/2"

HAND MANUALES  
Z-SERIES  
TITANIUM DE TITANIO  
ACCESSORIES ACCESORIOS  
SCREWDRIVERS DESTORNILLADORES  
IMPACT DE IMPACTO  
SLEEVE-DRIVE  
INDUSTRIAL INDUSTRIALES  
AUTOMOTIVE  
CONSTRUCTION CONSTRUCCION  
RENEWAL KITS JUEGOS DE PIEZAS REPLUESTO

## 4025-60 · -100 · -140 (T)

 TORX® Bit Sockets  
Vasos con Punta TORX®

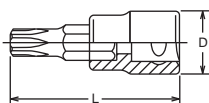

4025.60 (T)	D (mm)	L (mm)	(g)	(pcs.)
T20	22	60	59	10
T25	22	60	60	10
T27	22	60	60	10
T30	22	60	60	10
T40	22	60	62	10
T45	22	60	64	10
T50	22	60	74	10
T55	23	60	96	10
T60	24	60	122	10
T70	24	60	135	10

4025.100 (T)	D (mm)	L (mm)	(g)	(pcs.)
New T20	22	100	76	10
New T25	22	100	76	10
New T27	22	100	77	10
New T30	22	100	77	10
New T40	22	100	78	10
New T45	22	100	80	10
New T50	22	100	98	10
New T55	23	100	132	10
New T60	24	100	170	5
New T70	24	100	175	5

4025.140 (T)	D (mm)	L (mm)	(g)	(pcs.)
T20	22	140	94	10
T25	22	140	95	10
T27	22	140	95	10
T30	22	140	95	10
T40	22	140	97	10
T45	22	140	99	10
T50	22	140	129	10
T55	23	140	175	5
T60	24	140	229	5
T70	24	140	245	5

TORX® (T)

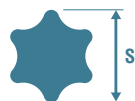

T	T8	T9	T10	T15	T20	T25	T27	T30	T40	T45	T50	T55	T60	T70	T80	T90	T100
S (ref. mm)	2.30	2.48	2.72	3.26	3.84	4.40	4.96	5.49	6.60	7.77	8.79	11.17	13.20	15.49	17.51	19.88	22.09

## RS4025/9-L60

  Socket Set on Rail  
Juego de Vasos en Regleta



RS4025/9-L60	9 Pieces Set/Rail 250mm	(g)
T20, T25, T27, T30, T40, T45, T50, T55, T60		700

## 4025-60-T35

 Bit Socket  
Vasos con Punta



4025.60 (T)	D (mm)	L (mm)	(g)	(pcs.)
T35	22	60	96	10

# 1/2" Hand Sockets

4025.60 (IP)	D (mm)	L (mm)	(g)	(pcs.)
20IP	22	60	60	10
25IP	22	60	60	10
27IP	22	60	60	10
30IP	22	60	60	10
40IP	22	60	60	10
45IP	22	60	64	10
50IP	22	60	74	10
55IP	23	60	96	10
60IP	24	60	122	10

4025.100 (IP)	D (mm)	L (mm)	(g)	(pcs.)
40IP	22	100	79	10
45IP	22	100	81	10
50IP	22	100	100	10
55IP	23	100	133	10
60IP	24	100	172	5
70IP	25	100	241	5

RS4025/9-IP	9 Pieces set/Rail 250mm	(g)
20IP, 25IP, 27IP, 30IP, 40IP, 45IP, 50IP, 55IP, 60IP		700

TORXplus® (IP)



IP	8IP	9IP	10IP	15IP	20IP	25IP	27IP	30IP	40IP	45IP	50IP	55IP	60IP	70IP
S (ref. mm)	2.29	2.48	2.72	3.25	3.84	4.39	4.95	5.49	6.60	7.77	8.79	11.16	13.20	15.49

## 4025-60 - -100 (IP)



TORX PLUS® Bit Sockets  
Vasos con Punta TORX PLUS®

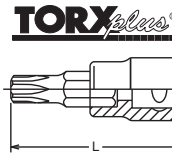

## RS4025/9-IP



Socket Set on Rail  
Juego de Vasos en Regleta



4027.60	D (mm)	L (mm)	(g)	(pcs.)
M 5	22	60	60	10
M 6	22	60	62	10
M 7	22	60	63	10
M 8	22	60	64	10
M 9	22	60	70	10
M10	22	60	74	10
M12	23	60	96	10
M13	24	60	116	10
M14	24	60	122	10
M16	24	60	135	10

4027.100	D (mm)	L (mm)	(g)	(pcs.)
M 5	22	100	67	10
M 6	22	100	68	10
M 7	22	100	75	10
M 8	22	100	81	10
M 9	22	100	90	10
M10	22	100	101	10
M12	23	100	134	10
M13	24	100	155	5
M14	24	100	173	5
M16	24	100	241	5

4027.140	D (mm)	L (mm)	(g)	(pcs.)
M 8	22	140	98	10
M10	22	140	127	5
M12	23	140	171	5
M14	24	140	226	5
M16	24	140	320	5

RS4027/6-L60	6 Pieces set/Rail 200mm	(g)
M5, M6, M8, M10, M12, M14		600

Ribe CV

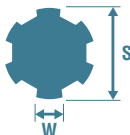

CV	M5	M6	M7	M8	M9	M10	M12	M13	M14	M16
S (ref. mm)	5	6	7	8	9	10	12	13	14	16
W (ref. mm)	1.1	1.3	1.4	1.7	1.9	2.2	2.6	3.0	3.1	3.5

## 4027-60 - -100 - -140



Bit Sockets for Ribe Screws  
Vasos con Punta para Tornillos Ribe

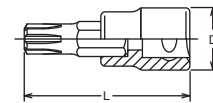

## RS4027/6-L60



Socket Set on Rail  
Juego de Vasos en Regleta



# Hand Sockets 1/2"

HAND MANUALES  
Z-SERIES  
TITANIUM DE TITANIO  
ACCESSORIES ACCESORIOS  
SCREWDRIVERS DESTORNILLADORES  
IMPACT DE IMPACTO  
SLEEVE-DRIVE  
INDUSTRIAL INDUSTRIALES  
AUTOMOTIVE  
CONSTRUCTION CONSTRUCCIÓN  
RENEWAL KITS JUEGOS DE PIEZAS REPLUESTO

## 4012M-43 · -60 · -75 · -100

 Inhex sockets  
Vasos con Punta de Hexagonal 

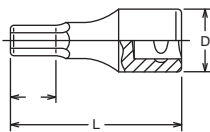

4012M.43 (mm)	D (mm)	(mm)	L (mm)	(g)	(pcs.)
4	21.1	11.5	43	40	10
5	21.1	11.5	43	41	10
6	21.1	11.5	43	42	10
7	21.1	11.5	43	46	10
8	21.1	11.5	43	50	10
9	21.1	11.5	43	50	10
10	23	11.5	43	63	10
11	25	11.5	43	80	10
12	25	11.5	43	81	10
13	25	11.5	43	85	10
14	25	11.5	43	88	10
15	26	11.5	43	105	10
16	26	11.5	43	110	10
17	26	11.5	43	115	10
18	26	11.5	43	120	10
19	26	11.5	43	125	10
20	26	11.5	43	130	10
21	26	11.5	43	135	10
22	26	11.5	43	145	10
23	28	11.5	43	167	10
24	28	11.5	43	170	10
27	32	11.5	43	226	10

4012M.60 (mm)	D (mm)	(mm)	L (mm)	(g)	(pcs.)
4	21.1	15.5	60	50	10
5	21.1	15.5	60	55	10
6	21.1	15.5	60	56	10
7	21.1	15.5	60	60	10
8	21.1	15.5	60	64	10
9	21.1	15.5	60	70	10
10	23	15.5	60	90	10
11	25	15.5	60	110	10
12	25	15.5	60	115	10
13	25	15.5	60	120	10
14	25	15.5	60	130	10
15	26	15.5	60	145	10
16	26	15.5	60	155	10
17	26	15.5	60	160	10
18	26	15.5	60	170	10
19	26	15.5	60	180	10
21	26	15.5	60	200	10
22	26	22.5	60	205	10
23	28	22.5	60	230	10
24	28	22.5	60	240	10

4012M.75 (mm)	D (mm)	(mm)	L (mm)	(g)	(pcs.)
4	21.1	15.5	75	52	10
5	21.1	15.5	75	58	10
6	21.1	15.5	75	62	10
7	21.1	15.5	75	70	10
8	21.1	15.5	75	74	10
9	21.1	15.5	75	88	10
10	23	15.5	75	105	10
11	25	15.5	75	130	10
12	25	15.5	75	135	10
13	25	15.5	75	145	10
14	25	15.5	75	160	10
15	26	15.5	75	180	10
16	26	15.5	75	190	10
17	26	15.5	75	200	10
18	26	15.5	75	210	10
19	26	15.5	75	230	10

4012M.100 (mm)	D (mm)	(mm)	L (mm)	(g)	(pcs.)
4	24	15.5	100	95	10
5	24	15.5	100	100	10
6	24	15.5	100	100	10
7	24	15.5	100	105	10
8	24	15.5	100	115	10
9	24	15.5	100	120	10
10	24	15.5	100	140	10
11	24	15.5	100	150	10
12	24	15.5	100	160	10
13	24	15.5	100	175	10
14	24	15.5	100	180	10
15	24	15.5	100	205	10
16	24	15.5	100	235	5
17	24	15.5	100	215	5
18	24	15.5	100	270	5
19	24	15.5	100	255	5

## RS4012M/10-L60

 Socket Set on Rail  
Juego de Vasos en Regleta



RS4012M/10-L60	10 Pieces set/Rail 300mm	(g)
4, 5, 6, 7, 8, 10, 12, 14, 17, 19		910

 4012M/A are for hand use only.  
Do not use with an impact wrench.

# 1/2" Hand Sockets

## 4012A-43 · -60 · -75 · -100

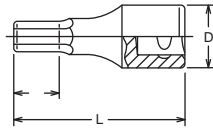

4012A.43 (inch)	D (mm)	(mm)	L (mm)	(g)	(pcs.)
5/32	21.1	11.5	43	40	10
3/16	21.1	11.5	43	46	10
7/32	21.1	11.5	43	46	10
1/4	21.1	11.5	43	46	10
9/32	21.1	11.5	43	46	10
5/16	21.1	11.5	43	49	10
11/32	21.1	11.5	43	63	10
3/8	23	11.5	43	65	10
7/16	25	11.5	43	80	10
1/2	25	11.5	43	85	10
9/16	25	11.5	43	88	10
5/8	26	11.5	43	110	10
3/4	26	11.5	43	125	10

4012A.60 (inch)	D (mm)	(mm)	L (mm)	(g)	(pcs.)
5/32	21.1	15.5	60	49	10
3/16	21.1	15.5	60	55	10
7/32	21.1	15.5	60	56	10
1/4	21.1	15.5	60	57	10
9/32	21.1	15.5	60	60	10
5/16	21.1	15.5	60	64	10
11/32	21.1	15.5	60	78	10
3/8	23	15.5	60	90	10
7/16	25	15.5	60	115	10
1/2	25	15.5	60	120	10
9/16	25	15.5	60	130	10
5/8	26	15.5	60	155	10
3/4	26	15.5	60	180	10

4012A.75 (inch)	D (mm)	(mm)	L (mm)	(g)	(pcs.)
5/32	21.1	15.5	75	52	10
3/16	21.1	15.5	75	58	10
7/32	21.1	15.5	75	62	10
1/4	21.1	15.5	75	65	10
9/32	21.1	15.5	75	70	10
5/16	21.1	15.5	75	74	10
11/32	21.1	15.5	75	88	10
3/8	23	15.5	75	105	10
7/16	25	15.5	75	130	10
1/2	25	15.5	75	145	10
9/16	25	15.5	75	160	10
5/8	26	15.5	75	190	10
3/4	26	15.5	75	230	10

4012A.100 (inch)	D (mm)	(mm)	L (mm)	(g)	(pcs.)
5/32	24	15.5	100	95	10
3/16	24	15.5	100	100	10
7/32	24	15.5	100	100	10
1/4	24	15.5	100	105	10
9/32	24	15.5	100	115	10
5/16	24	15.5	100	120	10
11/32	24	15.5	100	120	10
3/8	24	15.5	100	140	10
7/16	24	15.5	100	150	10
1/2	24	15.5	100	160	10
9/16	24	15.5	100	180	10
5/8	24	15.5	100	235	5
3/4	24	15.5	100	255	5

RS4012A/10-L60	10 Pieces set/Rail 300mm	(g)
3/16, 7/32, 1/4, 5/16, 3/8, 7/16, 1/2, 9/16, 5/8, 3/4		950

## RS4012A/10-L60



⚠ 4012M/A are for hand use only.  
Do not use with an impact wrench.

HAND MANUALES  
Z-SERIES  
TITANIUM DE TITANIO  
ACCESSORIES ACCESORIOS  
SCREWDRIVERS DESTORNILLADORES  
IMPACT DE IMPACTO  
SLEEVE-DRIVE  
INDUSTRIAL INDUSTRIALES  
AUTOMOTIVE  
CONSTRUCTION CONSTRUCCION  
RENEWAL KITS JUEGOS DE PIEZAS REPUESTO

# Hand Sockets **1/2"**

HAND  
MANUALES

Z-SERIES

TITANIUM  
DE TITANIO

ACCESSORIES  
ACCESORIOS

SCREWDRIVERS  
DESTORNILLADORES

IMPACT  
DE IMPACTO

SLEEVE-DRIVE

INDUSTRIAL  
INDUSTRIALES

AUTOMOTIVE

CONSTRUCTION  
CONSTRUCCIÓN

RENEWAL KITS  
JUEGOS DE PIEZAS REPLÉSTO

## 3749S-1/2 Reversible Ratchet Short Llave de Carraca Reversible Corta



\* Renewal Kits → 3749SRK-1/2 → P277

## 3749SB-1/2 Reversible Ratchet short with quick release button Llave de Carraca Reversible corta con botón de extracción rápida



\* Renewal Kits → 3749SBRK-1/2 → P277

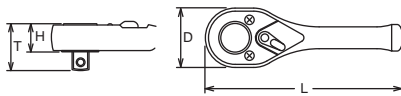

⚠ Reversible Ratchet with quick release button has less strength compared with normal ratchet due to the technical design. Make sure to use the ratchet correctly.

	D (mm)	T (mm)	H (mm)	L (mm)	(g)	(pcs.)
3749S-1/2	34	29	14.4	110	200	5
3749SB-1/2	34	29	14.4	110	200	5

## 4749N-250 Reversible Ratchet Llave de Carraca Reversible



\* Renewal Kits → 4749RK → P277

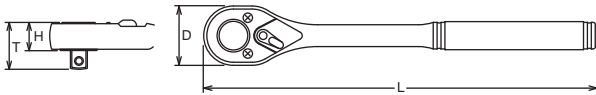

	D (mm)	T (mm)	H (mm)	L (mm)	(g)	(pce.)
4749N-250	44.6	33	18.4	250	616	1

## 4749N-380 Reversible Ratchet Long Llave de Carraca Reversible Larga



\* Renewal Kits → 4749RK → P277

## 4749J-380 Reversible Ratchet Long Llave de Carraca Reversible Larga



\* Renewal Kits → 4749RK → P277

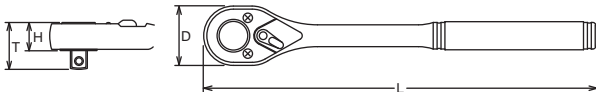

	D (mm)	T (mm)	H (mm)	L (mm)	(g)	(pce.)
4749N-380	44.6	33	18.4	380	753	1
4749J-380	44.6	33	18.4	380	743	1



## [4750 series]



Two dogs are set in the same axis and the three teeth hold the ratchet gear.  
The enlarged contact area produces an about 10% higher torque value and the S.O.D.H system provides smooth and light movements.

Se disponen dos trinquetes en el mismo eje y la rueda de la llave de carraca se bloquea por medio de tres dientes.  
El aumento de la superficie de contacto produce un aumento del par de aproximadamente 10% y el sistema S.O.D.H permite movimientos suaves y sin esfuerzo.



\* Renewal Kits → 4750RK → P277

### 4750N Reversible Ratchet Llave de Carraca Reversible



\* Renewal Kits → 4750RK → P277

### 4750P Reversible Ratchet Llave de Carraca Reversible



\* Renewal Kits → 4750RK → P277

### 4750J Reversible Ratchet Llave de Carraca Reversible



	D (mm)	T (mm)	H (mm)	L (mm)	⚖️ (g)	📦 (pce.)
4750N	38	35.9	21.3	250	548	1
4750P	38	35.9	21.3	250	553	1
4750J	38	35.9	21.3	250	508	1

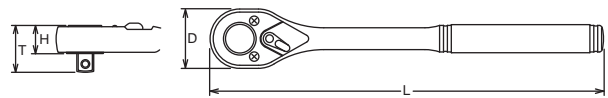

\* Renewal Kits → 4750BRK → P277

### 4750NB Reversible Ratchet with quick release button Llave de Carraca con botón de extracción rápida ⚠️



\* Renewal Kits → 4750BRK → P277

### 4750PB Reversible Ratchet with quick release button Llave de Carraca con botón de extracción rápida ⚠️



\* Renewal Kits → 4750BRK → P277

### 4750JB Reversible Ratchet with quick release button Llave de Carraca con botón de extracción rápida ⚠️



	D (mm)	T (mm)	H (mm)	L (mm)	⚖️ (g)	📦 (pce.)
4750NB	38	35.9	21.3	250	548	1
4750PB	38	35.9	21.3	250	553	1
4750JB	38	35.9	21.3	250	508	1

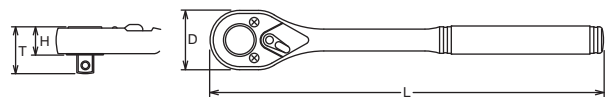

⚠️ Reversible Ratchet with quick release button has less strength compared with normal ratchet due to the technical design. Make sure to use the ratchet correctly.

# Hand Sockets 1/2"

HAND  
MANUALES

Z-SERIES

TITANIUM  
DE TITANIO

ACCESSORIES  
ACCESORIOS

SCREWDRIVERS  
DESTORNILLADORES

IMPACT  
DE IMPACTO

SLEEVE-DRIVE

INDUSTRIAL  
INDUSTRIALES

AUTOMOTIVE

CONSTRUCTION  
CONSTRUCCION

RENEWAL KITS  
JUEGOS DE PIEZAS REPLÉSTO

**4752N** Reversible Ratchet  
Llave de Carraca Reversible



\* Renewal Kits → **4752RK** → P277

**4752J** Reversible Ratchet  
Llave de Carraca Reversible



\* Renewal Kits → **4752RK** → P277

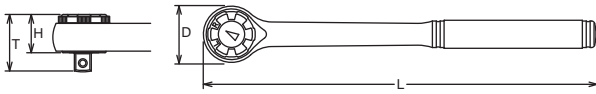

	D (mm)	T (mm)	H (mm)	L (mm)	(g)	(pce.)
<b>4752N</b>	35	38.8	24.5	250	480	1
<b>4752J</b>	35	38.8	24.5	250	470	1

## [L/R Marking]



A pointer and L/R markings on the ratchet head indicate the turning direction. The reduced diameter of the head allows easier access in tight spots.

Una flecha y unas marcas L/R en el cabezal de la llave (L = Izquierda / R = Derecha) indican el sentido de giro. El diámetro reducido del cabezal permite un acceso más fácil en lugares estrechos.

**4753N** Reversible Ratchet  
Llave de Carraca Reversible



\* Renewal Kits → **4753RK** → P277

**4753P** Reversible Ratchet  
Llave de Carraca Reversible



\* Renewal Kits → **4753RK** → P277

**4753J** Reversible Ratchet  
Llave de Carraca Reversible



\* Renewal Kits → **4753RK** → P277

**D4753J** Reversible Ratchet  
Llave de Carraca Reversible



\* Renewal Kits → **4753RK** → P277

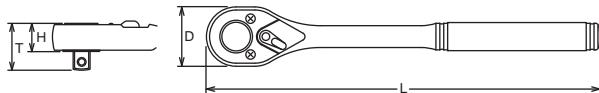

	D (mm)	T (mm)	H (mm)	L (mm)	(g)	(pce.)
<b>4753N</b>	38	36.2	21.6	250	595	1
<b>4753P</b>	38	36.2	21.6	250	570	1
<b>4753J</b>	38	36.2	21.6	250	545	1
<b>D4753J</b>	38	36.2	21.6	250	510	1

**4753P-410** Reversible Ratchet Long  
Llave de Carraca Reversible Larga



\* Renewal Kits → **4753RK** → P277

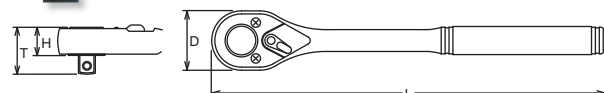

	D (mm)	T (mm)	H (mm)	L (mm)	(g)	(pce.)
<b>4753P-410</b>	38	36.2	21.6	410	790	1

# 1/2" Hand Sockets



\* Renewal Kits → 4753BRK → P277

**4753NB** Reversible Ratchet with quick release button  
Llave de Carraca Reversible con botón de extracción rápida ⚠



\* Renewal Kits → 4753BRK → P277

**4753PB** Reversible Ratchet with quick release button  
Llave de Carraca Reversible con botón de extracción rápida ⚠



\* Renewal Kits → 4753BRK → P277

**4753JB** Reversible Ratchet with quick release button  
Llave de Carraca Reversible con botón de extracción rápida ⚠



	D (mm)	T (mm)	H (mm)	L (mm)	(g)	(pce.)
4753NB	38	36.2	21.6	250	595	1
4753PB	38	36.2	21.6	250	570	1
4753JB	38	36.2	21.6	250	545	1

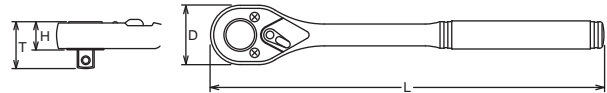

⚠ Reversible Ratchet with quick release button has less strength compared with normal ratchet due to the technical design. Make sure to use the ratchet correctly.

**Reversible Ratchet with Quick Release Button :**

Sockets and accessories are safely locked. By pushing the button the sockets or extension bars are released from the ratchet.

**Llave de Carraca Reversible con Botón de Extracción Rápida :** Los vasos y accesorios se bloquean en posición. Los vasos o las alargaderas se extraen de la llave apretando el botón.



## GEAR TEETH



4749series



4753series



4750series



4752series



4774series



HAND  
MANUALES

Z-SERIES

TITANIUM  
DE TITANIO

ACCESSORIES  
ACCESORIOS

SCREWDRIVERS  
DESTORNILLADORES

IMPACT  
DE IMPACTO

SLEEVE-DRIVE

INDUSTRIAL  
INDUSTRIALES

AUTOMOTIVE

CONSTRUCTION  
CONSTRUCCION

RENEWAL KITS  
JUEGOS DE PIEZAS REPIESTO

# Hand Sockets 1/2"

HAND  
MANUALES

Z-SERIES

TITANIUM  
DE TITANIO

ACCESSORIES  
ACCESORIOS

SCREWDRIVERS  
DESTORNILLADORES

IMPACT  
DE IMPACTO

SLEEVE-DRIVE

INDUSTRIAL  
INDUSTRIALES

AUTOMOTIVE

CONSTRUCTION  
CONSTRUCCIÓN

RENEWAL KITS  
JUEGOS DE PIEZAS/REPLUESTO

**4774N** Flexible Ratchet, Reversible  
Llave de Carraca Flexible, Reversible



\* Renewal Kits → 4753RK → P277



**4774P** Flexible Ratchet, Reversible  
Llave de Carraca Flexible, Reversible



\* Renewal Kits → 4753RK → P277



**4774J** Flexible Ratchet, Reversible  
Llave de Carraca Flexible, Reversible



\* Renewal Kits → 4753RK → P277

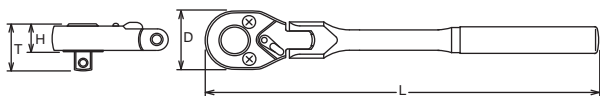

	D (mm)	T (mm)	H (mm)	L (mm)	⚖️ (g)	📦 (pce.)
4774N	38	36.2	21.6	330	700	1
4774P	38	36.2	21.6	330	700	1
4774J	38	36.2	21.6	330	685	1

**4774P-450** Flexible Ratchet, Reversible ⚠️  
Llave de Carraca Flexible, Reversible



\* Renewal Kits → 4753RK → P277

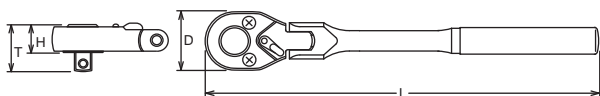

	D (mm)	T (mm)	H (mm)	L (mm)	⚖️ (g)	📦 (pce.)
4774P-450	38	36.2	21.6	450	790	1

⚠️ 4774P-450 has longer handle than standard, and can be loaded to excessive torque value. In the interest of your own safety always apply load evenly and progressively to avoid breakage and possible injury.

# 1/2" Hand Sockets



\* Renewal Kits → 4753BRK → P277

## 4774NB

Flexible Ratchet, reversible with quick release button  
Llave de Carraca Flexible, reversible con botón de extracción rápida



\* Renewal Kits → 4753BRK → P277

## 4774PB

Flexible Ratchet, reversible with quick release button  
Llave de Carraca Flexible, reversible con botón de extracción rápida



\* Renewal Kits → 4753BRK → P277

## 4774JB

Flexible Ratchet, reversible with quick release button  
Llave de Carraca Flexible, reversible con botón de extracción rápida



	D (mm)	T (mm)	H (mm)	L (mm)	(g)	(pce.)
4774NB	38	36.2	21.6	330	700	1
4774PB	38	36.2	21.6	330	700	1
4774JB	38	36.2	21.6	330	685	1

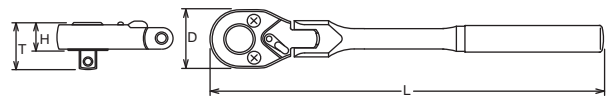

Reversible Ratchet with quick release button has less strength compared with normal ratchet due to the technical design. Make sure to use the ratchet correctly.



### Reversible Ratchet with Quick Release Button :

Sockets and accessories are safely locked. By pushing the button the sockets or extension bars are released from the ratchet.

### Llave de Carraca Reversible con Botón de

Extracción Rápida : Los vasos y accesorios se bloquean en posición. Los vasos o las alargaderas se extraen de la llave apretando el botón.



# Hand Sockets 1/2"

HAND  
MANUALES

Z-SERIES

TITANIUM  
DE TITANIO

ACCESSORIES  
ACCESORIOS

SCREWDRIVERS  
DESTORNILLADORES

IMPACT  
DE IMPACTO

SLEEVE-DRIVE

INDUSTRIAL  
INDUSTRIALES

AUTOMOTIVE

CONSTRUCTION  
CONSTRUCCION

RENEWAL KITS  
JUEGOS DE PIEZAS REPLÉSTO

## 4768N-300 Hinge Handle Mango Articulado

\* Renewal Kits → 4768RK → P278



## 4768N-380 • -450 Hinge Handle Mango Articulado

\* Renewal Kits → 4768RK → P278



## 4768P-380 • -450 Hinge Handle Mango Articulado

\* Renewal Kits → 4768RK → P278



## 4768J-380 • -450 Hinge Handle Mango Articulado

\* Renewal Kits → 4768RK → P278

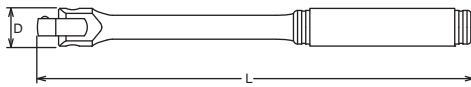
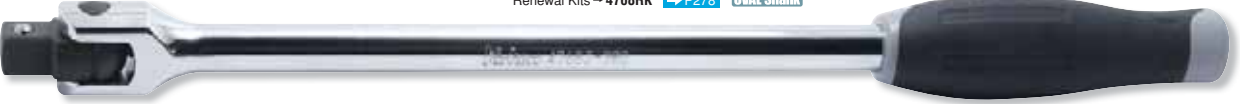

⚠ 4768-450 has longer handle than standard, and can be loaded to excessive torque value. Please use carefully.

	D (mm)	L (mm)	(g)	(pcs.)
4768N-300	28	300	600	2
4768N-380	28	380	696	2
4768N-450	28	450	784	2
4768P-380	28	380	665	2
4768P-450	28	450	748	2
4768J-380	28	380	600	1
4768J-450	28	450	690	1

## 4768N-600 Hinge Handle Mango Articulado

\* Renewal Kits → 4768RK → P278



## 4768P-600 Hinge Handle Mango Articulado

\* Renewal Kits → 4768RK → P278



## 4768J-600 Hinge Handle Mango Articulado

\* Renewal Kits → 4768RK → P278



⚠ 4768-600 has longer handle than standard, and can be loaded to excessive torque value. In the interest of your own safety always apply load evenly and progressively to avoid breakage and possible injury.

	D (mm)	L (mm)	(g)	(pcs.)
4768N-600	28	600	1100	1
4768P-600	28	600	1170	1
4768J-600	28	600	1120	1

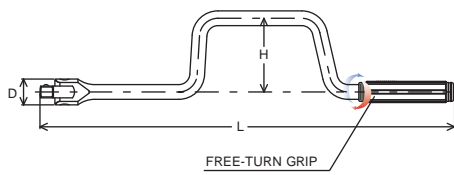

**4781N-450** Flexible Speed Handle  
Manivela Rápida Flexible



\* Renewal Kits → 4768RK → P278

	D (mm)	H (mm)	L (mm)	(g)	(pcs.)
4781N-450	28	80	450	1000	1

**4755** Ratchet Adaptor  
Adaptador de carraca



\* Renewal Kits → 4755RK → P278

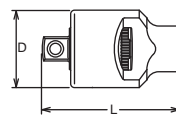

	D (mm)	L (mm)	(g)	(pcs.)
4755	33.5	65	270	5

**4756** Quick Spinner  
Disco de Giro Rápido

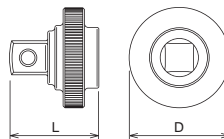

	D (mm)	L (mm)	(g)	(pcs.)
New 4756	38	34.5	95	10

**4770** Universal Joint  
Articulación Universal

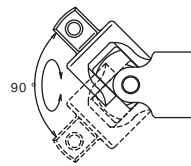
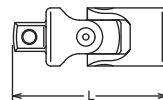

	L (mm)	(g)	(pcs.)
4770	62.4	150	10

**4771** Universal Joint  
Articulación Universal

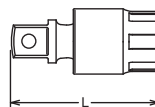

	L (mm)	(g)	(pcs.)
4771	57.7	113	10



HAND MANUALES  
Z-SERIES  
TITANIUM DE TITANIO  
ACCESSORIES ACCESORIOS  
SCREWDRIVERS DESTORNILLADORES  
IMPACT DE IMPACTO  
SLEEVE-DRIVE INDUSTRIAL INDUSTRIALES  
AUTOMOTIVE  
CONSTRUCTION CONSTRUCCION  
RENEWAL KITS JUEGOS DE PIEZAS REPERTIO

# Hand Sockets 1/2"

HAND MANUALES  
Z-SERIES  
TITANIUM DE TITANIO  
ACCESSORIES ACCESORIOS  
SCREWDRIVERS DESTORNILLADORES  
IMPACT DE IMPACTO  
SLEEVE-DRIVE  
INDUSTRIAL INDUSTRIALES  
AUTOMOTIVE  
CONSTRUCTION CONSTRUCCION  
RENEWAL KITS JUEGOS DE PIEZAS REPLUSTO

## 4760-50 • -75 • -100 • -125 • -150 • -200 • -250 • -300 • -400 • -500 • -600 • -900 • -1000

Extension Bars  
Alargaderas

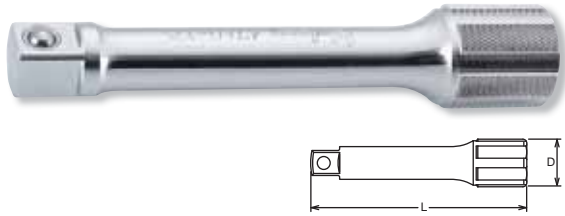

4760	D (mm)	L (mm)	(g)	(pcs.)
50	24	50	92	10
75	24	75	138	10
100	24	100	158	5
125	24	125	194	5
150	24	150	266	5
200	24	200	295	5
250	24	250	358	5
300	24	300	492	2
400	24	400	650	1
500	24	500	808	1
600	24	600	968	1
900	24	900	1430	1
1000	24	1000	1593	1

### PK4760/5 Set Juego



PK4760/5	5 Pieces Set/△=1,050g
PLASTIC TRAY	
Extension Bars	
4760 Extension Bars 50, 75, 125, 150, 250	

## 4763-50 • -75 • -125 • -150 • -250

Wobble-Fix Extension Bars  
Alargaderas Articuladas-Fijas

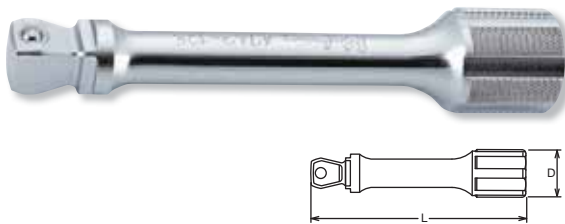

4763	D (mm)	L (mm)	(g)	(pcs.)
50	24	50	95	10
75	24	75	111	10
125	24	125	157	5
150	24	150	181	5
250	24	250	267	5

⚠ The Wobble-Fix Extension Bar has less strength than normal extension bar due to its specific design with a reduced square drive. Make sure to use it correctly.

### PK4763/5 Set Juego



PK4763/5	5 Pieces Set/△=950g
PLASTIC TRAY	
Extension Bars	
4763 Wobble-Fix Extension Bars 50, 75, 125, 150, 250	

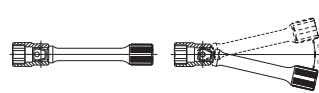

**Wobble-Fix Extension Bar**  
Two way usage : one for as a flexible extension bar to provide at 15° angle operation, the other for use as a normal extension bar. This usage is Patent.

**Alargadera Articulada-Fija**  
Dos formas de utilización : Una como alargadera flexible para poder trabajar con un ángulo de 15° y otra para utilizarse como alargadera normal. Esta aplicación está patentada.

## 4780-400 Speed Handle Manivela Rápida

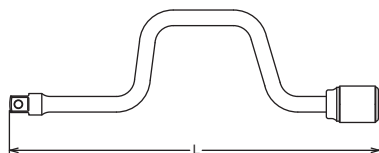

4780	L (mm)	(g)	(pce.)
4780	400	644	1



**4785** T-Handle  
Mango Corredizo



Innovative Oval shaped bar provides higher durability and stops the sliding square part turning around the bar.

	L (mm)	(g)	(pcs.)
4785	300	410	2

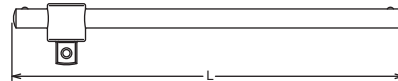

**4747** L-Handle  
Mango Acodado



	L1 (mm)	L2 (mm)	(g)	(pce.)
4747	260	50	470	1

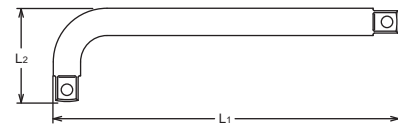

**4788-250 • -300 • -450** L-Handles  
Mango Acodado

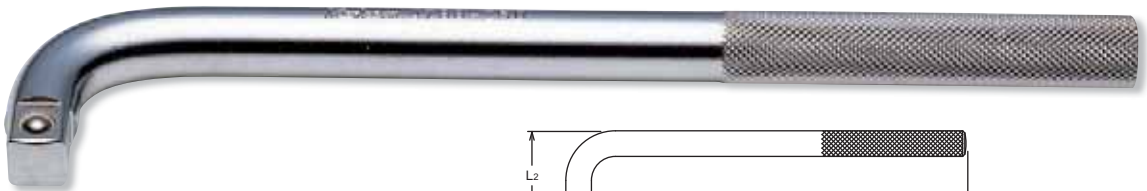

	L1 (mm)	L2 (mm)	(g)	(pcs.)
4788				
250	250	53	417	2
300	300	53	503	1
450	450	53	745	1



**4433A-35 • -125 • -250 • -600**

Adaptors  
Adaptadores Warranty 290Nm  
Garantia 290Nm ⚠

	(sq.)	(sq.)	L (mm)	(g)	(pcs.)
4433A					
35	1/2"	3/8"	35	50	10
125	1/2"	3/8"	125	164	5
250	1/2"	3/8"	250	275	5
600	1/2"	3/8"	600	530	1

⚠ Adapting down from bigger square drive to smaller square drive may lead to excessive torque and possibly cause breakage.

La adaptación de mayor a menor de un cuadrado conductor puede conducir a un par excesivo que puede causar roturas.

	(sq.)	(sq.)	L (mm)	(g)	(pcs.)
4466A	1/2"	3/4"	42	108	10

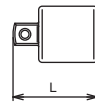

**4466A** Adaptor  
Adaptador

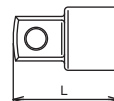

HAND  
MANUALES

Z-SERIES

TITANIUM  
DE TITANIO

ACCESSORIES  
ACCESORIOS

SCREWDRIVERS  
DESTORNILLADORES

IMPACT  
DE IMPACTO

SLEEVE-DRIVE  
INDUSTRIAL

INDUSTRIAL

AUTOMOTIVE

CONSTRUCTION  
CONSTRUCCION

RENEWAL KITS  
JUEGOS DE PIEZAS REPUESTO

# Hand Sockets 1/2"

HAND  
MANUALES

Z-SERIES

TITANIUM  
DE TITANIO

ACCESSORIES  
ACCESORIOS

SCREWDRIVERS  
DESTORNILLADORES

IMPACT  
DE IMPACTO

SLEEVE-DRIVE

INDUSTRIAL  
INDUSTRIALES

AUTOMOTIVE

CONSTRUCTION  
CONSTRUCCION

RENEWAL KITS  
JUEGOS DE PIEZAS REPLÉSTO

## 4222M Socket Set Juego de Vasos



4222M		13 Pieces Set/△=2,780g	
METAL CASE:W415xH120xT50mm			
Sockets		Accessories	
●	4405M 12-pt. Sockets 10, 11, 12, 13, 14, 17, 19, 21, 22, 24		4753N
			4760-125
			4770

## 4223M Socket Set Juego de Vasos



4223M		15 Pieces Set/△=2,600g	
METAL CASE:W415xH120xT50mm			
Sockets		Accessories	
●	4405M 12-pt. Sockets 10, 11, 12, 13, 14, 15, 16, 17, 18, 19, 21, 22		4753N
			4760-125
			4770

## 4227M Bit Socket Set Juego de Vasos con Punta



4227M		10 Pieces Set/△=2,550g	
METAL CASE:W310xH150xT50mm			
Sockets		Accessories	
●	4012M.75 Hex Bit Sockets 5, 6, 8, 10, 12, 14, 17		4749N-250
			4760-75
			4760-125

## 4230M · 4230A Socket Sets Juegos de Vasos



4230M		17 Pieces Set/△=3,150g	
METAL CASE:W395xH90xT50mm			
Sockets		Accessories	
●	4405M 12-pt. Sockets 9, 10, 12, 13, 14, 15, 16, 17, 18, 19, 21, 23, 26		4753N
			4760-125
			4768N-380
			4710

4230A		17 Pieces Set/△=3,150g	
METAL CASE:W395xH90xT50mm			
Sockets		Accessories	
●	4405A 12-pt. Sockets 3/8, 7/16, 1/2, 9/16, 19/32, 5/8, 11/16, 3/4, 25/32, 13/16, 7/8, 15/16, 1		4753N
			4760-125
			4768N-380
			4710

## 4232M Socket Set Juego de Vasos





4232M		16 Pieces Set/△=3,300g	
METAL CASE:W415xH120xT50mm			
Sockets		Accessories	
●	4405M 12-pt. Sockets 8, 9, 10, 12, 13, 14, 17, 19, 21, 22, 23, 24, 26		4753N
			4760-125
			4768N-380



# 1/2" Hand Sockets

4240M-00	4400M	32 Pieces Set	△=4,400g
4240M-05	4405M	32 Pieces Set	△=4,400g
DISPLAY STAND:W410xH160xT500mm			
Sockets			
<b>Sockets (2pcs.each)</b>			
10, 11, 12, 13, 14, 15, 16, 17, 19, 21, 22, 23, 24, 27, 30, 32			
4240A-00	4400A	32 Pieces Set	△=4,700g
4240A-05	4405A	32 Pieces Set	△=4,700g
DISPLAY STAND:W410xH160xT500mm			
Sockets			
<b>Sockets (2pcs.each)</b>			
3/8, 7/16, 1/2, 9/16, 19/32, 5/8, 11/16, 3/4, 13/16, 7/8, 15/16, 1, 1.1/16, 1.1/8, 1.3/16, 1.1/4			

**4240M-00 · 4240A-00**  Display Stands Expositores  
**4240M-05 · 4240A-05** 



S4240M-00	4400M	117 Pieces Set	△=13,000g
S4240M-05	4405M	117 Pieces Set	△=13,000g
DISPLAY STAND:W510xH150xT230mm			
Sockets			
10mm:9pcs	16mm:9pcs	24mm:6pcs	
11mm:9pcs	17mm:8pcs	27mm:5pcs	
12mm:9pcs	19mm:7pcs	30mm:5pcs	
13mm:9pcs	21mm:7pcs	32mm:4pcs	
14mm:9pcs	22mm:6pcs		
15mm:9pcs	23mm:6pcs		
S4240A-00	4400A	103 Pieces Set	△=13,000g
S4240A-05	4405A	103 Pieces Set	△=13,000g
DISPLAY STAND:W510xH150xT230mm			
Sockets			
3/8" :9pcs	11/16":8pcs	1" :5pcs	
7/16":9pcs	3/4" :7pcs	1.1/16":5pcs	
1/2" :9pcs	13/16":7pcs	1.1/8" :5pcs	
9/16":9pcs	7/8" :6pcs	1.3/16":5pcs	
5/8" :9pcs	15/16":6pcs	1.1/4" :4pcs	

**S4240M-00 · S4240A-00**  Display Stands Expositores  
**S4240M-05 · S4240A-05** 



HAND MANUALES  
 Z-SERIES  
 TITANIUM DE TITANIO  
 ACCESORIES ACCESORIOS  
 SCREWDRIVERS DESTORNILLADORES  
 IMPACTO DE IMPACTO  
 SLEEVE-DRIVE INDUSTRIAL INDUSTRIALES  
 AUTOMOTIVE  
 CONSTRUCTION CONSTRUCCION  
 RENEWAL KITS JUEGOS DE PIEZAS REPIESTO

# Hand Sockets 1/2"

HAND  
MANUALES

Z-SERIES

TITANIUM  
DE TITANIO

ACCESSORIES  
ACCESORIOS

SCREWDRIVERS  
DESTORNILLADORES

IMPACT  
DE IMPACTO

SLEEVE-DRIVE

INDUSTRIAL  
INDUSTRIALES

AUTOMOTIVE

CONSTRUCTION  
CONSTRUCCION

RENEWAL KITS  
JUEGOS DE PIEZAS REPLUESTO

## 4238AM Socket Set Juego de Vasos



4238AM 38 Pieces Set/△=8,050g

METAL CASE:W446xH266xT50mm

Sockets	Accessories
<b>4405M</b> 12-pt. Sockets 10, 11, 12, 13, 14, 15, 16, 17, 18, 19, 21, 22, 23, 24, 26, 27, 30, 32	<b>4753N</b> <b>4760-125</b> <b>4760-250</b> <b>4770</b> <b>4780</b> <b>4785</b>
<b>4405A</b> 12-pt. Sockets 3/8, 7/16, 1/2, 9/16, 5/8, 11/16, 3/4, 13/16, 7/8, 15/16, 1.1/16, 1.1/8, 1.1/4	
<b>4300C</b> Spark Plug Socket 20.8	

## 4241M Socket Set Juego de Vasos



4241M 28 Pieces Set/△=6,500g

METAL CASE:W445xH190xT50mm

Sockets	Accessories
<b>4405M</b> 12-pt. Sockets 10, 11, 12, 13, 14, 15, 16, 17, 18, 19, 20, 21, 22, 23, 24, 25, 26, 27, 28, 29, 30, 32	<b>4753N</b> <b>4760-125</b> <b>4760-250</b> <b>4768N-380</b> <b>4770</b> <b>4785</b>

## 4241A Socket Set Juego de Vasos



4241A 19 Pieces Set/△=5,350g

METAL CASE:W445xH190xT50mm

Sockets	Accessories
<b>4405A</b> 12-pt. Sockets 3/8, 7/16, 1/2, 9/16, 5/8, 11/16, 3/4, 13/16, 7/8, 15/16, 1.1/16, 1.1/8, 1.1/4	<b>4753N</b> <b>4760-125</b> <b>4760-250</b> <b>4768N-380</b> <b>4770</b> <b>4785</b>

## 4244M • 4244A Socket Sets Juegos de Vasos



4244M 22 Pieces Set/△=5,500g







METAL CASE:W445xH190xT50mm

Sockets	Accessories
<b>4405M</b> 12-pt. Sockets 9, 10, 12, 13, 14, 15, 16, 17, 18, 19, 21, 23, 26, 29, 32	<b>4753N</b> <b>4760-125</b> <b>4760-250</b> <b>4768N-380</b> <b>4770</b> <b>4785</b> <b>4710</b>

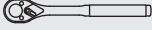
4244A 22 Pieces Set/△=5,650g





METAL CASE:W445xH190xT50mm

Sockets	Accessories
<b>4405A</b> 12-pt. Sockets 3/8, 7/16, 1/2, 9/16, 19/32, 5/8, 11/16, 3/4, 25/32, 13/16, 7/8, 15/16, 1, 1.1/8, 1.1/4	<b>4753N</b> <b>4760-125</b> <b>4760-250</b> <b>4768N-380</b> <b>4770</b> <b>4785</b> <b>4710</b>

<b>4248M</b> 24 Pieces Set/△=5,700g	
METAL CASE:W445xH190xT50mm	
Sockets	Accessories
<b>4405M</b> 12-pt. Sockets 10, 11, 12, 13, 14, 15, 16, 17, 18, 19, 21, 22, 23, 24, 26, 27, 30, 32	 <b>4753N</b>  <b>4760-125</b>  <b>4760-250</b>  <b>4770</b>  <b>4780</b>  <b>4785</b>

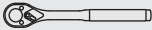
**4248M** Socket Set  
Juego de Vasos

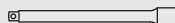

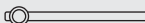
<b>4250M</b> 18 Pieces Set/△=3,700g	
METAL CASE:W445xH190xT50mm	
Sockets	Accessories
<b>4405M</b> 12-pt. Sockets 10, 11, 12, 13, 14, 15, 17, 19, 22, 24, 27, 30, 32	 <b>4753N</b>  <b>4760-125</b>  <b>4760-250</b>  <b>4770</b>  <b>4785</b>

**4250M** Socket Set  
Juego de Vasos



<b>4251M</b> 22 Pieces Set/△=3,200g	
METAL CASE:W330xH68xT48mm	
Sockets	
<b>4405M</b> 12-pt. Sockets 10, 11, 12, 13, 14, 15, 16, 17, 18, 19, 20, 21, 22, 23, 24, 25, 26, 27, 28, 29, 30, 32	

**4251M · 4251A** Socket Sets  
Juegos de Vasos









<b>4251A</b> 18 Pieces Set/△=2,660g	
METAL CASE:W330xH68xT48mm	
Sockets	
<b>4405A</b> 12-pt. Sockets 3/8, 7/16, 1/2, 9/16, 5/8, 19/32, 21/32, 11/16, 3/4, 25/32, 13/16, 7/8, 15/16, 1, 1.1/16, 1.1/8, 1.3/16, 1.1/4	

<b>4252M</b> 13 Pieces Set/△=1,200g	
METAL CASE:W168xH60xT42mm	
Sockets	
<b>4405M</b> 12-pt. Sockets 10, 11, 12, 13, 14, 15, 16, 17, 18, 19, 20, 21, 22	

**4252M · 4252A** Socket Sets  
Juegos de Vasos



<b>4252A</b> 13 Pieces Set/△=1,300g	
METAL CASE:W168xH60xT42mm	
Sockets	
<b>4405A</b> 12-pt. Sockets 3/8, 7/16, 1/2, 9/16, 19/32, 5/8, 21/32, 11/16, 3/4, 25/32, 13/16, 7/8, 15/16	

<b>4254</b> 12 Pieces Set/△=1,070g	
METAL CASE:W215xH80xT47mm	
Sockets	Accessories
 <b>3425-</b> E6, E8	 <b>4763-50</b>
 <b>4425-</b> E10, E12, E14	 <b>4433A-35</b>
 <b>3325-</b> E6, E8	
 <b>4325-</b> E10, E12, E14	

**4254** Socket Set  
Juego de Vasos





# Hand Sockets 1/2"

HAND  
MANUALES

Z-SERIES

TITANIUM  
DE TITANIO

ACCESSORIES  
ACCESORIOS

SCREWDRIVERS  
DESTORNILLADORES

IMPACT  
DE IMPACTO

SLEEVE-DRIVE

INDUSTRIAL  
INDUSTRIALES





AUTOMOTIVE

CONSTRUCTION  
CONSTRUCCION

RENEWAL KITS  
JUEGOS DE PIEZAS REPLÉSTO

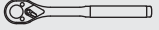



## 4261M Socket Set Juego de Vasos



4261M 18 Pieces Set/△=4,870g	
METAL CASE:W445xH190xT50mm	
Sockets	Accessories
<b>4405M 12-pt. Sockets</b> 8, 10, 11, 12, 13, 14, 17, 19, 21, 22, 24, 26, 27	 <b>4753N</b>  <b>4760-125</b>  <b>4760-250</b>  <b>4768N-380</b>  <b>4770</b>

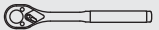

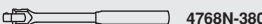
## 4263M Socket Set Juego de Vasos

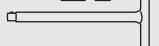

4263M 21 Pieces Set/△=6,100g	
METAL CASE:W445xH190xT50mm	
Sockets	Accessories
<b>4405M 12-pt. Sockets</b> 8, 10, 11, 12, 13, 14, 15, 17, 19, 21, 22, 23, 24, 26, 27	 <b>4753N</b>  <b>4760-125</b>  <b>4760-250</b>  <b>4768N-380</b>  <b>4770</b>  <b>4715S</b>

## 4273AM Socket Set Juego de Vasos

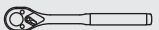
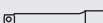
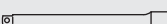
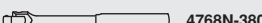

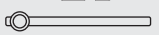









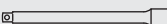

4273AM 30 Pieces Set/△=6,940g	
METAL CASE:W446xH266xT50mm	
Sockets	Accessories
<b>4405M 12-pt. Sockets</b> 10, 11, 12, 13, 14, 17, 19, 21, 22, 23, 24, 26, 27	 <b>4753N</b>  <b>4760-125</b>  <b>4760-250</b>  <b>4768N-380</b>  <b>4770</b>  <b>4785</b>
<b>4405A 12-pt. Sockets</b> 3/8, 7/16, 1/2, 9/16, 5/8, 11/16, 3/4, 13/16, 7/8, 15/16, 1	

## P4241M-01 Socket Sets Juegos de Vasos

## P4241M-06







P4241M-01 28 Pieces Set/△=6,400g	
PLASTIC CASE:W425xH332xT65mm	
Sockets	Accessories
<b>4401M 6-pt. Sockets</b> 10, 11, 12, 13, 14, 15, 16, 17, 18, 19, 20, 21, 22, 23, 24, 25, 26, 27, 28, 29, 30, 32	 <b>4753J</b>  <b>4760-125</b>  <b>4760-250</b>  <b>4768J-380</b>  <b>4770</b>  <b>4785</b>

P4241M-06 28 Pieces Set/△=6,400g	
PLASTIC CASE:W425xH332xT65mm	
Sockets	Accessories
<b>4406M 12-pt. Sockets</b> 10, 11, 12, 13, 14, 15, 16, 17, 18, 19, 20, 21, 22, 23, 24, 25, 26, 27, 28, 29, 30, 32	 <b>4753J</b>  <b>4760-125</b>  <b>4760-250</b>  <b>4768J-380</b>  <b>4770</b>  <b>4785</b>

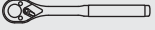
# 1/2" Hand Sockets

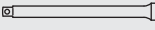
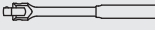
HAND MANUALES  
Z-SERIES  
TITANIUM DE TITANIO  
ACCESSORIES ACCESORIOS  
SCREWDRIVERS DESTORNILLADORES  
IMPACT DE IMPACTO  
SLEEVE-DRIVE  
INDUSTRIAL INDUSTRIALES  
AUTOMOTIVE  
CONSTRUCTION CONSTRUCCION  
RENEWAL KITS JUEGOS DE PIEZAS REPIESTO

<b>4275</b> 24 Pieces Set/△=5.340g	
METAL CASE:W445xH190xT50mm	
Sockets	Accessories
<b>4400M</b> 6-pt. Sockets 10, 11, 12, 13, 14, 15, 16, 17, 18, 19, 21, 22, 24	 <b>4750N</b>  <b>4760-125</b>  <b>4760-250</b>  <b>4768N-380</b>  <b>4770</b>  <b>4785</b>
<b>4300C</b> Spark Plug Sockets 16, 20.8	
<b>4300M</b> Wheel Nut Sockets 17(L60), 19(L60), 21(L60)	



**4275** Socket Set  
Juego de Vasos

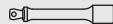

<b>4276</b> 17 Pieces Set/△=2.890g	
METAL CASE:W370xH150xT50mm	
Sockets	Accessories
<b>4010M.50</b> Bit Sockets 6, 7, 8, 10, 12, 14	 <b>4752N</b>  <b>4763-125</b>
<b>4025.60</b> TORX® Bit Sockets T20, T25, T27, T30, T40, T45, T50, T55, T60	

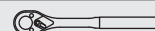

**4276** Socket Set  
Juego de Vasos

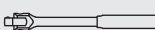

<b>4277</b> 27 Pieces Set/△=5.660g	
METAL CASE:W445xH190xT50mm	
Sockets	Accessories
<b>4405M</b> 12-pt. Sockets 10, 12, 13, 14, 15, 16, 17, 18, 19, 21, 22, 24	 <b>4750N</b>  <b>4760-125</b>  <b>4768N-380</b>
<b>4305M</b> 12-pt. Deep Sockets 10, 12, 13, 14, 15, 16, 17, 18, 19, 21, 22, 24	



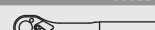
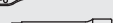
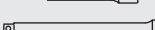
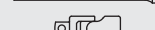

**4277** Socket Set  
Juego de Vasos

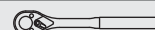

<b>4279AM</b> 36 Pieces Set/△=6.000g	
METAL CASE:W445xH190xT50mm	
Sockets	Accessories
<b>4405M</b> 12-pt. Sockets 10, 11, 12, 13, 14, 15, 16, 17, 18, 19, 21, 22, 23, 24, 26, 27, 30, 32	 <b>4753N</b>  <b>4760-125</b>  <b>4760-250</b>  <b>4770</b>  <b>4785</b>
<b>4405A</b> 12-pt. Sockets 3/8, 7/16, 1/2, 9/16, 5/8, 11/16, 3/4, 13/16, 7/8, 15/16, 1.1/16, 1.1/8, 1.1/4	

**4279AM** Socket Set  
Juego de Vasos

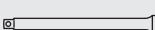
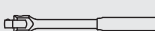

<b>4289M</b> 18 Pieces Set/△=4.200g	
METAL CASE:W445xH190xT50mm	
Sockets	Accessories
<b>4405M</b> 12-pt. Sockets 8, 10, 12, 13, 14, 17, 19, 21, 22, 24, 27, 30, 32	 <b>4753N</b>  <b>4760-125</b>  <b>4760-250</b>  <b>4768N-450</b>  <b>4771</b>

**4289M** Socket Set  
Juego de Vasos





# Hand Sockets 3/4"

HAND  
MANUALES

Z-SERIES

TITANIUM  
DE TITANIO

ACCESSORIES  
ACCESORIOS

SCREWDRIVERS  
DESTORNILLADORES

IMPACT  
DE IMPACTO

SLEEVE-DRIVE

INDUSTRIAL  
INDUSTRIALES

AUTOMOTIVE

CONSTRUCTION  
CONSTRUCCION



RENEWAL KITS  
JUEGOS DE PIEZAS REPLUSTO

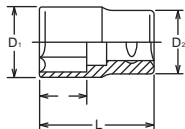

## 6400M • 6400A 6-point Sockets Vasos Hexagonales

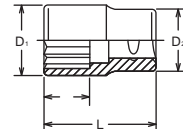

## 6405M • 6405A 12-point Sockets Vasos Bihexagonales





6400M 6405M (mm)	D <sub>1</sub> (mm)	D <sub>2</sub> (mm)	(mm)	L (mm)	 (g)	 (pcs.)
17	26	34	12.5	50	175	5
18	27	34	13	50	178	5
19	28.5	34	13.5	50	179	5
20	29.5	34	14	50	185	5
21	31	34	14.5	50	185	5
22	32	34	15	50	187	5
23	33.5	34	16	50	187	5
24	34.5	34	17	50	200	5
25	36	34	17.5	50	217	5
26	37	34	18	50	222	5
27	38.5	37	19	53	254	5
28	39.5	38	19.5	53	298	5
29	41	38	20	55	292	5
30	42	38	21	55	301	5
31	43.5	38	22	57	294	5
32	44.5	40	23	57	351	5
33	46	40	23.5	57	384	5
34	47	40	24	57	397	5
35	48.5	42	24.5	59	422	5
36	49.5	42	25	59	438	5
37	51	42	25.5	59	484	5
38	52	45	26	59	523	5
39	53.5	45	26.5	59	538	5
40	54.5	45	27	62	550	5
41	56	47	28	62	633	5
42	57	47	28.5	62	652	2
43	58.5	47	29	62	659	2
44	59.5	47	29.5	62	657	2
45	61	47	30	68	734	2
46	62	47	31	68	791	2
47	63.5	48	31.5	68	816	2
48	64.5	45	32	68	800	2
50	67	48	34	68	880	2
52	69.5	53	33	72	925	2
54	72	55	33	72	1040	2
55	73.5	53	36	72	1006	2
56	74.5	53	36	72	1092	2
57	76	53	36	72	1169	2
58	77	53	36	72	1149	2
60	79.5	58	39	76	1402	2
63	83.5	58	39	76	1494	2
65	86	63	42	80	1608	2
70	92	68	45	84	1785	2
75	98.5	73	48	86	2186	1
80	104.5	78	52	90	2475	1
85	111	78	52	90	2620	1

6400A 6405A (inch)	D <sub>1</sub> (mm)	D <sub>2</sub> (mm)	(mm)	L (mm)	 (g)	 (pcs.)
11/16	27	34	13	50	178	5
3/4	28.5	34	13.5	50	179	5
25/32	29.5	34	14	50	185	5
13/16	31	34	14.5	50	185	5
7/8	32	34	15	50	187	5
15/16	34.5	34	17	50	200	5
31/32	36	34	17.5	50	217	5
1	37	34	18	50	222	5
1. 1/16	38.5	37	19	53	254	5
1. 1/8	41	38	20	53	292	5
1. 3/16	42	38	21	55	301	5
1. 1/4	44.5	40	23	57	351	5
1. 5/16	46	40	23.5	57	384	5
1. 3/8	48.5	42	24.5	57	422	5
1. 7/16	51	42	25.5	59	484	5
1. 1/2	52	45	26	59	523	5
1. 9/16	54.5	45	27	59	550	5
1. 5/8	56	47	28	62	633	5
1.11/16	58.5	47	29	62	659	2
1. 3/4	59.5	47	29.5	62	657	2
1.13/16	62	47	31	68	791	2
1. 7/8	64.5	45	32	68	800	2
1.15/16	66	48	32.5	68	870	2
2	68.5	52	34.5	68	949	2
2. 1/16	71	54	33	72	983	2
2. 1/8	72	55	33	72	1040	2
2. 3/16	74.5	53	36	72	1092	2
2. 1/4	76	53	36	72	1169	2
2. 5/16	78.5	53	36	72	1344	2
2. 3/8	79.5	58	39	76	1402	2
2. 7/16	82	58	39	76	1420	2
2. 1/2	84.5	58	39	76	1497	2
2. 9/16	86	63	42	80	1608	2
2. 5/8	88.5	63	42	80	1709	2
2.11/16	89.5	63	42	80	1634	2
2. 3/4	92	68	45	84	1785	2
2.13/16	94.5	68	45	84	2018	2
2. 7/8	96	68	45	84	2062	2
2.15/16	98.5	73	48	86	2186	1
3	101	73	48	86	2309	1
3. 1/8	104.5	78	52	90	2475	1

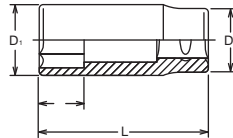

## 6300M • 6300A 6-point Deep Sockets Vasos Hexagonales Largos





6300M 6305M (mm)	D <sub>1</sub> (mm)	D <sub>2</sub> (mm)	(mm)	L (mm)	 (g)	 (pcs.)
17	26	34	18	90	278	5
18	27	34	19	90	281	5
19	28.5	34	20	90	292	5
20	29.5	34	21	90	334	5
21	31	34	22	90	343	5
22	32	34	23	90	347	5
23	33.5	34	24	90	361	5
24	34.5	34	25	90	352	5
25	36	34	26	90	369	5
26	37	34	27	90	384	5
27	38.5	37	28	90	425	5
28	39.5	38	29	90	470	5
29	41	38	30	90	503	5
30	42	38	31	90	503	5
31	43.5	38	32	90	517	5
32	44.5	40	34	90	544	5
33	46	40	34	90	557	5
34	47	40	35	90	570	5
35	48.5	42	36	90	622	5
36	49.5	42	37	90	631	2
38	52	45	39	90	710	2
40	54.5	45	41	90	742	2
41	56	47	42	90	802	2
42	57	47	43	90	829	2
44	59.5	47	45	90	838	2
46	62	47	47	90	906	2
48	64.5	50	49	90	998	2
50	67	48	51	90	1005	2
52	69.5	53	49	100	1270	2
53	71	54	49	100	1338	2
54	72	55	49	100	1351	2
55	73.5	53	52	100	1388	2
56	74.5	53	52	100	1389	2
57	76	53	52	100	1467	2
58	77	53	52	100	1480	2
60	79.5	58	55	100	1626	2
63	83.5	58	55	100	1740	2

## 6305M • 6305A 12-point Deep Sockets Vasos Bihexagonales Largos



6300A 6305A (inch)	D <sub>1</sub> (mm)	D <sub>2</sub> (mm)	(mm)	L (mm)	 (g)	 (pcs.)
3/4	28.5	34	20	90	292	5
25/32	29.5	34	21	90	334	5
13/16	31	34	22	90	343	5
7/8	32	34	23	90	347	5
15/16	34.5	34	25	90	352	5
1	37	34	27	90	384	5
1. 1/16	38.5	37	28	90	425	5
1. 1/8	41	38	30	90	503	5
1. 3/16	42	38	31	90	503	5
1. 1/4	44.5	40	34	90	544	5
1. 5/16	46	40	34	90	557	5
1. 3/8	48.5	42	36	90	622	5
1. 7/16	51	42	38	90	656	2
1. 1/2	52	45	39	90	710	2
1. 9/16	54.5	45	41	90	742	2
1. 5/8	56	47	42	90	802	2
1.11/16	58.5	47	44	90	831	2
1. 3/4	59.5	47	45	90	838	2
1.13/16	62	47	47	90	906	2
2	68.5	52	52	90	1061	2
2. 1/16	71	54	49	100	1338	2
2. 1/8	72	55	49	100	1351	2
2. 3/16	74.5	53	52	100	1389	2
2. 1/4	76	53	52	100	1467	2
2. 5/16	78.5	53	52	100	1787	2
2. 3/8	79.5	58	55	100	1626	2
2. 7/16	82	58	55	100	1715	2

6012M.75 (mm)	D (mm)	(mm)	L (mm)	 (g)	 (pcs.)
12	35	15.5	75	253	10
14	35	15.5	75	265	10
15	35	15.5	75	280	10
16	35	15.5	75	285	10
17	35	15.5	75	292	10
18	35	15.5	75	302	10
19	35	15.5	75	312	10
20	35	15.5	75	323	10
22	38	22.5	75	340	10
24	38	22.5	75	362	10
27	38	22.5	75	402	10
30	38	28.5	75	445	10
32	38	28.5	75	485	10
36	42	28.5	75	540	10

## 6012M-75 Inhex Sockets Vasos con Punta Hexagonal

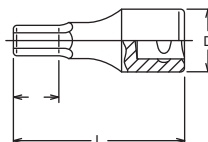

HAND  
MANUALES

Z-SERIES

TITANIUM  
DE TITANIO

ACCESSORIES  
ACCESORIOS

SCREWDRIVERS  
DESTORNILLADORES

IMPACT  
DE IMPACTO

SLEEVE-DRIVE  
INDUSTRIAL

INDUSTRIAL  
INDUSTRIALES

AUTOMOTIVE

CONSTRUCTION  
CONSTRUCCION

RENEWAL KITS  
JUEGOS DE PIEZAS REPUESTO

# Hand Sockets **3/4"**

HAND  
MANUALES

Z-SERIES

TITANIUM  
DE TITANIO

ACCESSORIES  
ACCESORIOS

SCREWDRIVERS  
DESTORNILLADORES

IMPACT  
DE IMPACTO

SLEEVE-DRIVE

INDUSTRIAL  
INDUSTRIALES

AUTOMOTIVE

CONSTRUCTION  
CONSTRUCCION

RENEWAL KITS  
JUEGOS DE PIEZAS/REPLUSTO

**6749** Reversible Ratchet  
Llave de Carraca Reversible



\* Renewal Kits → **6749RK** → P277

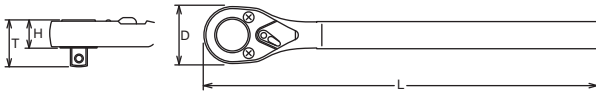

	D (mm)	T (mm)	H (mm)	L (mm)	(g)	(pce.)
<b>6749</b>	68	49.6	29.6	565	2800	1

**6749-1000** Reversible Ratchet  
Llave de Carraca Reversible



\* Renewal Kits → **6749RK** → P277

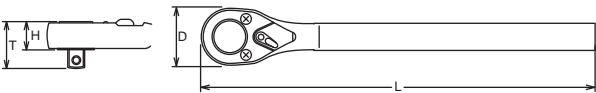

	D (mm)	T (mm)	H (mm)	L (mm)	(g)	(pce.)
<b>6749-1000</b>	68	49.6	29.6	1000	3600	1

**6752** Reversible Ratchet  
Llave de Carraca Reversible



\* Renewal Kits → **6752RK** → P277

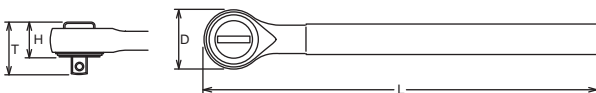

	D (mm)	T (mm)	H (mm)	L (mm)	(g)	(pce.)
<b>6752</b>	67	55.5	35.5	500	2380	1

**6755** Ratchet Adaptor  
Adaptador de carraca

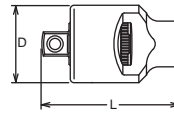

**60**

\* Renewal Kits → **6755RK** → [P278](#)

	D (mm)	L (mm)	(g)	(pcs.)
<b>6755</b>	62	97	1162	1



**6760-75 · -100 · -125 · -150 · -200 · -300 · -400** Extension Bars  
Alargaderas



6760	D (mm)	L (mm)	(g)	(pcs.)
<b>75</b>	35	75	335	10
<b>100</b>	35	100	434	10
<b>125</b>	35	125	528	10
<b>150</b>	35	150	624	2
<b>200</b>	35	200	815	1
<b>300</b>	35	300	1203	1
<b>400</b>	35	400	1585	1



# Hand Sockets 3/4"

HAND MANUALES  
Z-SERIES  
TITANIUM DE TITANIO  
ACCESSORIES ACCESORIOS  
SCREWDRIVERS DESTORNILLADORES  
IMPACT DE IMPACTO  
SLEEVE-DRIVE  
INDUSTRIAL INDUSTRIALES  
AUTOMOTIVE  
CONSTRUCTION CONSTRUCCION  
RENEWAL KITS JUEGOS DE PIEZAS REPLÉSTO

**6768** Hinge Handle  
Mango Articulado

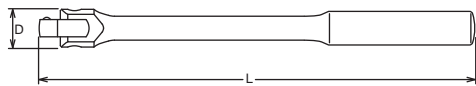

\* Renewal Kits → **6768RK** → **P278**

	D (mm)	L (mm)	(g)	(pce.)
<b>6768</b>	42	450	1715	1

**6768-600 · -1000** Hinge Handles  
Mangos Articulados

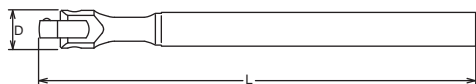

\* Renewal Kits → **6768RK** → **P278**

	D (mm)	L (mm)	(g)	(pce.)
6768				
<b>600</b>	42	600	2800	1
<b>1000</b>	42	1000	3400	1

**6785** T-Handle  
Mango Corredizo

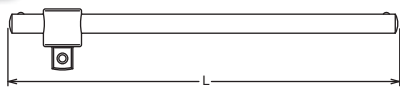

	L (mm)	(g)	(pce.)
<b>6785</b>	500	1542	1

**6788** L-Handle  
Mango Acodado

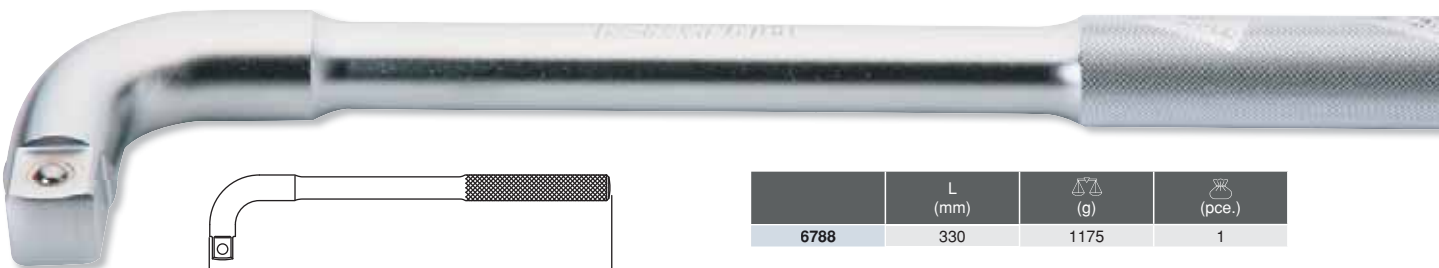

	L (mm)	(g)	(pce.)
<b>6788</b>	330	1175	1



**6770** Universal Joint  
Articulación Universal



	L (mm)	(g)	(pcs.)
<b>6770</b>	105	478	2

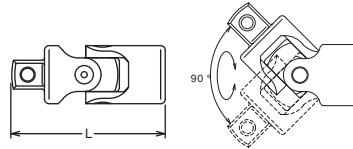

**6644A** Adaptor Warranty 668Nm  
Adaptador Garantía 668Nm 

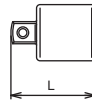

**6688A** Adaptor  
Adaptador

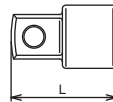

	(sq.)	(sq.)	L (mm)	(g)	(pcs.)
<b>6644A</b>	3/4"	1/2"	47	136	5
<b>6688A</b>	3/4"	1"	60	285	5

 Adapting down from bigger square drive to smaller square drive may lead to excessive torque and possibly cause breakage.





La adaptación de mayor a menor de un cuadrado conductor puede conducir a un par excesivo que puede causar roturas.



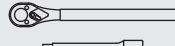

# Hand Sockets 3/4"

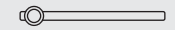
HAND MANUALES  
Z-SERIES  
TITANIUM DE TITANIO  
ACCESSORIES ACCESORIOS  
SCREWDRIVERS DESTORNILLADORES  
IMPACT DE IMPACTO  
SLEEVE-DRIVE  
INDUSTRIAL INDUSTRIALES  
AUTOMOTIVE  
CONSTRUCTION CONSTRUCCION  
RENEWAL KITS JUEGOS DE PIEZAS REPLÉSTO

## 6201M • 6201A Socket Sets Juegos de Vasos

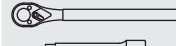

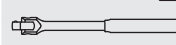
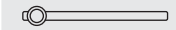



6201M		16 Pieces Set/△=17,300g	
METAL CASE:W580×H200×T85mm			
Sockets		Accessories	
 <b>6405M</b> 12-pt. Sockets 22, 24, 27, 30, 32, 36, 41, 46, 50, 55, 60		6749	
		6760-200	
		6760-400	
		6768	
		6785	

6201A		18 Pieces Set/△=17,600g	
METAL CASE:W580×H200×T85mm			
Sockets		Accessories	
 <b>6405A</b> 12-pt. Sockets 7/8, 15/16, 1.1/16, 1.1/8, 1.1/4, 1.5/16, 1.7/16, 1.1/2, 1.5/8, 1.11/16, 1.13/16, 1.7/8, 2		6749	
		6760-200	
		6760-400	
		6768	
		6785	

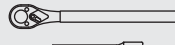
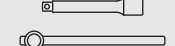
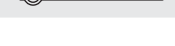
## 6212M • 6212A Socket Sets Juegos de Vasos











6212M		12 Pieces Set/△=11,000g	
METAL CASE:W580×H124×T70mm			
Sockets		Accessories	
 <b>6405M</b> 12-pt. Sockets 22, 24, 27, 30, 32, 36, 41, 46, 50		6749	
		6760-200	
		6785	



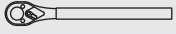

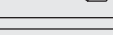



6212A		12 Pieces Set/△=11,000g	
METAL CASE:W580×H124×T70mm			
Sockets		Accessories	
 <b>6405A</b> 12-pt. Sockets 7/8, 15/16, 1.1/16, 1.3/16, 1.1/4, 1.7/16, 1.5/8, 1.13/16, 2		6749	
		6760-200	
		6785	

Sockets in sets can be supplied in 6-pt. or 12-pt. format.

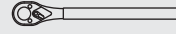
## 6260M • 6260A Socket Sets Juegos de Vasos

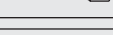

6260M		20 Pieces Set/△=15,800g	
METAL CASE:W580×H200×T85mm			
Sockets	Accessories		
<p> <b>6405M</b> 12-pt. Sockets 21, 23, 26, 29, 31, 32, 34, 35, 36, 38, 41, 46, 50</p> <p> <b>6101</b> Drag Link Socket</p>		<b>6749</b>	
		<b>6760-75</b>	
		<b>6760-200</b>	
		<b>6760-400</b>	
		<b>6770</b>	
		<b>6785</b>	

6260A		25 Pieces Set/△=19,000g	
METAL CASE:W580×H200×T85mm			
Sockets	Accessories		
<p> <b>6405A</b> 12-pt. Sockets 15/16, 31/32, 1, 1.1/16, 1.1/8, 1.3/16, 1.1/4, 1.5/16, 1.3/8, 1.7/16, 1.1/2, 1.9/16, 1.5/8, 1.11/16, 1.3/4, 1.13/16, 1.7/8, 2</p> <p> <b>6101</b> Drag Link Socket</p>		<b>6749</b>	
		<b>6760-75</b>	
		<b>6760-200</b>	
		<b>6760-400</b>	
		<b>6770</b>	
		<b>6785</b>	

## 6268M Socket Sets Juegos de Vasos

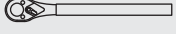
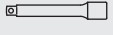
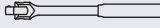

6268M		15 Pieces Set/△=12,500g	
METAL CASE:W580×H124×T70mm			
Sockets	Accessories		
<p> <b>6405M</b> 12-pt. Sockets 19, 22, 24, 27, 29, 30, 32, 36, 38, 41, 46, 50</p>		<b>6749</b>	
		<b>6760-200</b>	
		<b>6768</b>	

HAND  
MANUALES

Z-SERIES

TITANIUM  
DE TITANIO

ACCESSORIES  
ACCESORIOS

SCREWDRIVERS  
DESTORNILLADORES

IMPACT  
DE IMPACTO

SLEEVE-DRIVE

INDUSTRIAL  
INDUSTRIALES

AUTOMOTIVE

CONSTRUCTION  
CONSTRUCCION

RENEWAL KITS  
JUEGOS DE PIEZAS REPIESTO

## 8400M · 8400A 6-point Sockets Vasos Hexagonales

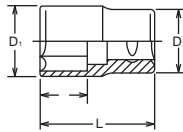

8400M 8405M (mm)	D <sub>1</sub> (mm)	D <sub>2</sub> (mm)	(mm)	L (mm)	(g)	(pce.)
24	36.5	44	17	60	360	1
27	40.5	44	19	60	362	1
30	44	45	21	65	410	1
32	46.5	45	23	65	455	1
33	48	46	23.5	65	485	1
35	50.5	48	24.5	65	536	1
36	51.5	48	25	65	600	1
38	54	50	26	65	624	1
40	56.5	53	27	65	686	1
41	58	53	28	68	747	1
42	59	53	28.5	68	789	1
46	64	53	31	72	928	1
50	69	53	34	72	943	1
54	74	55	37	72	1016	1
55	75.5	53	42	77	1167	1
58	79	53	41	77	1200	1
60	81.5	58	46	82	1440	1
63	85.5	58	45	82	1470	1
65	88	63	49	86	1683	1
67	90.5	63	49	86	1840	1
68	91.5	63	49	86	1800	1
70	94	68	50	88	1963	1
71	95.5	68	50	88	2200	1
75	100.5	73	53	90	2204	1
80	106.5	75	58	95	2550	1
83	110.5	78	57	95	2730	1
85	113	80	57	95	2680	1
90	119	80	59	100	3420	1
95	125.5	85	58	100	4900	1
100	131.5	85	57	100	4840	1

## 8405M · 8405A 12-point Sockets Vasos Bihexagonales

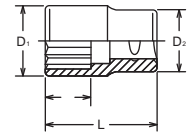

8400A 8405A (inch)	D <sub>1</sub> (mm)	D <sub>2</sub> (mm)	(mm)	L (mm)	(g)	(pce.)
15/16	36.5	44	17	60	355	1
1. 3/16	44	45	21	65	410	1
1. 1/4	46.5	45	23	65	455	1
1. 5/16	48	46	23.5	65	485	1
1. 3/8	50.5	48	24.5	65	536	1
1. 7/16	53	50	25.5	65	607	1
1. 1/2	54	50	26	65	624	1
1. 9/16	56.5	53	27	65	686	1
1. 5/8	58	53	28	68	747	1
1.11/16	60.5	53	29	68	830	1
1. 3/4	61.5	53	29.5	68	807	1
1.13/16	64	53	31	72	928	1
1. 7/8	66.5	53	32	72	936	1
1.15/16	68	53	32.5	72	941	1
2	70.5	53	37	72	976	1
2. 1/16	73	54	37	72	1027	1
2. 1/8	74	55	37	72	1016	1
2. 3/16	76.5	53	41	77	1192	1
2. 1/4	78	53	41	77	1177	1
2. 5/16	80.5	53	41	77	1292	1
2. 3/8	81.5	58	46	82	1440	1
2. 7/16	84	58	45	82	1495	1
2. 1/2	86.5	58	45	82	1497	1
2. 9/16	88	63	49	86	1683	1
2. 5/8	90.5	63	49	86	1840	1
2.11/16	91.5	63	49	86	1800	1
2. 3/4	94	68	50	88	1963	1
2.13/16	96.5	68	50	88	2035	1
2. 7/8	98	70	50	88	2100	1
2.15/16	100.5	73	53	90	2204	1
3	103	75	53	90	2406	1
3. 1/8	106.5	75	58	95	2550	1
3. 1/4	110.5	78	57	95	2730	1
3. 3/8	114	80	57	95	3050	1
3. 1/2	119	80	59	100	3420	1
3. 3/4	125.5	85	58	100	4900	1

8012M.80 (mm)	D (mm)	(mm)	L (mm)	(g)	(pcs.)
17	44.2	15.5	80	400	5
19	44.2	15.5	80	410	5
22	47.9	22.5	80	436	5
24	47.9	22.5	80	471	5
27	47.9	22.5	80	526	5
30	47.9	22.5	80	658	5
32	47.9	22.5	80	715	5
36	54.2	22.5	80	945	5

## 8012M-80 Inhex Sockets Vasos con Punta de Hexagonal

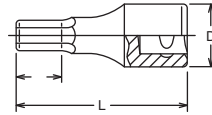

8760	D (mm)	L (mm)	(g)	(pcs.)
200	44	200	1300	1
400	44	400	2570	1

## 8760-200 · -400 Extension Bars Alargaderas

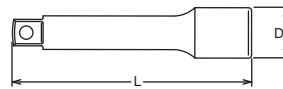

8770	L (mm)	(g)	(pcs.)
8770	143	1170	1

## 8770 Universal Joint Articulación Universal

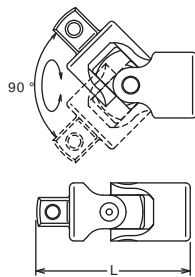

8866A	(mm)	(mm)	L (mm)	(g)	(pcs.)
8866A	1"	3/4"	60	338	5

 Adapting down from bigger square drive to smaller square drive may lead to excessive torque and possibly cause breakage.

La adaptación de mayor a menor de un cuadrado conductor puede conducir a un par excesivo que puede causar roturas.

## 8866A Adaptor Warranty 1850Nm Adaptador Garantía 1850Nm

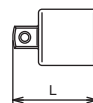

HAND  
MANUALES

Z-SERIES

TITANIUM  
DE TITANIO

ACCESSORIES  
ACCESORIOS

SCREWDRIVERS  
DESTORNILLADORES

IMPACT  
DE IMPACTO

SLEEVE-DRIVE

INDUSTRIAL  
INDUSTRIALES

AUTOMOTIVE

CONSTRUCTION  
CONSTRUCCION

RENEWAL KITS  
JUEGOS DE PIEZAS REPUESTO



# Hand Sockets 1”

HAND  
MANUALES

Z-SERIES

TITANIUM  
DE TITANIO

ACCESSORIES  
ACCESORIOS

SCREWDRIVERS  
DESTORNILLADORES

IMPACT  
DE IMPACTO

SLEEVE-DRIVE  
INDUSTRIALES

INDUSTRIAL  
INDUSTRIALES

AUTOMOTIVE

CONSTRUCTION  
CONSTRUCCION

RENEWAL KITS  
JUEGOS DE PIEZAS/REPLISTO

**8749** Reversible Ratchet  
Llave de Carraca Reversible

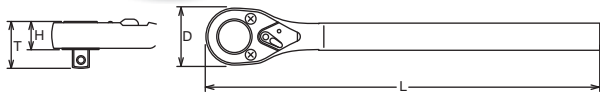

\* Renewal Kits → 8749RK → P277

	D (mm)	T (mm)	H (mm)	L (mm)	(g)	(pce.)
8749	70	62.2	36.2	800	4090	1

**8768** Hinge Handle  
Mango Articulado

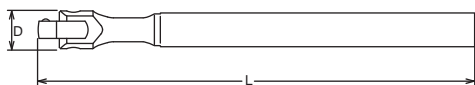

\* Renewal Kits → 8768RK → P278

	D (mm)	L (mm)	(g)	(pce.)
8768	55	600	3190	1

**8785** T-Handle  
Mango Corredizo

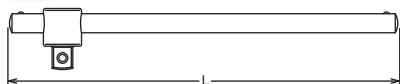

	L (mm)	(g)	(pce.)
8785	550	3190	1

**8788** L-Handle  
Mango Acodado



	L (mm)	(g)	(pce.)
8788	600	3600	1

# 1" Hand Sockets



HAND  
MANUALES

Z-SERIES

TITANIUM  
DE TITANIO

ACCESSORIES  
ACCESORIOS

SCREWDRIVERS  
DESTORNILLADORES

IMPACT  
DE IMPACTO

SLEEVE-DRIVE

INDUSTRIAL  
INDUSTRIALES

AUTOMOTIVE

CONSTRUCTION  
CONSTRUCCION

RENEWAL KITS  
JUEGOS DE PIEZAS REPUESTO

HAND  
MANUALES

Z-SERIES

TITANIUM  
DE TITANIO

ACCESSORIES  
ACCESORIOS

SCREWDRIVERS  
DESTORNILLADORES

IMPACT  
DE IMPACTO

SLEEVE-DRIVE

INDUSTRIAL  
INDUSTRIALES





AUTOMOTIVE





CONSTRUCTION  
CONSTRUCCION

RENEWAL KITS  
JUEGOS DE PIEZAS REPLÉSTO

## 8200M • 8200A Socket Sets Juegos de Vasos







8200M		12 Pieces Set/⚖️=18,600g	
METAL CASE:W600×H150×T110mm			
Sockets		Accessories	
 <b>8405M</b> 12-pt. Sockets 35, 38, 41, 46, 50, 54, 58, 63		<b>8760-200</b>	
		<b>8760-400</b>	
		<b>8770</b>	
		<b>8785</b>	

8200A		12 Pieces Set/⚖️=18,600g	
METAL CASE:W600×H150×T110mm			
Sockets		Accessories	
 <b>8405A</b> 12-pt. Sockets 1.7/16, 1.1/2, 1.5/8, 1.13/16, 2, 2.1/8, 2.1/4, 2.1/2		<b>8760-200</b>	
		<b>8760-400</b>	
		<b>8770</b>	
		<b>8785</b>	

## 8225M Socket Set Juego de Vasos

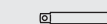

8225M		15 Pieces Set/⚖️=27,000g	
METAL CASE:W620×H217×T97mm			
Sockets		Accessories	
 <b>8405M</b> 12-pt. Sockets 32, 33, 36, 41, 46, 50, 55, 60, 65, 70, 75, 80		<b>8749</b>	
		<b>8760-200</b>	
		<b>8760-400</b>	

Sockets in sets can be supplied in 6-pt. or 12-pt. format.

# Z-series





HAND MANUALES  
Z-SERIES  
TITANIUM DE TITANIO  
ACCESSORIES ACCESORIOS  
SCREWDRIVERS DESTORNILLADORES  
IMPACT DE IMPACTO  
SLEEVE-DRIVE  
INDUSTRIAL INDUSTRIALES  
AUTOMOTIVE  
CONSTRUCTION CONSTRUCCION  
RENEWAL KITS JUEGOS DE PIEZAS REPLÉSTO

# Z-Series : Feature



## COMPACT

2400MZ and 3400MZ are designed 5-9mm shorter than standard 2400M and 3400M. Ideal for working in confined and tight areas.

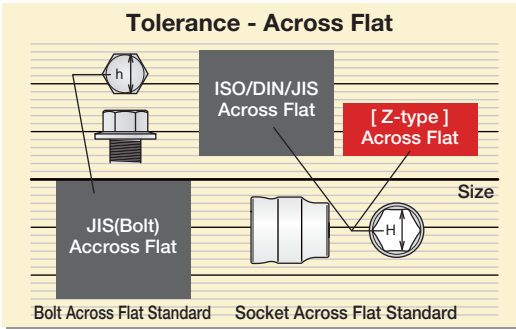

## TOLERANCE-Hexagon Opening

Ko-ken standard sockets are manufactured according to DIN/ISO standards. The tolerances of 2400MZ, 2300MZ, 3400MZ and 3300MZ sockets are precisely controlled to achieve a more positive fit between bolt and socket.

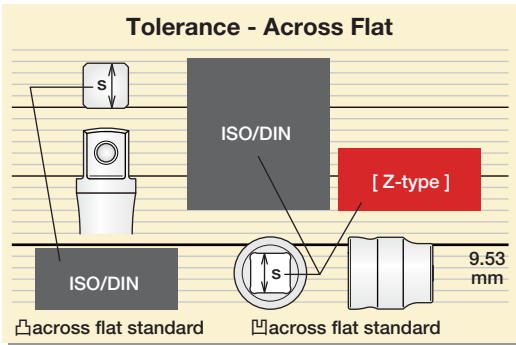

## TOLERANCE-Square Drive

Manufacturing tolerance of Male and Female Square are precisely controlled to achieve a more secure fit between Socket and Handle.

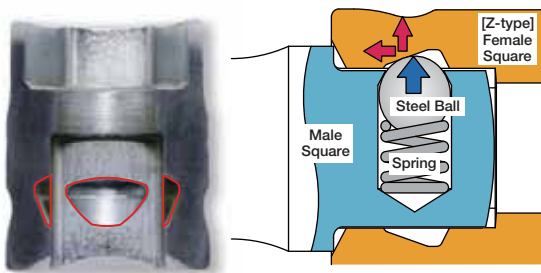

## BALL HOLDING GROOVE

Original Ball Holding system is applied on Z-series. This mechanism gives secure connection between Socket and Handle.

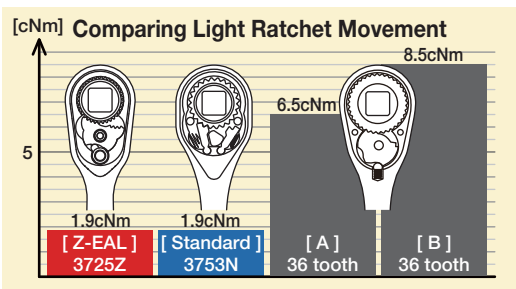

## RATCHET HANDLE

Smaller head with 36 tooth gear and light ratchet movement allow working in narrow space and confined areas.

\* A, B : Other Brand



	2400MZ (mm)	D <sub>1</sub> (mm)	D <sub>2</sub> (mm)	(mm)	L (mm)	(g)	(pcs.)
New	4	6.4	11	3	14	6	10
New	4.5	7	11	3	14	6	10
New	5	7.6	11	3	14	6	10
New	5.5	8.2	11	3.5	14	6	10
New	6	8.8	11	3.5	14	6	10
New	7	9.9	11	3.5	14	6	10
New	8	11.1	11.7	4.5	15	7	10
New	10	13.5	12.5	7	15	8	10
New	11	14.7	13.2	7	15	9	10
New	12	15.9	14.4	7	15	11	10
New	13	17.1	15.6	7	15	14	10
New	14	18.3	16.8	7	15	16	10

	RS2400MZ/12	12 Pieces Set/Rail 200mm	(g)
New	4, 4.5, 5, 5.5, 6, 7, 8, 10, 11, 12, 13, 14		228

	2300MZ	D <sub>1</sub> (mm)	D <sub>2</sub> (mm)	(mm)	L (mm)	(g)	(pcs.)
New	4	6.4	11	5	50	14	10
New	4.5	7	11	5.5	50	16	10
New	5	7.6	11	6	50	16	10
New	5.5	8.2	11	6.5	50	16	10
New	6	8.8	11	7	50	17	10
New	7	9.9	11	8	50	20	10
New	8	11.1	11.7	9	50	22	10
New	10	13.5	12.5	11	50	29	10
New	11	14.7	13.2	12	50	33	10
New	12	15.9	14.4	13	50	40	10
New	13	17.1	15.6	14	50	45	10
New	14	18.3	16.8	16	50	51	10

	RS2300MZ/12	12 Pieces Set/Rail 200mm	(g)
New	4, 4.5, 5, 5.5, 6, 7, 8, 10, 11, 12, 13, 14		445

## 2400MZ 6-point Sockets Vasos Hexagonales



## RS2400MZ/12 Socket Set on Rail Juego de Vasos en Regleta



## 2300MZ 6-point Deep Sockets Vasos Hexagonales Largos

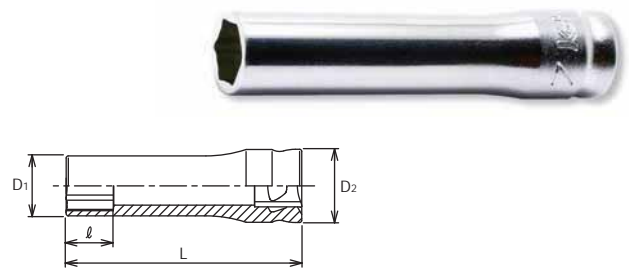

## RS2300MZ/12 Socket Set on Rail Juego de Vasos en Regleta



HAND MANUALES  
Z-SERIES  
TITANIUM DE TITANIO  
ACCESSORIES ACCESORIOS  
SCREWDRIVERS DESTORNILLADORES  
IMPACT DE IMPACTO  
SLEEVE-DRIVE INDUSTRIAL INDUSTRIALES  
AUTOMOTIVE  
CONSTRUCTION CONSTRUCCION  
RENEWAL KITS JUEGOS DE PIZAS REPUESTO

# Z-series 1/4"

HAND  
MANUALES

Z-SERIES

TITANIUM  
DE TITANIO

ACCESSORIES  
ACCESORIOS

SCREWDRIVERS  
DESTORNILLADORES

IMPACT  
DE IMPACTO

SLEEVE-DRIVE

INDUSTRIAL  
INDUSTRIALES



AUTOMOTIVE

CONSTRUCTION  
CONSTRUCCIÓN

RENEWAL KITS  
JUEGOS DE PIEZAS REPLISTO

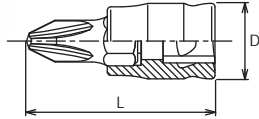

## 2000Z-28 Phillips Bit Sockets Vasos con Punta Phillips



	2000Z.28 (PH)	D (mm)	L (mm)	 (g)	 (pcs.)
New	1	11.2	28	9	10
New	2	11.2	28	10	10
New	3	11.2	28	10	10

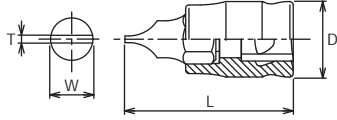

## 2005Z-25 Slotted Bit Sockets Vasos con Punta Recta para Cabeza Ranurada

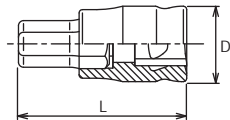

	2005Z.25	T x W (mm)	D (mm)	L (mm)	 (g)	 (pcs.)
New	5	1.0 x 5.5	11.2	25	9	10
New	6	1.2 x 6.5	11.2	25	10	10

## 2010MZ-25 Inhex Bit Sockets Vasos con Punta Hexagonal



	2010MZ.25 (mm)	D (mm)	L (mm)	 (g)	 (pcs.)
New	3	11.2	25	9	10
New	4	11.2	25	9	10
New	5	11.2	25	10	10
New	6	11.2	25	10	10



## RS20XXZ/9 Socket Set on Rail Juego de Vasos en Regleta

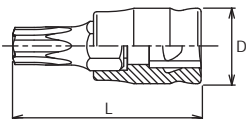

RS20XXZ/9		9 Pieces Set/Rail 200mm	 (g)
New	2000Z.28	1, 2, 3	213
New	2005Z.25	5, 6	
New	2010MZ.25	3, 4, 5, 6	

## 2025Z-28 TORX® Bit Sockets Vasos con Punta TORX®



	2025Z.28 (T)	D (mm)	L (mm)	 (g)	 (pcs.)
New	T10	11.2	28	9	10
New	T15	11.2	28	9	10
New	T20	11.2	28	9	10
New	T25	11.2	28	10	10
New	T27	11.2	28	10	10
New	T30	11.2	28	10	10
New	T40	11.2	28	11	10

## RS2025Z/7-L28 Socket Set on Rail Juego de Vasos en Regleta



RS2025Z/7-L28		7 Pieces Set/Rail 200mm	 (g)
New	T10, T15, T20, T25, T27, T30, T40		195

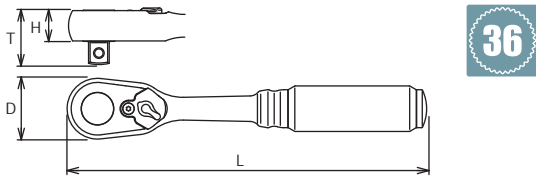

**36**

**2725Z** Reversible Ratchet  
Llave de Carraca Reversible



	D (mm)	T (mm)	H (mm)	L (mm)	(g)	(pce.)
<b>2725Z</b>	20.5	17.1	9.5	114	79	1

\* Renewal Kits → 2725RK → P276

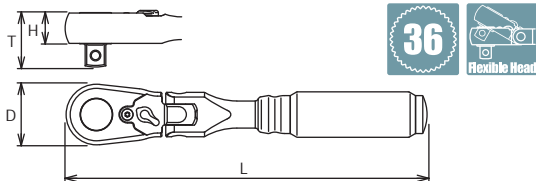

**36**  
Flexible Head

**2726Z** Flexible Ratchet, Reversible (Short)  
Llave de Carraca Flexible, Reversible (Corta)



	D (mm)	T (mm)	H (mm)	L (mm)	(g)	(pce.)
<b>2726Z</b>	20.5	17.1	9.5	114	103	1

\* Renewal Kits → 2725RK → P276

	D (mm)	L (mm)	(g)	(pcs.)
<b>2760Z</b>				
<b>50</b>	11.5	50	21	10
<b>100</b>	11.5	100	39	10
<b>150</b>	11.5	150	58	10

**2760Z** Extension Bars  
Alargaderas

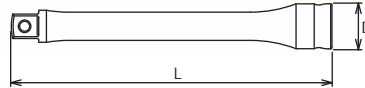

	D (mm)	L (mm)	(g)	(pcs.)
<b>2771Z</b>	11.7	29.9	15	10

**2771Z** Universal Joint  
Articulación Universal

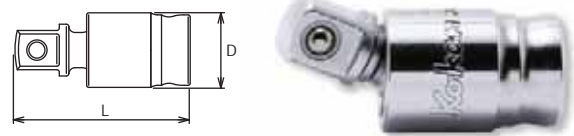

**2756Z** Quick Spinner  
Disco de Giro Rápido

**2756Z-3/8**



**2756Z-3/8**

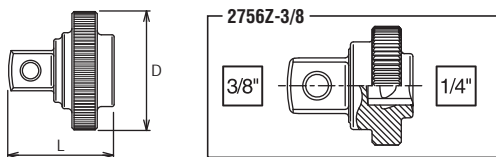

	D (mm)	L (mm)	(g)	(pcs.)
<b>2756Z</b>	20.3	18	15	10
<b>2756Z-3/8</b>	20.3	21.5	24	10

**P2285Z** 26 Pieces Set / 660g  
PLASTIC CASE: W245xH120xT45

Sockets	Accessories
<b>2400MZ</b> 6-pt. Sockets 4, 4.5, 5, 5.5, 6, 7, 8, 10, 11, 12, 13, 14	<b>2725Z</b>
<b>2000Z.28</b> 1, 2, 3	<b>2756Z</b>
<b>2005Z.25</b> 5, 6	<b>2771Z</b>
<b>2010MZ.25</b> 3, 4, 5, 6	<b>2760Z-50</b>
	<b>2760Z-150</b>

**P2285Z** Socket Set  
Juego de Vasos



**2285ZE** 10 Pieces Set / 300g  
Rail 200mm/PLASTIC BAG

Sockets	Accessories
<b>2400MZ</b> 6-pt. Sockets 5.5, 6, 7, 8, 10, 12, 13, 14	<b>2725Z</b>
	<b>2756Z</b>

**2285ZE**



# Z-series 3/8"

HAND  
MANUALES

Z-SERIES

TITANIUM  
DE TITANIO

ACCESSORIES  
ACCESORIOS

SCREWDRIVERS  
DESTORNILLADORES

IMPACT  
DE IMPACTO

SLEEVE-DRIVE

INDUSTRIAL  
INDUSTRIALES

AUTOMOTIVE

CONSTRUCTION  
CONSTRUCCION

RENEWAL KITS  
JUEGOS DE PIEZAS REPLISTO

## 3400MZ 6-point Sockets Vasos Hexagonales



3400MZ (mm)	D <sub>1</sub> (mm)	D <sub>2</sub> (mm)	(mm)	L (mm)	(g)	(pcs.)
5.5	8.5	17	3.5	19	16	10
6	9.1	17	3.5	19	17	10
7	10.3	17	3.5	19	17	10
8	11.5	17	4.5	20	17	10
10	14	17	4.5	20	18	10
11	15.3	17	5.5	21	18	10
12	16.5	17	5.5	21	19	10
13	17.8	17	8.5	21	19	10
14	19	17	8.5	21	20	10
15	20.2	18.2	8.5	21	24	10
16	21.3	19.3	8.5	21	28	10
17	22.5	20.5	8.5	21	32	10
18	23.6	21.6	9.5	22	38	10
19	24.8	22.8	9.5	22	41	10
21	27	25	10.5	23	51	10
22	28.3	26.3	10.5	23	58	10

3400MZ is designed 5-9mm shorter than standard 3400M.  
Ideal for working in confined and tight areas.

## RS3400MZ/8 Socket Set on Rail Juego de Vasos en Regleta

### RS3400MZ/12



RS3400MZ/8	8 Pieces Set/Rail 200mm	(g)
8, 10, 11, 12, 13, 14, 17, 19		320

RS3400MZ/12	12 Pieces Set/Rail 300mm	(g)
7, 8, 10, 11, 12, 13, 14, 15, 16, 17, 18, 19		490

## 3300MZ 6-point Deep Sockets Vasos Hexagonales Largos

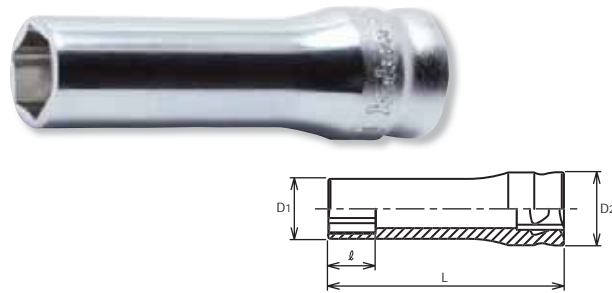

3300MZ (mm)	D <sub>1</sub> (mm)	D <sub>2</sub> (mm)	(mm)	L (mm)	(g)	(pcs.)
7	10.3	17	8	55	29	10
8	11.5	17	9	55	34	10
10	14	17	11	55	43	10
11	15.3	17	12	55	45	10
12	16.5	17	13	55	49	10
13	17.8	17	14	55	52	10
14	19	17	16	55	55	10
15	20.2	18.2	16	55	65	10
16	21.3	19.3	17	55	74	10
17	22.5	20.5	18	55	83	10
18	23.6	21.6	19	55	90	10
19	24.8	22.8	20	55	95	10

## RS3300MZ/8 Socket Set on Rail Juego de Vasos en Regleta

### RS3300MZ/12



RS3300MZ/8	8 Pieces Set/Rail 200mm	(g)
8, 10, 11, 12, 13, 14, 17, 19		600

RS3300MZ/12	12 Pieces Set/Rail 300mm	(g)
7, 8, 10, 11, 12, 13, 14, 15, 16, 17, 18, 19		900

## RS3X00MZ/12 Socket Set on Rail Juego de Vasos en Regleta



RS3X00MZ/12	12 Pieces Set/Rail 300mm	(g)
3400MZ	8, 10, 11, 12, 13, 14, 17, 19	550
3300MZ	8, 10, 12, 14	

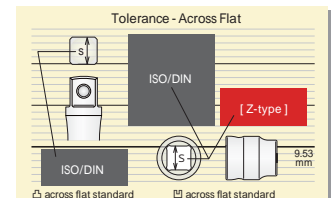
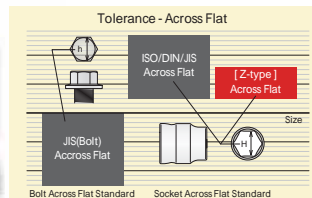

Manufacturing tolerance is precisely controlled to achieve a secure fitting.

3300CZ (mm)	D (mm)	(mm)	L (mm)	(g)	(pcs.)
14	18.4	11	70	67	10
16	20.5	13	70	71	10
18	22.9	12	70	75	10
20.8	26.3	13.5	70	105	10

Slim & light weight body with smaller outside diameter for work in tight spaces.

### 3300CZ Spark Plug Sockets with Spring Clips Llaves de Bujía con Presillas

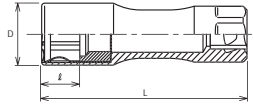

3010MZ.50 (mm)	D (mm)	L (mm)	(g)	(pcs.)
3	17	50	28	10
4	17	50	29	10
5	17	50	30	10
6	17	50	35	10
7	17	50	38	10
8	17	50	40	10
10	17	50	50	10
12	19	50	70	10

### 3010MZ-50 Inhex Bit Sockets Vasos con Punta Hexagonal

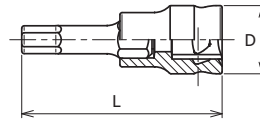

RS3010MZ/8-L50	8 Pieces Set/Rail 200mm	(g)
3, 4, 5, 6, 7, 8, 10, 12		460

### RS3010MZ/8-L50 Socket Set on Rail Juego de Vasos en Regleta



3025Z.50 (T)	D (mm)	L (mm)	(g)	(pcs.)
T10	17	50	27	10
T15	17	50	28	10
T20	17	50	28	10
T25	17	50	29	10
T27	17	50	30	10
T30	17	50	31	10
T40	17	50	35	10
T45	17	50	38	10
T50	17	50	48	10
T55	19	50	70	10

### 3025Z-50 TORX® Bit Sockets Vasos con Punta TORX®

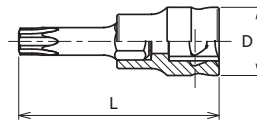

RS3025Z/8-L50	8 Pieces Set/Rail 200mm	(g)
T20, T25, T27, T30, T40, T45, T50, T55		450

### RS3025Z/8-L50 Socket Set on Rail Juego de Vasos en Regleta

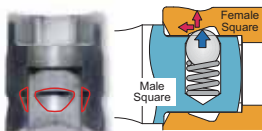

### BALL HOLDING GROOVE

Original Ball Holding system is applied on Z-series. This mechanism gives secure connection between Socket and Handle.



# Z-series 3/8"

HAND  
MANUALES

Z-SERIES

TITANIUM  
DE TITANIO

ACCESSORIES  
ACCESORIOS

SCREWDRIVERS  
DESTORNILLADORES

IMPACT  
DE IMPACTO

SLEEVE-DRIVE

INDUSTRIAL  
INDUSTRIALES

AUTOMOTIVE

CONSTRUCTION  
CONSTRUCCION

RENEWAL KITS  
JUEGOS DE PIEZAS REPLÉSTO

**2725Z-3/8** Reversible Ratchet Short  
Llave de Carraca Reversible Corta



36

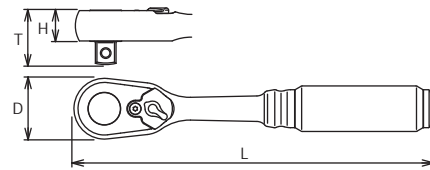

	D (mm)	T (mm)	H (mm)	L (mm)	(g)	(pce.)
<b>2725Z-3/8</b>	20.5	20.5	9.5	114	83	1

**3725ZS** Reversible Ratchet Short  
Llave de Carraca Reversible Corta



36

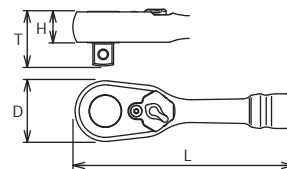

	D (mm)	T (mm)	H (mm)	L (mm)	(g)	(pce.)
<b>3725ZS</b>	28	24.5	13.7	100	157	1

\* Renewal Kits → 3725RK → P276

**3725Z** Reversible Ratchet  
Llave de Carraca Reversible



36

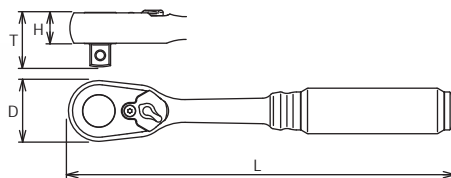

	D (mm)	T (mm)	H (mm)	L (mm)	(g)	(pce.)
<b>3725Z</b>	28	24.5	13.7	178	254	1

\* Renewal Kits → 3725RK → P276

**2726Z-3/8** Flexible Ratchet, Reversible (Short)  
Llave de Carraca Flexible, Reversible (Corta)



36

Flexible Head

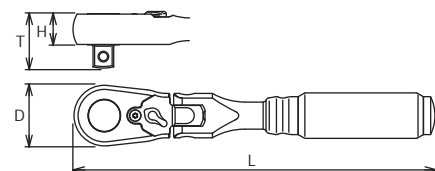

	D (mm)	T (mm)	H (mm)	L (mm)	(g)	(pce.)
<b>2726Z-3/8</b>	20.5	20.5	9.5	114	107	1

**3726ZS** Flexible Ratchet, Reversible (Short)  
Llave de Carraca Flexible, Reversible (Corta)



36

Flexible Head

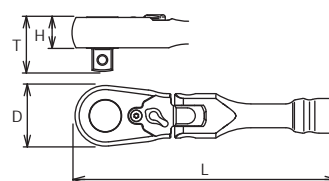

	D (mm)	T (mm)	H (mm)	L (mm)	(g)	(pce.)
<b>3726ZS</b>	28	24.5	13.7	120	196	1

\* Renewal Kits → 3725RK → P276

**3726Z** Flexible Ratchet, Reversible  
Llave de Carraca Flexible, Reversible



36

Flexible Head

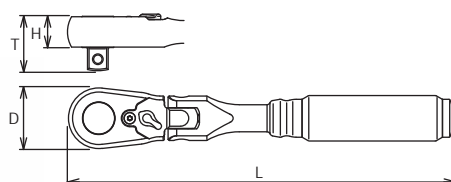

	D (mm)	T (mm)	H (mm)	L (mm)	(g)	(pce.)
<b>3726Z</b>	28	24.5	13.7	178	317	1

\* Renewal Kits → 3725RK → P276



### 3768Z-250 Hinge Handle Mango Articulado



	D (mm)	L (mm)	(g)	(pcs.)
<b>3768Z-250</b>	20.5	250	309	1

\* Renewal Kits → **3768ZRK** → P278

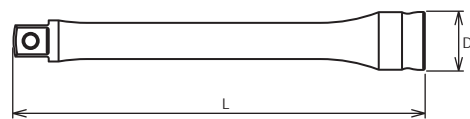
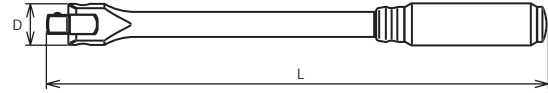

3760Z	D (mm)	L (mm)	(g)	(pcs.)
<b>75</b>	17.5	75	66	10
<b>125</b>	17.5	125	103	10
<b>250</b>	17.5	250	195	5

### 3760Z-75 • -125 • -250 Extension Bars Alargaderas



	D (mm)	L (mm)	(g)	(pcs.)
<b>3771Z</b>	18	42.5	44	10

### 3771Z Universal Joint Articulación Universal

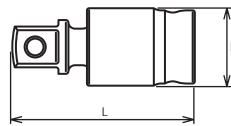
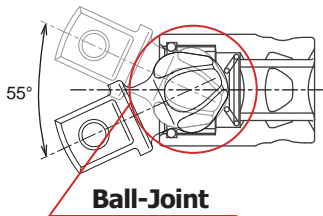

	D (mm)	L (mm)	(g)	(pcs.)
<b>3756Z</b>	28	25	40	10

Outside diameter is smaller compared to standard 3756.  
Ideal for working in combination with 3725Z

### 3756Z Quick Spinner Disco de Giro Rápido

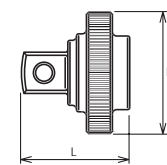

	D (mm)	L (mm)	(g)	(pcs.)
<b>3322AZ-75</b>	17.5	75	42	10

### 3322AZ-75 Extension Adaptor Adaptador Alargadera

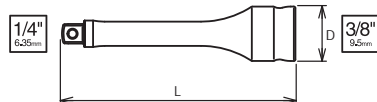
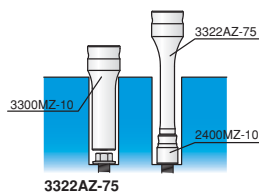

HAND MANUALES  
Z-SERIES  
TITANIUM DE TITANIO  
ACCESSORIES ACCESORIOS  
SCREWDRIVERS DESTORNILLADORES  
IMPACT DE IMPACTO  
SLEEVE-DRIVE  
INDUSTRIAL INDUSTRIALES  
AUTOMOTIVE  
CONSTRUCTION CONSTRUCCION  
RENEWAL KITS JUEGOS DE PIEZAS REPUESTO

HAND MANUALES  
Z-SERIES  
TITANIUM DE TITANIO  
ACCESSORIES ACCESORIOS  
SCREWDRIVERS DESTORNILLADORES  
IMPACT DE IMPACTO  
SLEEVE-DRIVE  
INDUSTRIAL INDUSTRIALES  
AUTOMOTIVE  
CONSTRUCTION CONSTRUCCION  
RENEWAL KITS JUEGOS DE PIEZAS REPLETO

**3285Z** Socket Set  
Juego de Vasos



3285Z		26 Pieces Set/△=2,100g		
PLASTIC TRAY:W390xT180xH25				
Sockets		Accessories		
○	<b>3400MZ</b> 6-pt. Sockets 5.5, 6, 7, 8, 10, 12, 13, 14, 17, 19, 21, 22		<b>3725Z</b>	
	○	<b>3300MZ</b> 6-pt. Deep Sockets 8, 10, 12, 14		<b>3756Z</b>
		<b>3300CZ</b> Spark Plug Sockets 14, 16, 20.8		<b>3771Z</b>
			<b>3768Z-250</b>	
			<b>3760Z-75</b>	
			<b>3760Z-125</b>	
			<b>3760Z-250</b>	

**3285ZA** Socket Set  
Juego de Vasos



3285ZA		15 Pieces Set/△=750g	
PLASTIC TRAY:W300xT90xH25			
Sockets		Accessories	
○	<b>3400MZ</b> 6-pt. Sockets 5.5, 6, 7, 8, 10, 12, 13, 14, 17, 19, 21, 22		<b>3725Z</b>
			<b>3756Z</b>
			<b>3771Z</b>

**3285ZE** Socket Set  
Juego de Vasos



3285ZE		9 Pieces Set/△=600g	
Rail 200mm/PLASTIC BAG			
Sockets		Accessories	
○	<b>3400MZ</b> 6-pt. Sockets 8, 10, 12, 13, 14, 17, 19		<b>3725Z</b>
			<b>3756Z</b>

**RSAL200-1/4x12 · -3/8x8** Rail  
**RSAL300-3/8x12 · -1/2x10** Regleta



	RSAL200		RAIL (mm)	CLIP (pcs.)	(g)	(pce.)
New	1/4x12	1/4"	200	12	125	1
	3/8x8	3/8"	200	8	130	1
	RSAL300		RAIL (mm)	CLIP (pcs.)	(g)	(pce.)
New	3/8x12	3/8"	300	12	180	1
	1/2x10	1/2"	300	10	190	1



**RSAL-200 · -300**  
**CLIP.P/5-1/4 · -3/8 · -1/2**



RAIL			
	RAIL (mm)	(g)	(pce.)
New	RSAL200	200	110
New	RSAL300	300	145
			1
CLIP			
	CLIP.P/5	(g)	(pce.)
New	1/4	1/4"	10
New	3/8	3/8"	13
New	1/2	1/2"	20
			5
			5
			5

# Titanium Sockets











HAND MANUALES  
Z-SERIES  
TITANIUM DE TITANIO  
ACCESSORIES ACCESORIOS  
SCREWDRIVERS DESTORNILLADORES  
IMPACT DE IMPACTO  
SLEEVE-DRIVE  
INDUSTRIAL INDUSTRIALES  
AUTOMOTIVE  
CONSTRUCTION CONSTRUCCION  
RENEWAL KITS JUEGOS DE PIEZAS REPLUESTO

**TI4261M** Socket Set Titanium  
Juego de Vasos de Titanio



<b>TI4261M</b>		18 Pieces Set/△=4,280g	
WOODEN CASE:W445xH190xT60mm			
Sockets		Accessories	
	<b>TI4400M</b> 6-pt. Sockets 8, 10, 11, 12, 13, 14, 17, 19, 21, 22, 24, 26, 27		<b>TI4749J</b>
			<b>TI4760-125</b>
			<b>TI4760-250</b>
			<b>TI4768J-380</b>
			<b>TI4770</b>

**Characteristic of Titanium**

- Light weight** : Makes it effective for operating tools. The specific gravity is only about 58% of chrome molybdenum steel which is used for our normal products.
- Non-Corrosion** : Corrosion Resistance is greatly improved against salt water and any kind of chemical products.
- Non-Magnetic** : Non-Magnetic material will prevent the tools from magnetizing.

**Características del Titanio**

- Peso ligero** : Aumenta la eficiencia de las herramientas de trabajo. El peso específico es aproximadamente sólo el 58% del acero al cromo-molibdeno de nuestros productos normales.
- No se oxida** : Se aumenta significativamente la resistencia a la corrosión por ambiente salino o por cualquier clase de productos químicos.
- No es magnético** : Material paramagnético que evita la magnetización de las herramientas.

Pentagonal drive is designed to avoid using with normal square drive items, so that it will provide extra safety and much more strength.

El diseño de conductor pentagonal evita su utilización con conductores normales cuadrados, proporcionando más seguridad y mucha mayor resistencia.





# Accessories





HAND MANUALES  
Z-SERIES  
TITANIUM DE TITANIO  
ACCESSORIES ACCESORIOS  
SCREWDRIVERS DESTORNILLADORES  
IMPACT DE IMPACTO  
SLEEVE-DRIVE  
INDUSTRIAL INDUSTRIALES  
AUTOMOTIVE  
CONSTRUCTION CONSTRUCCION  
RENEWAL KITS JUEGOS DE PIEZAS REPLUESTO

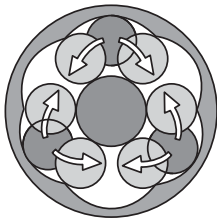
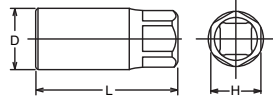

**4100M • 4100A**  Screw and Stud Pullers  
Extractores de Espárragos y Tornillos



**Screw and Stud Pullers**  
Hexagon body design can lessen the excessive load on cages and rollers inside the pullers.

**Extractores de Tornillos y Espárragos**  
El diseño hexagonal del cuerpo evita cargas excesivas en las celdas y rodillos internos del extractor.

4100M (mm)		D (mm)	L (mm)	H (mm)	(g)	(pcs.)
5	1/2"	24	65	21	145	10
6		24	65	21	150	10
7		24	65	21	150	10
8		24	65	21	147	10
9		28	75	21	217	10
10		28	75	21	213	10
10.5		28	75	21	202	10
11		28	75	21	218	10
12		28	75	21	220	10
14		34	75	27	340	5
16	- 	34	75	27	315	5

4100A (inch)		D (mm)	L (mm)	H (mm)	(g)	(pcs.)
1/4	1/2"	24	65	21	150	10
5/16		24	65	21	147	10
3/8		28	75	21	213	10
7/16		28	75	21	218	10
1/2		28	75	21	191	10
9/16		34	75	27	340	5
5/8	- 	34	75	27	315	5

\* Renewal Kits → **4100RK** → **P279**

 4100M-16 and 4100A-5/8 do not have 1/2" square drive.  
Drive the outer hexagon part with 27mm sockets or ring wrenches.  
4100M-16 y 4100A-5/8 no tienen conductores cuadrados de 1/2"  
Apretar la parte hexagonal exterior con vasos de 27mm o llaves de tuerca.

Tolerance/Tolerancia

4100M (mm)	4100A (inch)
5	1/4
6	5/16
7	3/8
8	7/16
9	1/2
10	9/16
10.5	5/8
11	10.4-11
12	11.4-12
14	13.2-14
16	15.2-16

**4211M • 4211A**  Screw and Stud Pullers Sets  
Juegos de Extractores de Tornillos y Espárragos



**4211M** 4 Pieces Set/  $\Delta$  = 1,040g  
METAL CASE: W215xH80xT47mm  
PULLER  
 **4100M** Stud Pullers  
6, 8, 10, 12

**4211A** 4 Pieces Set/  $\Delta$  = 1,040g  
METAL CASE: W215xH80xT47mm  
PULLER  
 **4100A** Stud Pullers  
1/4, 5/16, 3/8, 1/2

**4214M**  Screw and Stud Pullers Set  
Juegos de Extractores de Tornillos y Espárragos



**4214M** 5 Pieces Set/  $\Delta$  = 1,450g  
METAL CASE: W215xH80xT47mm  
PULLER  
 **4100M** Stud Pullers  
6, 8, 10, 12, 14

6100M (mm)		D (mm)	L (mm)	H (mm)	(g)	(pcs.)
18	3/4"	48	100	36	840	1
20		48	100	36	816	1
22		48	100	36	745	1
24		48	100	36	739	1
27		63	125	46	1707	1
28		63	125	46	1701	1
29		63	125	46	1696	1
30		63	125	46	1691	1

\* Renewal Kits → 6100RK → P279

6100M-22 to -30 do not have 3/4" square drive.  
Drive the outer hexagon part with sockets or ring wrenches (size 22-24mm = 36H, 27-30mm = 46H).

6100M-22-30 no tienen conductores cuadrados de 3/4"  
Apretar la parte hexagonal exterior con vasos o llaves de tuerca (medidas 22-24mm = 36H, 27-30mm = 46H)

### 6100M Screw and Stud Pullers Extractores de Tornillos y Espárragos

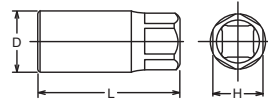

Tolerance/Tolerancia

6100M (mm)	
18	16.9-18
20	18.8-20
22	20.8-22
24	22.7-24
27	25.7-27
28	26.7-28
29	27.6-29
30	28.6-30

14100M (mm)		D <sub>1</sub> (mm)	D <sub>2</sub> (mm)	L (mm)	(g)	(pcs.)	
6	1/2"	24	25	48	126	10	*1
7		24	25	48	126	10	*1
8		24	25	48	122	10	*1
9		28	30	48	181	10	*2
10		28	30	48	181	10	*2
12		28	30	48	175	10	*2

14100A (inch)		D <sub>1</sub> (mm)	D <sub>2</sub> (mm)	L (mm)	(g)	(pcs.)	
1/4	1/2"	24	25	48	126	10	*1
5/16		24	25	48	122	10	*1
3/8		28	30	48	181	10	*2
7/16		28	30	48	181	10	*2
1/2		28	30	48	180	10	*2

\*1 C-Ring=1401C, Pin/O-Ring=1401A/B  
\*2 C-Ring=1402C, Pin/O-Ring=1402A/B

→ P232-233

Tolerance/Tolerancia

14100M (mm)		14100A (inch)	
6	5.6- 6	1/4	6 - 6.4
7	6.6- 7	5/16	7.6- 8
8	7.6- 8	3/8	9 - 9.6
9	8.4- 9	7/16	10.5-11.1
10	9.4-10	1/2	12.1-12.7
12	11.4-12		

### 14100M • 14100A IMPACT Screw and Stud Pullers Extractores de Tornillos y Espárragos de IMPACTO

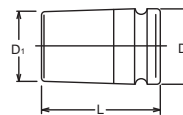

HAND MANUALES  
Z-SERIES  
TITANIUM DE TITANIO  
ACCESSORIES ACCESORIOS  
SCREWDRIVERS DESTORNILLADORES  
IMPACT DE IMPACTO  
SLEEVE-DRIVE INDUSTRIAL INDUSTRIALES  
AUTOMOTIVE  
CONSTRUCTION CONSTRUCCION  
RENEWAL KITS JUEGOS DE PIEZAS REPUESTO

# Stud Puller & Setter

HAND MANUALES  
Z-SERIES  
TITANIUM DE TITANIO  
ACCESSORIES ACCESORIOS  
SCREWDRIVERS DESTORNILLADORES  
IMPACT DE IMPACTO  
SLEEVE-DRIVE  
INDUSTRIAL INDUSTRIALES  
AUTOMOTIVE  
CONSTRUCTION CONSTRUCCION  
RENEWAL KITS JUEGOS DE PIEZAS REPLÉSTO

## 141S Stud Puller Ratchets Extractores de Espárragos de Carraca



141S (mm)	D (mm)	L (mm)	(g)	(pce.)
6	28	120	150	1
8	28	120	150	1
10	32	120	153	1
12	32	120	152	1

141S (inch)	D (mm)	L (mm)	(g)	(pce.)
5/16	28	120	150	1
3/8	32	120	153	1
1/2	32	120	152	1

## 141 Stud Puller Ratchets Extractores de Espárragos de Carraca



141 (mm)	D (mm)	L (mm)	(g)	(pce.)
6	28	205	215	1
8	28	205	215	1
10	32	205	234	1
12	32	205	233	1

141 (inch)	D (mm)	L (mm)	(g)	(pce.)
5/16	28	205	215	1
3/8	32	205	234	1
1/2	32	205	233	1

## 141P Stud Puller Ratchets Extractores de Espárragos de Carraca

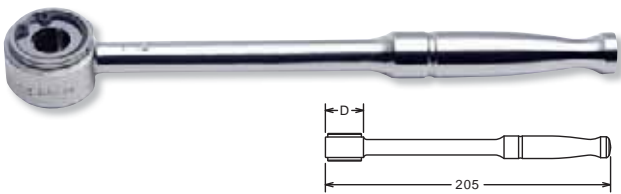

141P (mm)	D (mm)	L (mm)	(g)	(pce.)
6	28	205	210	1
8	28	205	210	1
10	32	205	229	1
12	32	205	227	1

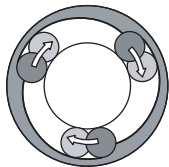

The three roller system can protect the studs from damage.

El sistema de tres rodillos puede proteger los espárragos de cualquier daño.



## 1201 Stud Puller Ratchets Set Juego de Extractores de Espárragos de Carraca



1201	4 Pieces Set/973g
METAL CASE:W240xH100xT32mm	
PULLER	
141S Stud Puller Ratchet 6, 8, 10, 12	

## 4104 Screw and Stud Puller Extractor de Tornillos y Espárragos



4104	1/2	Tolerance		D (mm)	L (mm)	(g)	(pce.)
		min	max				
		6	19	54	56	489	2

4103M (mm)		D <sub>1</sub> (mm)	D <sub>2</sub> (mm)	(mm)	L (mm)	(g)	(pcs.)
6(1.0)	1/2"	10.3	22	10	37	54	10
7(1.0)		11.5	22	10.6	37	58	10
8(1.25)		13.2	22	11.5	37	60	10
10(1.25)		15.3	23	13.5	44	86	10
10(1.5)		15.3	23	13.5	44	86	10
12(1.25)		17.8	23	15.5	44	86	10
12(1.75)		17.8	23	15.5	44	86	10

**4103M** Stud Bolt Setters  
Vasos para apretar pernos

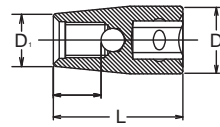

**4203M** 4 Pieces Set/ =530g  
METAL CASE:W130xH65xT26mm  
Stud Bolt Setter  
 **4103M** Stud Bolt Setters  
6(1.0), 8(1.25), 10(1.5), 12(1.75)

**4203MF** 4 Pieces Set/ =530g  
METAL CASE:W130xH65xT26mm  
Stud Bolt Setter  
 **4103M** Stud Bolt Setters  
6(1.0), 8(1.25), 10(1.25), 12(1.25)

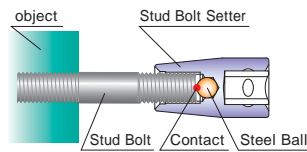

A special socket for installing a stud bolt.  
Inside steel ball prevent the stud bolt stuck onto the socket. After installing a stud bolt, turn to anti-clockwise to removing the socket.

**4203M** Stud Bolt Setters Set  
**4203MF** Juego de Vasos para apretar Pernos



13103M (mm)		D <sub>1</sub> (mm)	D <sub>2</sub> (mm)	(mm)	L (mm)	(g)	(pcs.)	
5(0.8)	3/8"	9.5	19	9	32	39	10	*1
6(1.0)		10.8	19	10	32	41	10	*1
7(1.0)		12.5	19	11	32	44	10	*1
8(1.25)		13.5	19	10.5	35	49	10	*1
10(1.25)		15.8	19	13.5	35	49	10	*1
10(1.5)		15.8	19	13.5	35	49	10	*1

\*1 C-Ring=1301C, Pin/O-Ring=1301A/B P232-233

**13103M** Impact Stud Bolt Setters  
Vasos para apretar Pernos de Impacto

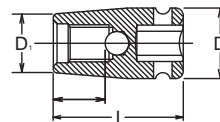

14103M (mm)		D <sub>1</sub> (mm)	D <sub>2</sub> (mm)	(mm)	L (mm)	(g)	(pcs.)	
6(1.0)	1/2"	12	25	10	38	75	10	*1
7(1.0)		13.2	25	11	38	78	10	*1
8(1.25)		14.5	25	11.5	38	81	10	*1
10(1.25)		17	25	13.5	44	106	10	*1
10(1.5)		17	25	13.5	44	106	10	*1
12(1.25)		19.5	25	15.5	44	107	10	*1
12(1.75)		19.5	25	15.5	44	107	10	*1
14(1.5)		22	25	18.2	44	128	10	*1
14(2.0)		22	25	18.2	44	128	10	*1

\*1 C-Ring=1401C, Pin/O-Ring=1401A/B P232-233

**14103M** Impact Stud Bolt Setters  
Vasos para apretar Pernos de Impacto

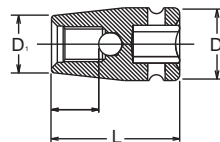



HAND MANUALES  
Z-SERIES  
TITANIUM DE TITANIO  
ACCESSORIES ACCESORIOS  
SCREWDRIVERS DESTORNILLADORES  
IMPACT DE IMPACTO  
SLEEVE-DRIVE INDUSTRIAL INDUSTRIALES  
AUTOMOTIVE  
CONSTRUCTION CONSTRUCCION  
RENEWAL KITS JUEGOS DE PIEZAS REPIESTO

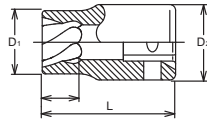

HAND MANUALES  
Z-SERIES  
TITANIUM DE TITANIO  
ACCESSORIES ACCESORIOS  
SCREWDRIVERS DESTORNILLADORES  
IMPACT DE IMPACTO  
SLEEVE-DRIVE  
INDUSTRIAL INDUSTRIALES  
AUTOMOTIVE  
CONSTRUCTION CONSTRUCCION  
RENEWAL KITS JUEGOS DE PIEZAS/REPLUSTO

**2127**  NUTTWISTER® AFLOJA TUERCAS



2127 (mm)		D <sub>1</sub> (mm)	D <sub>2</sub> (mm)	(mm)	L (mm)	(g)	(pcs.)
4	1/4"	7	13	4	23	14	10
4.5		7.4	13	4	23	14	10
5		8	13	5	23	14	10
5.5		8.8	13	5	23	14	10
6		9.5	13	6	23	14	10
7		10.9	13	6	23	14	10
8		11.5	13	8	23	14	10
9		13	13	8	23	15	10
9.5		13.8	13	10	23	16	10
10		14.8	13	10	23	17	10

**RS2127/6**   Socket Set on Rail Juego de Vasos en Regleta



RS2127/6	6 Pieces Set/Rail 150mm	(g)
4, 4.5, 5, 5.5, 6, 7		105

**RS2127/10**   Socket Set on Rail Juego de Vasos en Regleta



RS2127/10	10 Pieces Set/Rail 150mm	(g)
4, 4.5, 5, 5.5, 6, 7, 8, 9, 9.5, 10		180

**3127**  NUTTWISTER® AFLOJA TUERCAS

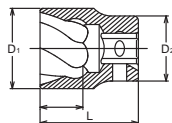

3127 (mm)		D <sub>1</sub> (mm)	D <sub>2</sub> (mm)	(mm)	L (mm)	(g)	(pcs.)
8	3/8"	11.5	19	8	32	40	10
9		13	19	8	32	40	10
9.5		13.8	19	8	32	41	10
10		14.8	19	10	32	41	10
11		16	19	10	32	43	10
12		17	19	12	32	44	10
13		18.5	19	12	32	46	10
14		19.7	19	14	32	48	10
15		20.7	19	14	32	52	10
16		22.2	22	14	32	66	10
17		23.5	22	16	35	80	10
19		26	22	16	35	92	10

**RS3127/8**   Socket Set on Rail Juego de Vasos en Regleta



RS3127/8	8 Pieces Set/Rail 200mm	(g)
8, 9, 10, 11, 12, 13, 14, 16		420

3128.80 (mm)		D <sub>1</sub> (mm)	D <sub>2</sub> (mm)	(mm)	L (mm)	(g)	(pcs.)
8	3/8"	13	19	6	80	58	10
9		14.5	19	6	80	61	10
10		15.8	19	8	80	66	10
11		17.2	19	8	80	70	10
12		18.5	19	10	80	77	10
13		19.7	19	10	80	80	10
14		21	19	12	80	82	10

**3128-80** NUTTWISTER® (Long type)  
AFLOJA TUERCAS (Serie Larga)

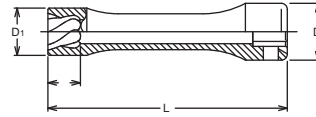

4127 (mm)		D <sub>1</sub> (mm)	D <sub>2</sub> (mm)	(mm)	L (mm)	(g)	(pcs.)
14	1/2"	19.7	30	14	42	125	10
17		23.5	30	16	42	137	10
19		26	30	16	42	146	10
21		28	30	17	42	153	10
22		29.5	30	17	42	158	10
24		32	30	18	42	174	10
25.4		33.5	30	18	42	183	10

**4127** NUTTWISTER®  
AFLOJA TUERCAS

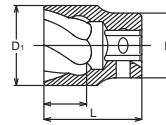

RS4127/6	6 Pieces Set/Rail 200mm	(g)
17, 19, 21, 22, 24, 25.4		960

**RS4127/6** Socket Set on Rail  
Juego de Vasos en Regleta



**4128-120** NUTTWISTER® (Long type)  
AFLOJA TUERCAS (Serie Larga)

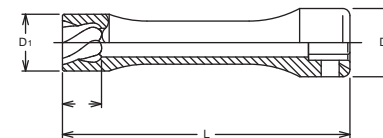

4128.120 (mm)		D <sub>1</sub> (mm)	D <sub>2</sub> (mm)	(mm)	L (mm)	(g)	(pcs.)
17	1/2"	25.8	30	16	120	227	10
19		28.4	30	16	120	247	10
21		31	30	17	120	262	10
22		32	30	17	120	259	10

A very effective method and easy solution for removing rounded off nuts, bolts and studs. The sharp edges of the NUTTWISTER® Socket opening will tighten around the nut, bolt or stud and turn it easily off.

Un método muy efectivo y una fácil solución para aflojar tuercas, pernos y espárragos redondeados por desgaste. Las afiladas aristas de la boca del vaso AFLOJA TUERCAS NUTTWISTER®, aprietan contra la tuerca, perno o espárrago, haciéndolo girar fácilmente.



HAND MANUALES  
Z-SERIES  
TITANIUM DE TITANIO  
ACCESSORIES ACCESORIOS  
SCREWDRIVERS DESTORNILLADORES  
IMPACT DE IMPACTO  
SLEEVE-DRIVE  
INDUSTRIAL INDUSTRIALES  
AUTOMOTIVE  
CONSTRUCTION CONSTRUCCION  
RENEWAL KITS JUEGOS DE PIEZAS REPIESTO

**3129-32** BOLTTWISTER®  
AFLOJA PERNOS

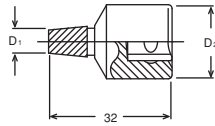

3129.32 (mm)	□	D <sub>1</sub> (mm)	D <sub>2</sub> (mm)	L (mm)	(g)	(pcs.)
2	3/8"	2	19	32	32	10
3		3	19	32	33	10
4		4	19	32	33	10
6		6	19	32	35	10
8		8	19	32	37	10
10		10	19	32	40	10

**RS3129/6-L32** Socket Set on Rail  
Juego de Vasos en Regleta



RS3129/6-L32	6 Pieces Set/Rail 150mm	(g)
2, 3, 4, 6, 8, 10		250

**3129-60** BOLTTWISTER®  
AFLOJA PERNOS

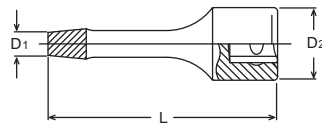

3129.60 (mm)	□	D <sub>1</sub> (mm)	D <sub>2</sub> (mm)	L (mm)	(g)	(pcs.)
2	3/8"	2	19	60	38	10
3		3	19	60	42	10
4		4	19	60	44	10
6		6	19	60	47	10
8		8	19	60	53	10
10		10	19	60	64	10

**RS3129/6-L60** Socket Set on Rail  
Juego de Vasos en Regleta



RS3129/6-L60	6 Pieces Set/Rail 150mm	(g)
2, 3, 4, 6, 8, 10		320

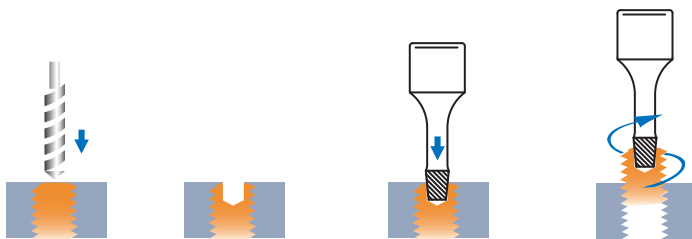

Effective method and easy solution for removing twisted off bolt. Drill a hole in the center of bolt and drive BOLTTWISTER® firmly into the hole. The sharp spiral edges will hold the broken bolt and easily remove it.

Un método efectivo y una fácil solución para aflojar pernos rotos. Taladrar un agujero en el centro del perno e introducir el AFLOJA PERNOS BOLTTWISTER® presionando y girando. Las afiladas aristas espirales agarran el perno roto sacándolo.

BOLTTWISTER	Bolt size	Drill size
2	M5	2.4 2.6
3	M6	3.2 3.5
4	M8	4.2 4.5
6	M10 M12	6.2 6.5
8	M14 M16	8.2 8.5
10	M18 M20	10.2 10.5
12	M22 M24	12.2 12.5
14	M27 M30	14.2 14.5
16	M33	16.2 16.5

4129.37 (mm)		D <sub>1</sub> (mm)	D <sub>2</sub> (mm)	L (mm)	 (g)	 (pcs.)
8	1/2"	8	24	37	59	10
10		10	24	37	63	10
12		12	24	37	67	10
14		14	24	37	72	10
16		16	24	37	78	10

RS4129/5-L37	5 Pieces Set/Rail 150mm	 (g)
8, 10, 12, 14, 16		370

4129.75 (mm)		D <sub>1</sub> (mm)	D <sub>2</sub> (mm)	L (mm)	 (g)	 (pcs.)
8	1/2"	8	24	75	80	10
10		10	24	75	94	10
12		12	24	75	110	10
14		14	24	75	130	10
16		16	24	75	150	10

RS4129/5-L75	5 Pieces Set/Rail 150mm	 (g)
8, 10, 12, 14, 16		600

**4129-37** BOLTTWISTER®  
AFLOJA PERNOS

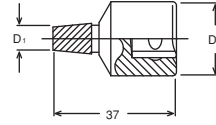

**RS4129/5-L37** Socket Set on Rail  
Juego de Vasos en Regleta



**4129-75** BOLTTWISTER®  
AFLOJA PERNOS

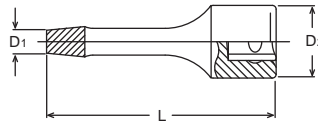

**RS4129/5-L75** Socket Set on Rail  
Juego de Vasos en Regleta



HAND  
MANUALES

Z-SERIES

TITANIUM  
DE TITANIO

ACCESSORIES  
ACCESORIOS

SCREWDRIVERS  
DESTORNILLADORES

IMPACT  
DE IMPACTO

SLEEVE-DRIVE

INDUSTRIAL  
INDUSTRIALES

AUTOMOTIVE

CONSTRUCTION  
CONSTRUCCION

RENEWAL KITS  
JUEGOS DE PIEZAS REBIERTO

# T-Type Wrench

HAND MANUALES  
Z-SERIES  
TITANIUM DE TITANIO  
ACCESSORIES ACCESORIOS  
SCREWDRIVERS DESTORNILLADORES  
IMPACT DE IMPACTO  
SLEEVE-DRIVE  
INDUSTRIAL INDUSTRIALES  
AUTOMOTIVE  
CONSTRUCTION CONSTRUCCION  
RENEWAL KITS JUEGOS DE PIEZAS REPLUSTO

## 156M 6-Point Deep Hexagonal Larga

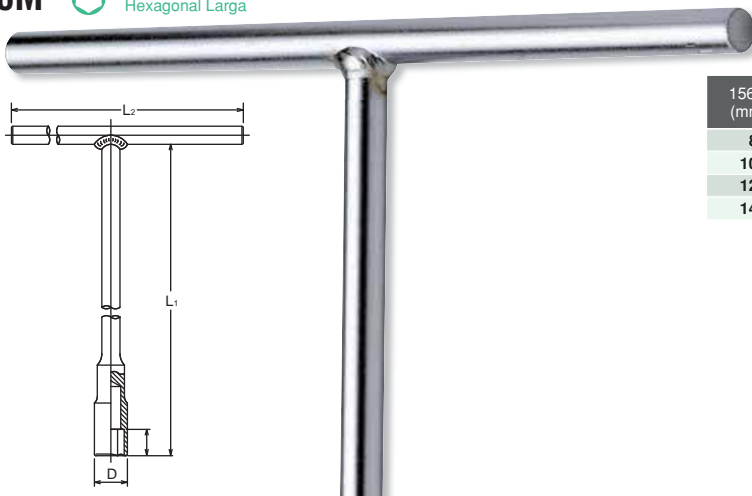

156M (mm)	D (mm)	(mm)	L <sub>1</sub> (mm)	L <sub>2</sub> (mm)	(g)	(pce.)
8	12	9	355	200	231	1
10	14.5	11	355	200	289	1
12	16.8	13	355	200	429	1
14	20	16	355	200	454	1

## 104M · 104A 6-Point Hexagonal



104M (mm)	D (mm)	(mm)	L <sub>1</sub> (mm)	L <sub>2</sub> (mm)	(g)	(pce.)
6	9.5	8	200	180	150	1
7	11	9	200	180	152	1
8	12	10	250	200	183	1
9	14	12	250	200	188	1
10	14	13	250	200	230	1
11	16	14	250	200	234	1
12	18	15	250	250	384	1
13	18.5	17	300	250	412	1
14	20	18	300	250	428	1
15	21	19	300	250	443	1
16	22.5	21	350	300	528	1
17	24	22	350	300	707	1
18	25	23	350	300	707	1
19	26.5	25	350	300	717	1
21	29	27	350	300	1070	1
22	30	28	350	300	1062	1
New 24	33	30	350	300	1140	1

104A (inch)	D (mm)	(mm)	L <sub>1</sub> (mm)	L <sub>2</sub> (mm)	(g)	(pce.)
1/4	9.5	8	200	180	150	1
5/16	12	10	250	200	183	1
3/8	14	12	250	200	188	1
7/16	16	14	250	200	234	1
1/2	18.5	17	300	250	412	1
9/16	20	18	300	250	428	1
5/8	22.5	21	350	300	528	1
3/4	26.5	25	350	300	717	1



**3116M**  Universal with 6-point Socket  
Con articulación universal con Vaso Hexagonal

**124M-600 (2B)**  Ball Joint plus Nut Grip Socket  
Con articulación de rótula y Vaso Sujeta Tuerca

3116M (mm)	D (mm)	(mm)	L <sub>1</sub> (mm)	L <sub>2</sub> (mm)	(g)	(pce.)
10	14.5	8	800	190	796	1
12	17	10.3	800	190	797	1
13	18	11.3	800	190	797	1
14	19.5	11.3	800	190	797	1
15	21	12.8	800	190	799	1
16	22	12.8	800	190	806	1
17	23.6	13.8	800	190	801	1
18	24	13.8	800	190	809	1

124M.600 (mm)	D (mm)	(mm)	L <sub>1</sub> (mm)	L <sub>2</sub> (mm)	(g)	(pce.)
8(2B)	12	5	600	200	332	1
10(2B)	14.5	6	600	200	334	1
12(2B)	16.8	7	600	200	424	1
13(2B)	18	8	600	200	425	1
14(2B)	19.5	8.5	600	200	527	1
17(2B)	23.3	9.5	600	200	538	1

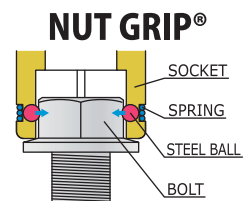
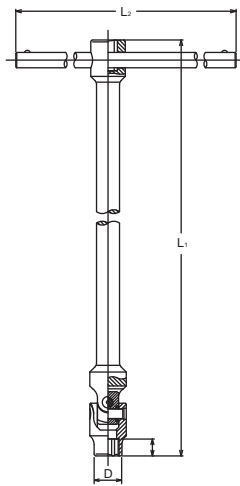

Twin balls at the 6-point opening hold bolt-nut tightly for safe and reliable work.

Las dos bolas de la boca Hexagonal sujetan el perno-tuerca permitiendo un trabajo seguro y fiable.

HAND MANUALES  
Z-SERIES  
TITANIUM DE TITANIO  
ACCESSORIES ACCESORIOS  
SCREWDRIVERS DESTORNILLADORES  
IMPACT DE IMPACTO  
SLEEVE-DRIVE INDUSTRIAL INDUSTRIALES  
AUTOMOTIVE  
CONSTRUCTION CONSTRUCCION  
RENEWAL KITS JUEGOS DE PIEZAS REPIESTO

# T-Type Wrench

HAND MANUALES  
Z-SERIES  
TITANIUM DE TITANIO  
ACCESSORIES ACCESORIOS  
SCREWDRIVERS DESTORNILLADORES  
IMPACT DE IMPACTO  
SLEEVE-DRIVE  
INDUSTRIAL INDUSTRIALES  
AUTOMOTIVE  
CONSTRUCTION CONSTRUCCIÓN  
RENEWAL KITS JUEGOS DE PIEZAS/REPLUESTO

## 157H

 For Inhex Screws  
Para Tornillos de Seis Lados en el Interior (Inhex)

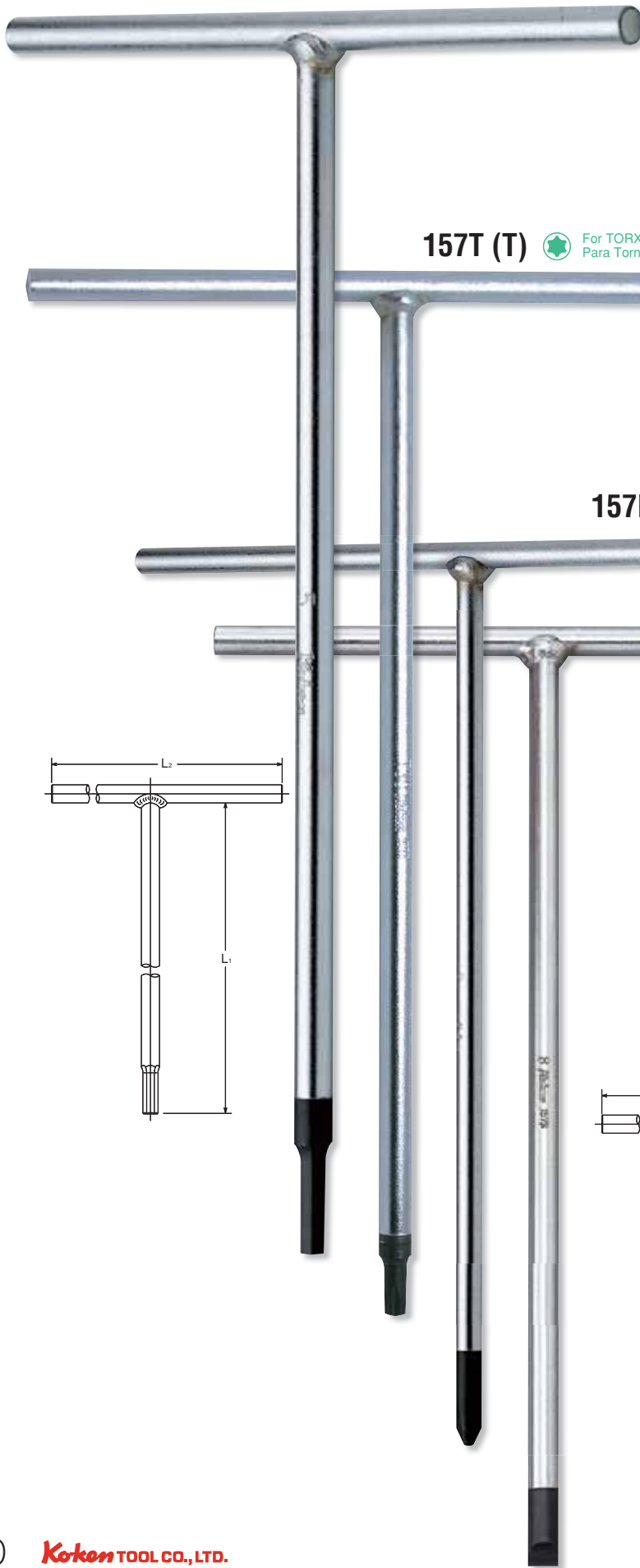

157H (mm)	L <sub>1</sub> (mm)	L <sub>2</sub> (mm)	(g)	(pce.)
3	160	100	57	1
4	200	120	70	1
5	250	160	90	1
6	300	190	147	1
New 7	300	190	193	1
8	300	190	245	1
10	300	190	433	1
New 12	320	210	662	1
New 14	340	220	879	1
New 17	340	220	1369	1

## 157T (T)

 For TORX® Screws  
Para Tornillos TORX®

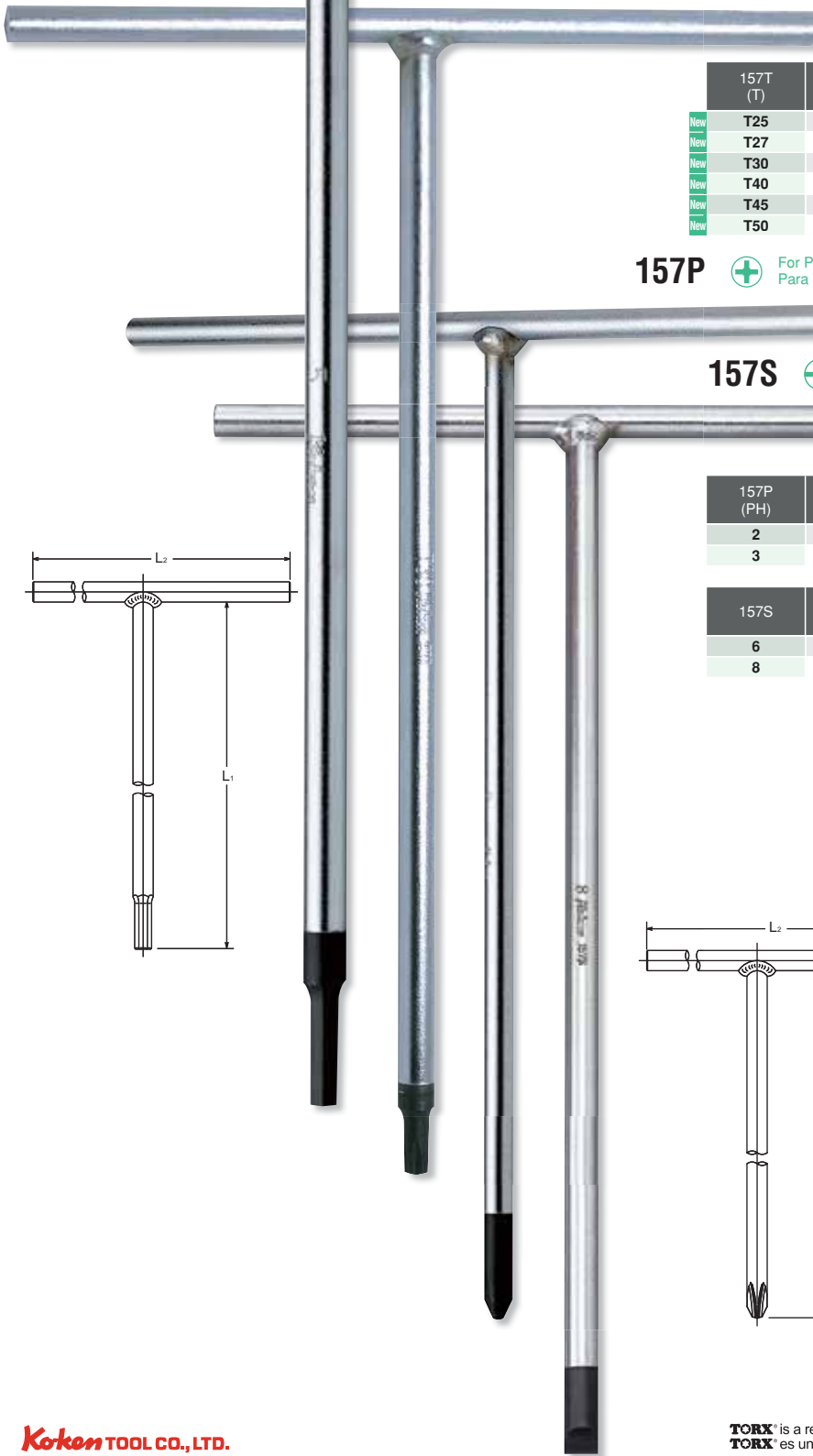

157T (T)	L <sub>1</sub> (mm)	L <sub>2</sub> (mm)	(g)	(pce.)
New T25	250	180	95	1
New T27	250	180	96	1
New T30	250	180	167	1
New T40	250	180	168	1
New T45	250	180	213	1
New T50	250	180	215	1

## 157P

 For Phillips Screws  
Para Tornillos Phillips

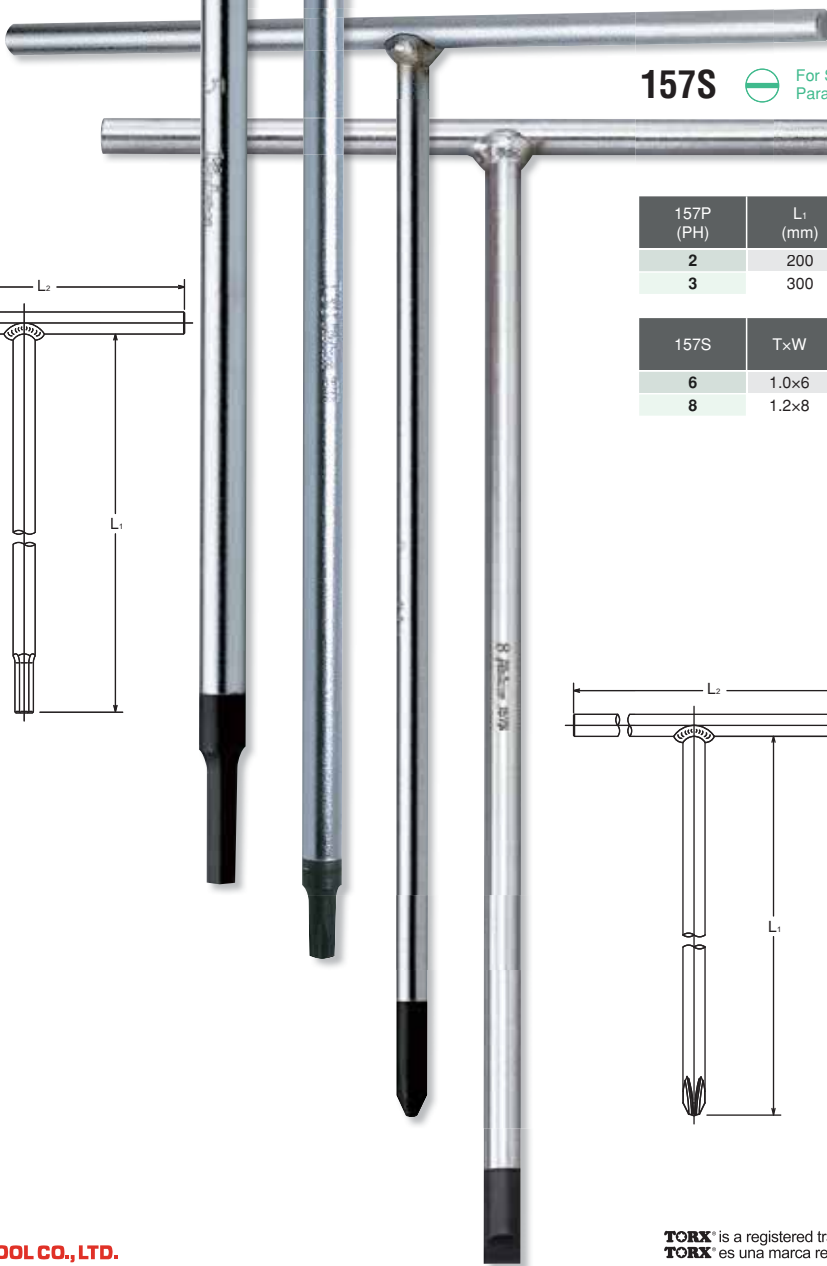

157P (PH)	L <sub>1</sub> (mm)	L <sub>2</sub> (mm)	(g)	(pce.)
2	200	180	84	1
3	300	180	189	1

157S	T×W	L <sub>1</sub> (mm)	L <sub>2</sub> (mm)	(g)	(pce.)
6	1.0×6	200	180	84	1
8	1.2×8	250	180	170	1

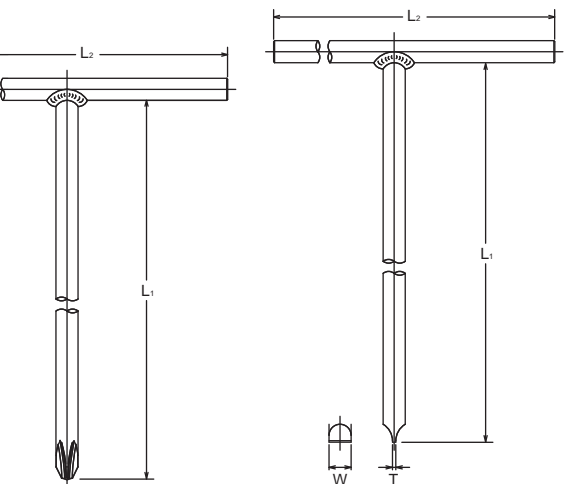

**2715**  T-Handle  
Llaves en T



**3715**  T-Handle  
Llaves en T

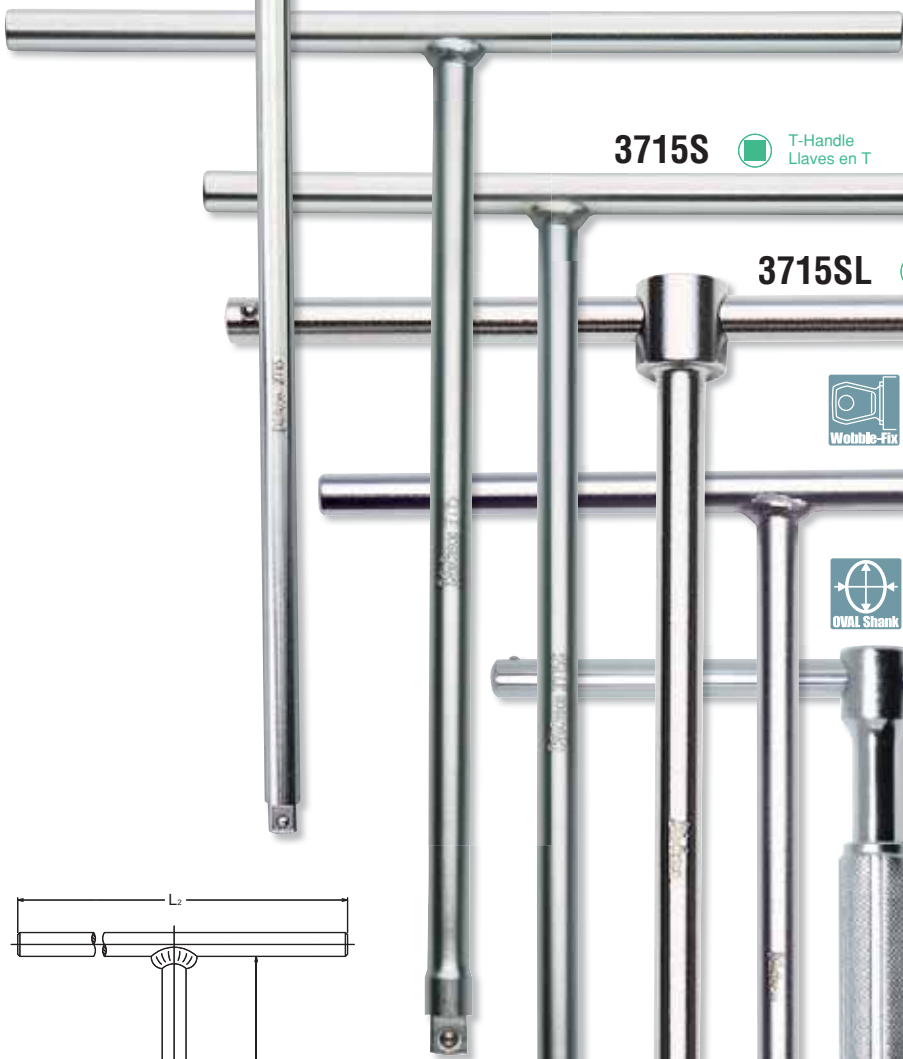

**3715S**  T-Handle  
Llaves en T



**3715SL**  T-Handle  
Llaves en T



**3716**  T-Handle  
Llaves en T 





**3715SLK**  T-Handle  
Llaves en T

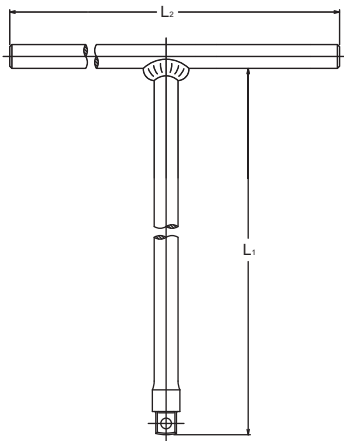

**3715SLK**



		L <sub>1</sub> (mm)	L <sub>2</sub> (mm)	 (g)	 (pce.)
<b>2715</b>	1/4"	200	120	130	1

		L <sub>1</sub> (mm)	L <sub>2</sub> (mm)	 (g)	 (pce.)
<b>3715</b>	3/8"	268	240	386	1
<b>3715S</b>		268	190	347	1
<b>3715SL</b>		237	200	325	1
<b>3715SLK</b>		236	200	470	1
<b>3716</b>		268	240	379	1

 2715/3715/3716  
This tool is used sockets in hard to reach places. 3716 has a reduced square drive and similar function as offset extension bars.

HAND  
MANUALES  
Z-SERIES  
TITANIUM  
DE TITANIO  
ACCESSORIES  
ACCESORIOS  
SCREWDRIVERS  
DESTORNILLADORES  
IMPACT  
DE IMPACTO  
SLEEVE-DRIVE  
INDUSTRIAL  
INDUSTRIALES  
AUTOMOTIVE  
CONSTRUCTION  
CONSTRUCCION  
RENEWAL KITS  
JUEGOS DE PIEZAS REPUESTO

# T-Type Wrench





HAND MANUALES  
Z-SERIES  
TITANIUM DE TITANIO  
ACCESSORIES ACCESORIOS  
SCREWDRIVERS DESTORNILLADORES  
IMPACT DE IMPACTO  
SLEEVE-DRIVE  
INDUSTRIAL INDUSTRIALES  
AUTOMOTIVE  
CONSTRUCTION CONSTRUCCION  
RENEWAL KITS JUEGOS DE PIEZAS/REPLUESTO

**4715**  T-Handle  
Llaves en T

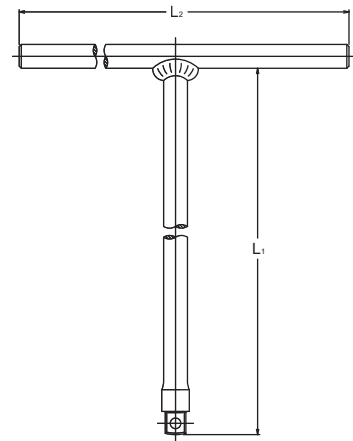
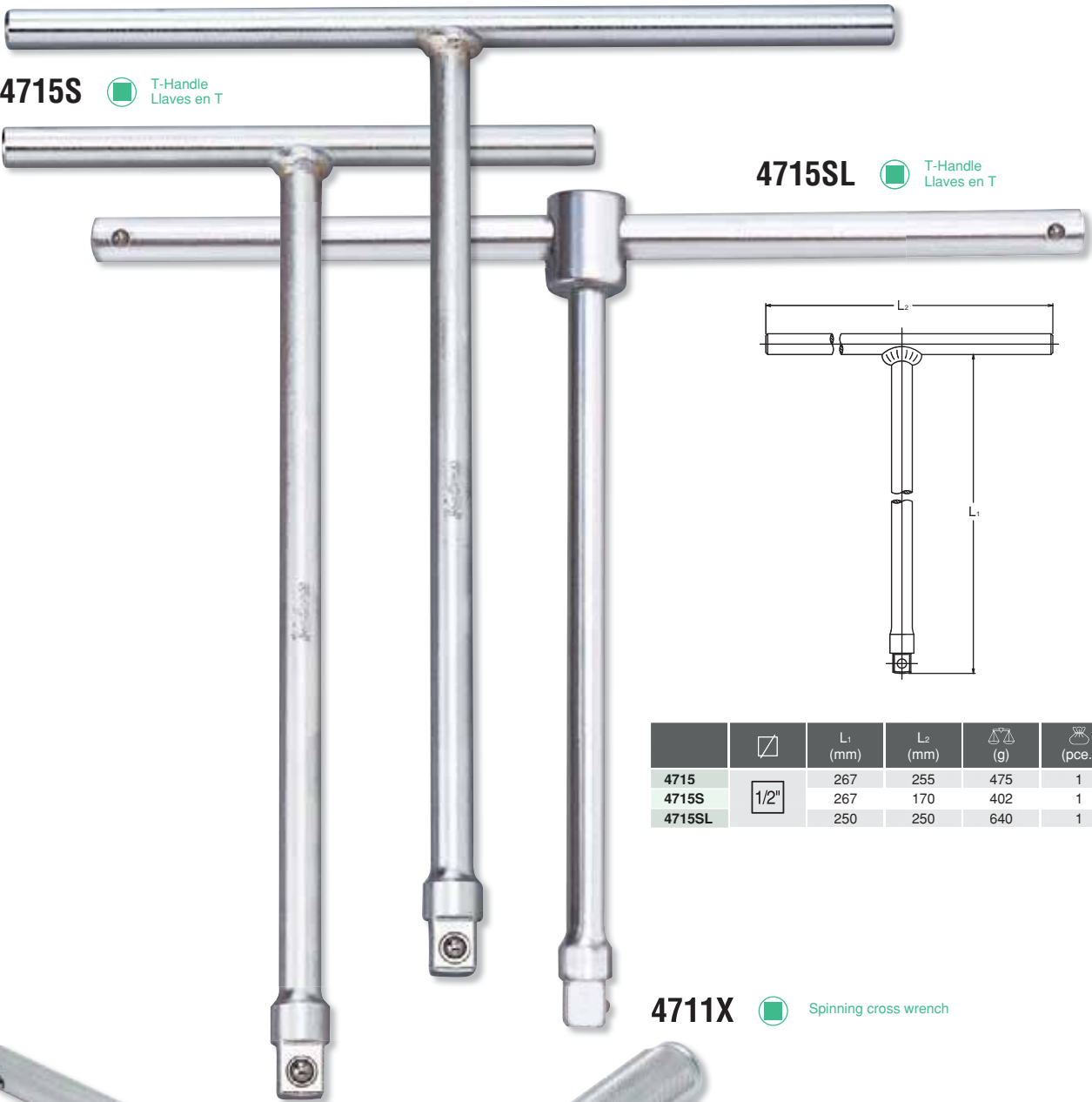
**4715S**  T-Handle  
Llaves en T





**4715SL**  T-Handle  
Llaves en T

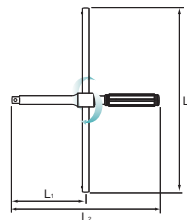

		L <sub>1</sub> (mm)	L <sub>2</sub> (mm)	 (g)	 (pce.)
4715		267	255	475	1
4715S		267	170	402	1
4715SL		250	250	640	1

**4711X**  Spinning cross wrench



		L <sub>1</sub> (mm)	L <sub>2</sub> (mm)	L <sub>3</sub> (mm)	 (g)	 (pce.)
4711X		140	280	350	945	1

	3131A		S(mm)		L (mm)		
			Min.	Max.			
New	1		2.0	5.0	40	80	5
New	2		4.5	8.0	45	100	5

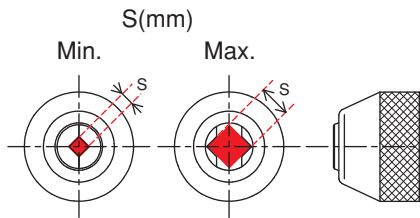

Tap is not included.

		C (mm)	L (mm)		
160K		10	220	126	1

		S (mm)	D (mm)	H (mm)	L (mm)		
New		20	28	17	7	60	130
New		25	34	22	9	60	170
New		38	48	24	13	80	315
New		50	60	27	16	105	740



Die is not included.

**3131A** Tap Holder, Adjustable  
Adaptadores para machos de terrajas

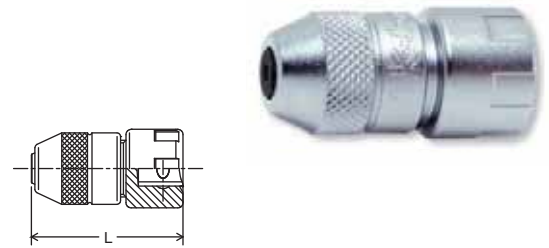

**160K** Handle  
Llave

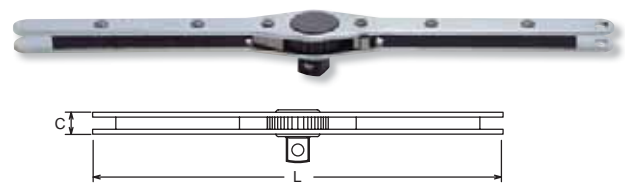

**3132** Die Holder  
Adaptadores

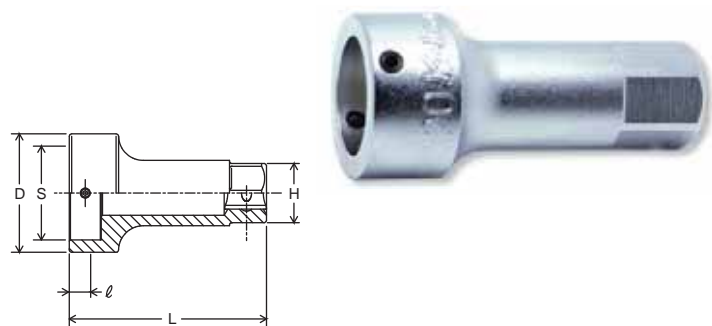

**4132** Die Holders  
Adaptadores



HAND  
MANUALES  
Z-SERIES  
TITANIUM  
DE TITANIO  
ACCESSORIES  
ACCESORIOS  
SCREWDRIVERS  
DESTORNILLADORES  
IMPACT  
DE IMPACTO  
SLEEVE-DRIVE  
INDUSTRIAL  
INDUSTRIALES  
AUTOMOTIVE  
CONSTRUCTION  
CONSTRUCCION  
RENEWAL KITS  
JUEGOS DE PIZAS REPIESTO





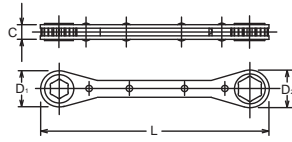

# Ratcheting Ring Wrench

HAND MANUALES  
Z-SERIES  
TITANIUM DE TITANIO  
ACCESSORIES ACCESORIOS  
SCREWDRIVERS DESTORNILLADORES  
IMPACT DE IMPACTO  
SLEEVE-DRIVE  
INDUSTRIAL INDUSTRIALES  
AUTOMOTIVE  
CONSTRUCTION CONSTRUCCION  
RENEWAL KITS JUEGOS DE PIEZAS REPLUESTO

## 102NM • 102NA Without reverse lever Sin palanca de inversión





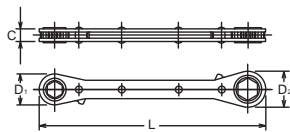

102NM (mm)	L (mm)	D <sub>1</sub> (mm)	D <sub>2</sub> (mm)	C (mm)	 (g)	 (pcs.)
6x7	108	15.3	16.4	7.5	60	10
7x8	108	15.3	16.4	7.5	60	10
8x9	134	17.1	19.7	7.5	80	10
8x10	134	17.1	19.7	7.5	80	10
10x11	140	20.1	22.7	7.5	87	10
10x12	140	20.1	22.7	7.5	87	10
12x13	145	23.6	24.6	9	112	10
12x14	145	23.6	24.6	9	112	10

102NA (inch)	L (mm)	D <sub>1</sub> (mm)	D <sub>2</sub> (mm)	C (mm)	 (g)	 (pcs.)
7/32 x 1/4	108	15.3	16.4	7.5	60	10
1/4 x 9/32	108	15.3	16.4	7.5	60	10
1/4 x 5/16	108	15.3	16.4	7.5	60	10
5/16 x 11/32	134	17.1	19.7	7.5	80	10
5/16 x 3/8	134	17.1	19.7	7.5	80	10
3/8 x 7/16	140	20.1	22.7	7.5	87	10
7/16 x 1/2	145	23.6	24.6	9	112	10
1/2 x 9/16	145	23.6	24.6	9	112	10

## 102KM • 102KA Reversible Reversible





102KM (mm)	L (mm)	D <sub>1</sub> (mm)	D <sub>2</sub> (mm)	C (mm)	 (g)	 (pcs.)
6x7	108	15.3	16.4	7.5	51	10
7x8	108	15.3	16.4	7.5	51	10
8x9	134	17	20	9	76	10
8x10	134	17	20	9	76	10
10x11	141	21	23.5	9	84	10
10x12	141	21	23.5	9	84	10
12x13	146	24	25	9	89	10
12x14	146	24	25	9	89	10
13x17	200	27.1	31.8	16	190	5
14x17	200	27.1	31.8	16	200	5

102KA (inch)	L (mm)	D <sub>1</sub> (mm)	D <sub>2</sub> (mm)	C (mm)	 (g)	 (pcs.)
7/32 x 1/4	108	15.3	16.4	7.5	51	10
1/4 x 5/16	108	15.3	16.4	7.5	51	10
3/8 x 7/16	141	21	23.5	9	84	10
1/2 x 9/16	146	24	25	9	89	10

## 102KM (BH) With Twin Openings (Two-in-One) Con Bocas Gemelas (Dos en Uno)



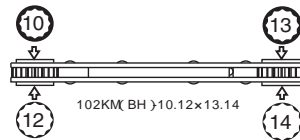

102KM.BH (mm)	L (mm)	D <sub>1</sub> (mm)	D <sub>2</sub> (mm)	C (mm)	 (g)	 (pcs.)
5.5 • 6 x 7 • 8	108	15.3	16.4	10	60	10
8 • 10 x 12 • 13	141	21	23.5	13	87	10
9 • 10 x 11 • 12	141	21	23.5	13	87	10
10 • 12 x 13 • 14	146	24	25	13	98	10
13 • 14 x 15 • 17	200	27.1	31.8	16	200	5

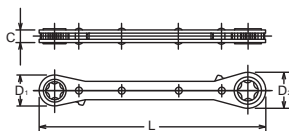

## 102KT Reversible TORX® Reversible TORX®



102KT (E)	L (mm)	D <sub>1</sub> (mm)	D <sub>2</sub> (mm)	C (mm)	 (g)	 (pcs.)
E 4x E 6	108	15.3	16.4	7.5	51	10
E 6x E 8	108	15.3	16.4	7.5	51	10
E 10x E 12	134	17	20	9	76	10

HAND MANUALES  
Z-SERIES  
TITANIUM DE TITANIO  
ACCESSORIES ACCESORIOS  
SCREWDRIVERS DESTORNILLADORES  
IMPACT DE IMPACTO  
SLEEVE-DRIVE  
INDUSTRIAL INDUSTRIALES  
AUTOMOTIVE  
CONSTRUCTION CONSTRUCCION  
RENEWAL KITS JUEGOS DE PIEZAS REPUESTO

103KM (mm)	L (mm)	D <sub>1</sub> (mm)	D <sub>2</sub> (mm)	C (mm)	(g)	(pcs.)
6x 7	108	15.3	16.4	7.5	51	5
7x 8	108	15.3	16.4	7.5	51	5
8x 9	134	17	20	9	76	5
8x10	134	17	20	9	76	5
10x11	140	21	23.5	9	84	5
10x12	140	21	23.5	9	84	5
12x13	145	24	25	9	89	5
12x14	145	24	25	9	89	5

103KA (inch)	L (mm)	D <sub>1</sub> (mm)	D <sub>2</sub> (mm)	C (mm)	(g)	(pcs.)
7/32x 1/4	108	15.3	16.4	7.5	51	5
1/4 x 5/16	108	15.3	16.4	7.5	51	5
5/16x11/32	134	17	20	9	76	5
3/8 x 7/16	140	21	23.5	9	84	5
1/2 x 9/16	145	24	25	9	89	5

103KT (E)	L (mm)	D <sub>1</sub> (mm)	D <sub>2</sub> (mm)	C (mm)	(g)	(pcs.)
E 4xE 6	104	15.3	16.4	7.5	51	5
E 6xE 8	104	15.3	16.4	7.5	51	5
E10xE12	128	17	20	9	76	5
E14xE16	139	24	25	9	89	5

R810 (inch)	L (mm)	D <sub>1</sub> (mm)	D <sub>2</sub> (mm)	C (mm)	(g)	(pcs.)
1/4x5/16	108	15.3	16.4	7.5	60	10
3/8x7/16	140	20.1	22.7	7.5	87	10
1/2x9/16	145	23.6	24.6	9	112	10

**103KM • 103KA** Reversible Reversible

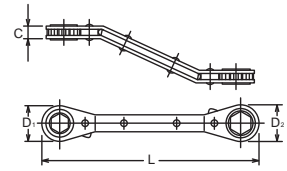

**103KT** Reversible TORX® Reversible TORX®

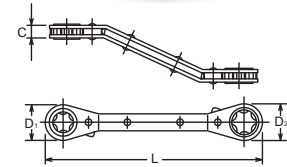

**R810** Reversible Reversible

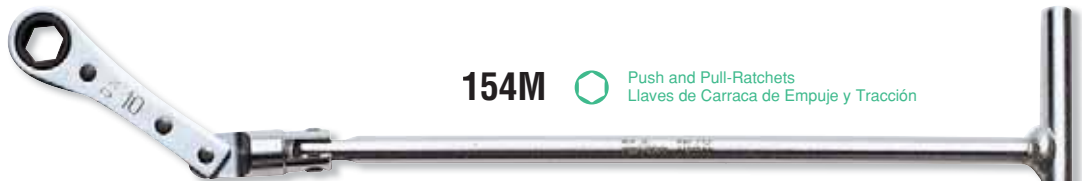

**154M** Push and Pull-Ratchets Llaves de Carraca de Empuje y Tracción

154M (mm)	L (mm)	D (mm)	C (mm)	(g)	(pcs.)
8	294	17.1	7.5	178	2
10	297	20.1	7.5	183	2
12	300	23.6	9	189	2
13	301	24.6	9	194	2
14	301	24.6	9	194	2

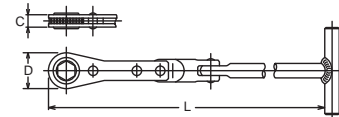

**154ML** Push and Pull-Ratchets Llaves de Carraca de Empuje y Tracción

154ML (mm)	L (mm)	D (mm)	C (mm)	(g)	(pcs.)
10	297	20.1	7.5	230	2
12	300	23.6	9	252	2

# Ratcheting Ring Wrench

HAND MANUALES  
Z-SERIES  
TITANIUM DE TITANIO  
ACCESSORIES ACCESORIOS  
SCREWDRIVERS DESTORNILLADORES  
IMPACT DE IMPACTO  
SLEEVE-DRIVE  
INDUSTRIAL INDUSTRIALES  
AUTOMOTIVE  
CONSTRUCTION CONSTRUCCION  
RENEWAL KITS JUEGOS DE PIEZAS REPLÉSTO

**137**  For 1/4" and 3/8" Square Drive Sockets  
Para Vasos con Conductor Cuadrado de 1/4" y 3/8"

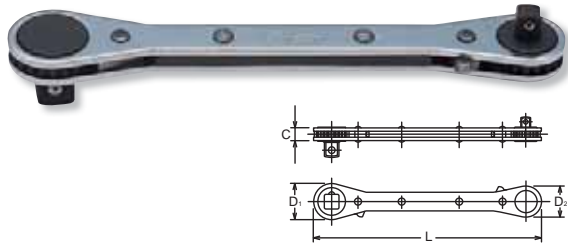

	L (mm)	D <sub>1</sub> (mm)	D <sub>2</sub> (mm)	C (mm)	(g)	(pcs.)
<b>137</b>	141	23.5	21	9	104	5

1/4" x 3/8"

**138**   For Bits 101  
Para Puntas 101

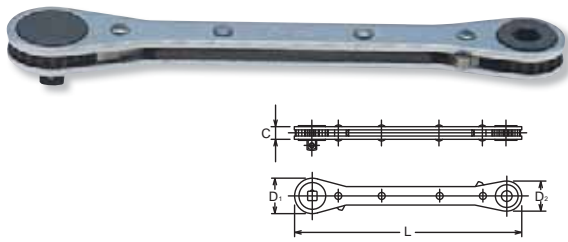

	L (mm)	D <sub>1</sub> (mm)	D <sub>2</sub> (mm)	C (mm)	(g)	(pcs.)
<b>138</b>	141	23.5	21	9	97	10

1/4" x 1/4"

**139**  For 1/4" Square Drive Sockets  
Para Vasos con Conductor Cuadrado de 1/4"

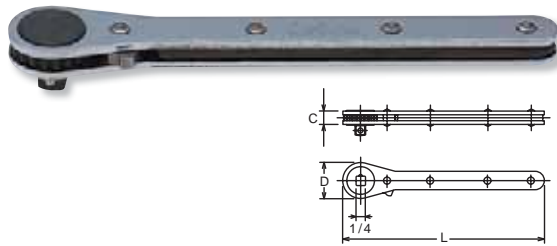

	L (mm)	D (mm)	C (mm)	(g)	(pcs.)
<b>139</b>	125	20.1	7.5	80	10

1/4"



**145KM-10H**  Reversible, 10mm 6-pt.  
Reversible, 10mm Hexagonal

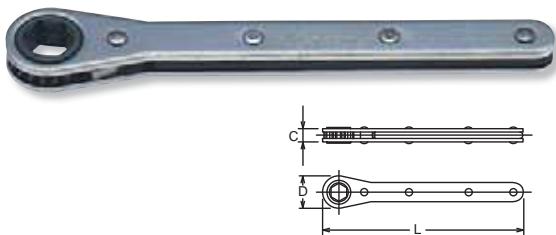

145KM (mm)	L (mm)	D (mm)	C (mm)	(g)	(pcs.)
<b>10H</b>	125	20.1	7.5	72	10

**150-10H**  Sockets with 10mm 6-point Drive End  
Vasos con Conductor Hexagonal 10mm



150.10H (mm)	D (mm)	(mm)	L (mm)	(g)	(pcs.)
<b>5</b>	12	3.5	11	6	10
<b>6</b>	12	4.5	12.5	7	10
<b>7</b>	12	5	14	7	10
<b>8</b>	12	6	15.5	7	10
<b>9</b>	13	6	16	7	10
<b>10</b>	14.3	7	17	9	10

**1203**  Sockets with 10mm 6-point Drive End in Set with Ratchet  
Juego de Vasos con Conductor Hex con Llave de Carraca



1203		7 Pieces Set/7=250g	
METAL CASE:W130xH65xT20mm			
Sockets		Accessory	
	<b>150.10H</b> 5, 6, 7, 8, 9, 10	<b>145KM-10H</b>	

HAND  
MANUALES

Z-SERIES

TITANIUM  
DE TITANIO

ACCESSORIES  
ACCESORIOS

SCREWDRIVERS  
DESTORNILLADORES

IMPACT  
DE IMPACTO



SLEEVE-DRIVE  
INDUSTRIAL

INDUSTRIAL

AUTOMOTIVE



CONSTRUCTION  
CONSTRUCCION

RENEWAL KITS  
JUEGOS DE PIEZAS REPIESTO

R810A		5 Pieces Set/▲=208g	
METAL CASE:W130xH65xT20mm			
Bits	Accessory		
 <b>101P</b> Phillips Bits 1, 2, 3	 <b>102NA-1/4x5/16</b>		
 <b>101S</b> Slotted Bit 1x7			



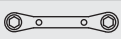

**R810A** Bit Set  
Juego de Puntas



R810B		10 Pieces Set/▲=268g	
METAL CASE:W130xH65xT20mm			
Bits	Accessory		
 <b>101P</b> Phillips Bits 1, 2, 3	 <b>102NA-1/4x5/16</b>		
 <b>101S</b> Slotted Bit 1x7			
 <b>128H</b> Hex Bits 3, 4, 5, 6, 8			







**R810B** Bit Set  
Juego de Puntas



R810C		12 Pieces Set/▲=227g	
METAL CASE:W130xH65xT20mm			
Bits, Sockets	Accessories		
 <b>101P</b> Phillips Bits 1, 2, 3	 <b>102NA-1/4x5/16</b>		
 <b>101S</b> Slotted Bit 1x7	 <b>101A</b>		
 <b>2400M</b> Sockets 5, 6, 7, 8, 9, 10			



**R810C** Bit and Socket Set  
Juego de Puntas y Vasos



R810D		17 Pieces Set/▲=336g	
METAL CASE:W130xH65xT20mm			
Bits, Sockets	Accessories		
 <b>101P</b> Phillips Bits 1, 2, 3	 <b>102NA-1/4x5/16</b>		
 <b>101S</b> Slotted Bit 1x7	 <b>101A</b>		
 <b>128H</b> Hex Bits 3, 4, 5, 6, 8			
 <b>2400M</b> Sockets 5, 6, 7, 8, 9, 10			

**R810D** Bit and Socket Set  
Juego de Puntas y Vasos

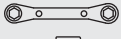

R810E		9 Pieces Set/▲=445g	
METAL CASE:W130xH65xT20mm			
Sockets	Accessories		
 <b>2300M</b> Deep Sockets 6, 7, 8, 9, 10, 11, 12	 <b>102NA-1/4x5/16</b>		
	 <b>101A</b>		

**R810E** Socket Set  
Juego de Vasos



# Ratcheting Ring Wrench

HAND MANUALES  
Z-SERIES  
TITANIUM DE TITANIO  
ACCESSORIES ACCESORIOS  
SCREWDRIVERS DESTORNILLADORES  
IMPACT DE IMPACTO  
SLEEVE-DRIVE  
INDUSTRIAL INDUSTRIALES  
AUTOMOTIVE  
CONSTRUCTION CONSTRUCCION  
RENEWAL KITS JUEGOS DE PIEZAS REPLUSTO

## 101P Phillips Bits Puntas Phillips

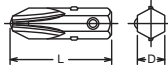

101P (PH)	D (mm)	L (mm)	(g)	(pcs.)
1	6.35	20.5	3	10
2	6.35	20.5	4	10
3	6.35	20.5	5	10

## 101S Bits for Slotted head Puntas Rectas/Planas

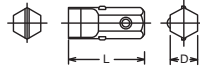

101S	D (mm)	L (mm)	(g)	(pcs.)
1.0x7	6.35	15	3	10
1.2x7	6.35	15	3	10

## 101H Hex Bits Puntas Hexagonales

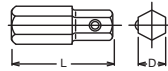

101H (mm)	D (mm)	L (mm)	(g)	(pcs.)
3	6.35	20.5	5	10
4	6.35	20.5	5	10
5	6.35	20.5	5	10
6	6.35	20.5	5	10
7	6.35	20.5	6	10
8	6.35	20.5	7	10

## 101B Ball-point Hex Bits Puntas Hexagonales con bola

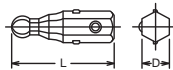

101B (mm)	D (mm)	L (mm)	(g)	(pcs.)
3	6.35	25	4	10
4	6.35	25	4	10
5	6.35	25	5	10
6	6.35	25	5	10

 Ball point bits have less strength due to the special design. Make sure to use them correctly.

## 101T (T) TORX® Bits Puntas TORX®

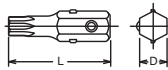

101T (T)	D (mm)	L (mm)	(g)	(pcs.)
T 9	6.35	25	4	10
T10	6.35	25	4	10
T15	6.35	25	5	10
T20	6.35	25	5	10
T25	6.35	25	5	10
T27	6.35	25	6	10
T30	6.35	25	6	10

## 101T (TH) Tamper-Resistant TORX® Bits Punta TORX®, indeformable

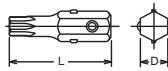

101T (TH)	D (mm)	L (mm)	(g)	(pcs.)
T10H	6.35	25	4	10
T15H	6.35	25	4	10
T20H	6.35	25	5	10
T25H	6.35	25	5	10
T27H	6.35	25	6	10
T30H	6.35	25	6	10

 Tamper Resistant TORX® Bits have less strength due to special design. Make sure to use it correctly.



128H (mm)	D (mm)	L (mm)	(g)	(pcs.)
3	8	32	11	10
4	8	32	11	10
5	8	32	12	10
6	8	32	12	10
8	8	32	13	10

128T (T)	D (mm)	L (mm)	(g)	(pcs.)
T10	8	32	9	10
T15	8	32	9	10
T20	8	32	9	10
T25	8	32	10	10
T27	8	32	10	10
T30	8	32	11	10

101A	D (mm)	S (mm)	L (mm)	(g)	(pcs.)
	8	6.35	20	8	10

**128H** Hex Bits Puntas Hexagonales

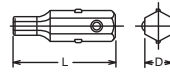

**128T** TORX® Bits Puntas TORX®

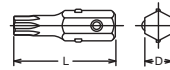

**101A** Adaptor Adaptador

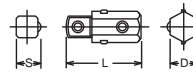

1202 15 Pieces Set/ 420g	
METAL CASE:W190xH60xT30mm	
Bits	Accessory
<ul style="list-style-type: none"> <li>101P Phillips Bits 1, 2, 3</li> <li>101S Slotted Bit 1x7</li> <li>101B Ballpoint Hex Bits 3, 4, 5, 6</li> <li>101T Torx® Bits T10, T15, T20, T25, T27, T30</li> </ul>	138

2254M 12 Pieces Set/ 450g	
METAL CASE:W160xH100xT28mm	
Bits	Accessories
<ul style="list-style-type: none"> <li>101P Phillips Bits 1, 2, 3</li> <li>101S Slotted Bits 1x7, 1.2x7</li> <li>101H Hex Bits 3, 4, 5</li> </ul>	<ul style="list-style-type: none"> <li>102NA-1/4x5/16</li> <li>2769F</li> <li>101A</li> <li>2137</li> </ul>

**1202** Bit Set Juego de Puntas



**2254M** Bit Set Juego de Puntas



HAND MANUALES Z-SERIES TITANIUM DE TITANIO ACCESSORIES ACCESORIOS SCREWDRIVERS DESTORNILLADORES IMPACT DE IMPACTO SLEEVE-DRIVE INDUSTRIAL INDUSTRIALES AUTOMOTIVE CONSTRUCTION CONSTRUCCION RENEWAL KITS JUEGOS DE PIEZAS REPIESTO

# ATTACK DRIVER®

HAND  
MANUALES

Z-SERIES

TITANIUM  
DE TITANIO

ACCESSORIES  
ACCESORIOS

SCREWDRIVERS  
DESTORNILLADORES

IMPACT  
DE IMPACTO

SLEEVE-DRIVE

INDUSTRIAL  
INDUSTRIALES

AUTOMOTIVE

CONSTRUCTION  
CONSTRUCCIÓN

RENEWAL KITS  
JUEGOS DE PIEZAS REPLISTO

**3112N** Attack Driver  
Destornillador de Impacto



	□	L (mm)	⚖ (g)	📦 (pce.)
3112N	3/8"	159	730	1
3112G		159	810	1

\* Renewal Kits → 3112RK → P279

**3112G** Attack Driver  
Destornillador de Impacto



	□	L (mm)	⚖ (g)	📦 (pce.)
4112N	1/2"	163	730	1
4112G		163	810	1

\* Renewal Kits → 4112RK → P279

**4112N** Attack Driver  
Destornillador de Impacto



	□	L (mm)	⚖ (g)	📦 (pce.)
6112	3/4"	190	1900	1

\* Renewal Kits → 6112RK → P279



Black finished head prevents peeling off the chrome plate by striking the head.

**4112G** Attack Driver  
Destornillador de Impacto



**6112** Attack Driver  
Destornillador de Impacto

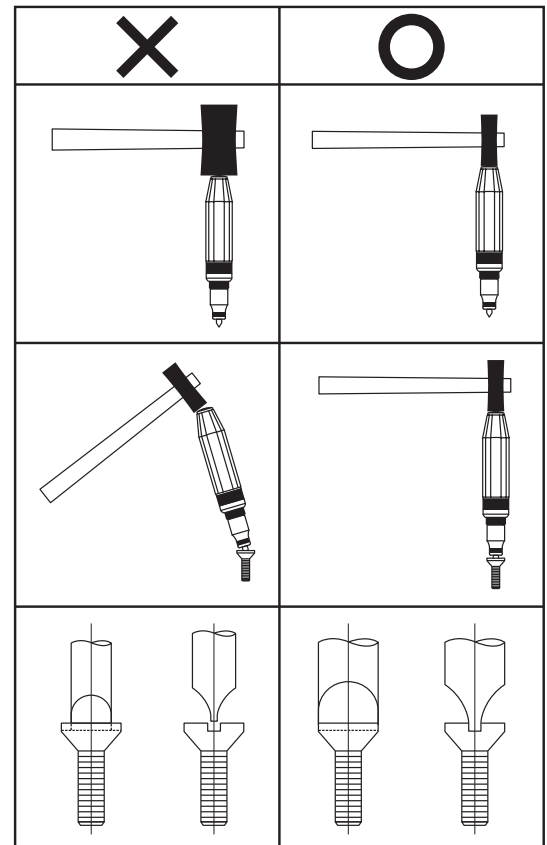

HAND  
MANUALES

Z-SERIES

TITANIUM  
DE TITANIO

ACCESSORIES  
ACCESORIOS

SCREWDRIVERS  
DESTORNILLADORES

IMPACT  
DE IMPACTO



SLEEVE-DRIVE



INDUSTRIAL  
INDUSTRIALES



AUTOMOTIVE



CONSTRUCTION  
CONSTRUCCION



RENEWAL KITS  
JUEGOS DE PIEZAS REPUESTO



<b>AN318A</b> 6 Pieces Set/🔧=1,070g	
METAL CASE:W190xH59xT45mm	
Bits	Accessories
➕ <b>100P.32</b> Phillips Bits 2, 3	 <b>3112N</b>
➖ <b>100S.32</b> Slotted Bits 9, 11	 <b>3138</b>



<b>AN112A</b> 6 Pieces Set/🔧=1,070g	
METAL CASE:W190xH59xT45mm	
Bits	Accessories
➕ <b>100P.32</b> Phillips Bits 2, 3	 <b>4112N</b>
➖ <b>100S.32</b> Slotted Bits 9, 11	 <b>4138</b>

<b>AG318A</b> 6 Pieces Set/🔧=1,150g	
METAL CASE:W220xH82xT60mm	
Bits	Accessories
➕ <b>100P.32</b> Phillips Bits 2, 3	 <b>3112G</b>
➖ <b>100S.32</b> Slotted Bits 9, 11	 <b>3138</b>

<b>AG112A</b> 6 Pieces Set/🔧=1,150g	
METAL CASE:W220xH82xT60mm	
Bits	Accessories
➕ <b>100P.32</b> Phillips Bits 2, 3	 <b>4112G</b>
➖ <b>100S.32</b> Slotted Bits 9, 11	 <b>4138</b>

<b>AN112C</b> 8 Pieces Set/🔧=1,350g	
METAL CASE:W215xH80xT47mm	
Bits	Accessories
➕ <b>100P.80</b> Phillips Bits 1, 2, 3	 <b>4112N</b>
➖ <b>100S.80</b> Slotted Bits 7, 9, 12	 <b>4138</b>

<b>AG112F</b> 25 Pieces Set/🔧=1,530g	
METAL CASE:W220xH82xT60mm	
Bits	Accessories
➕ <b>100P.32</b> Phillips Bits 2, 3	 <b>4112G</b>
➕ <b>100P.32</b> PZ Bits PZ2, PZ3	
➖ <b>100S.32</b> Slotted Bits 9, 11	 <b>4138</b>
➕ <b>100H.32</b> Hex Bits 4, 5, 6, 7, 8, 10	
➕ <b>100T.32</b> TORX® Bits T25, T27, T30, T40, T45, T50	
➕ <b>100X.32</b> XZN Bits M5, M6, M8, M10, M12	

<b>AG112H</b> 18 Pieces Set/🔧=1,480g	
METAL CASE:W220xH82xT60mm	
Bits	Accessories
➕ <b>100P.32</b> Phillips Bits 2, 3, 4	 <b>4112G</b>
➖ <b>100S.32</b> Slotted Bits 8, 9, 10, 12, 14	
➕ <b>100H.32</b> Hex Bits 5, 6, 8, 10	 <b>4138</b>
➕ <b>100T.32</b> TORX® Bits T30, T40, T45, T50	

**AN318A** Attack Driver Set  
Juego de Destornilladores de Impacto

**AN112A**



**AG318A** Attack Driver Set  
Juego de Destornilladores de Impacto

**AG112A**



**AN112C** Attack Driver Set  
Juego de Destornilladores de Impacto



**AG112F** Attack Driver Set  
Juego de Destornilladores de Impacto



**AG112H** Attack Driver Set  
Juego de Destornilladores de Impacto



HAND MANUALES  
Z-SERIES  
TITANIUM DE TITANIO  
ACCESSORIES ACCESORIOS  
SCREWDRIVERS DESTORNILLADORES  
IMPACT DE IMPACTO  
SLEEVE-DRIVE  
INDUSTRIAL INDUSTRIALES  
AUTOMOTIVE  
CONSTRUCTION CONSTRUCCION  
RENEWAL KITS JUEGOS DE PIEZAS REPLÉSTO

**108P-25 · -32 · -50**  Phillips Bits  
Puntas Phillips



108P.25 (PH)	D (mm)	L (mm)	(g)	(pcs.)
1	6.35	25	5	10
2	6.35	25	5	10
3	6.35	25	6	10

108P.32 (PH)	D (mm)	L (mm)	(g)	(pcs.)
1	6.35	32	7	10
2	6.35	32	7	10
3	6.35	32	8	10

108P.50 (PH)	D (mm)	L (mm)	(g)	(pcs.)
1	6.35	50	10	10
2	6.35	50	11	10
3	6.35	50	11	10

**108S-25 · -39**  Bits for Slotted head  
Puntas Rectas/Planas

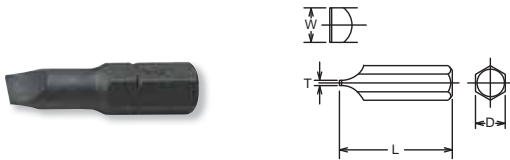

108S.25	TxW (mm)	D (mm)	L (mm)	(g)	(pcs.)
3	0.5x3	6.35	25	3	10
4	0.6x4	6.35	25	3	10
4.5	0.6x4.5	6.35	25	4	10
5	0.8x5	6.35	25	5	10
5.5	0.8x5.5	6.35	25	5	10
6	1.0x6	6.35	25	5	10
8	1.2x8	6.35	25	6	10

108S.39	TxW (mm)	D (mm)	L (mm)	(g)	(pcs.)
3	0.5x3	6.35	39	6	10
4	0.6x4	6.35	39	6	10
4.5	0.6x4.5	6.35	39	6	10
5	0.8x5	6.35	39	7	10
5.5	0.8x5.5	6.35	39	8	10
6	1.0x6	6.35	39	9	10
8	1.2x8	6.35	39	12	10

**108H-25**  Hex Bits  
Puntas Hexagonales

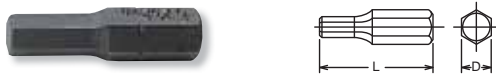

108H.25 (mm)	D (mm)	L (mm)	(g)	(pcs.)
3	6.35	25	4	10
4	6.35	25	5	10
5	6.35	25	5	10
6	6.35	25	6	10
7	6.35	25	7	10
8	6.35	25	8	10
10	6.35	25	11	10

108H.25 (inch)	D (mm)	L (mm)	(g)	(pcs.)
1/8	6.35	25	4	10
9/64	6.35	25	5	10
3/16	6.35	25	5	10
7/32	6.35	25	6	10
1/4	6.35	25	7	10

**108T-25 (T)**  TORX® Bits  
Puntas TORX®



108T.25 (T)	D (mm)	L (mm)	(g)	(pcs.)
T10	6.35	25	4	10
T15	6.35	25	4	10
T20	6.35	25	5	10
T25	6.35	25	6	10
T27	6.35	25	6	10
T30	6.35	25	6	10
<b>New</b> T40	6.35	25	6	10

**108T-25 (TH)**  Tamper-Resistant TORX® Bits  
Punta TORX®, indeformable 



108T.25 (TH)	D (mm)	L (mm)	(g)	(pcs.)
T10H	6.35	25	4	10
T15H	6.35	25	4	10
T20H	6.35	25	5	10
T25H	6.35	25	6	10
T27H	6.35	25	6	10
T30H	6.35	25	6	10
<b>New</b> T40H	6.35	25	6	10

 Tamper Resistant TORX® Bits have less strength due to special design. Make sure to use it correctly.

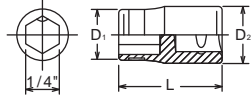

	□	D <sub>1</sub> (mm)	D <sub>2</sub> (mm)	L (mm)	⚖️ (g)	📦 (pcs.)
2137	1/4"	12	12	22.5	13	10
3137	3/8"	13	16.5	30	30	10
4137	1/2"	13	22	38	53	10

**2137** ○ Bit Holder Porta-punta



**3137** ○ Bit Holder Porta-punta



**4137** ○ Bit Holder Porta-punta

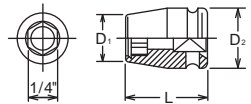

	□	D <sub>1</sub> (mm)	D <sub>2</sub> (mm)	L (mm)	⚖️ (g)	📦 (pcs.)	⚡
12139-1/4	1/4"	11	13	26	15	10	*1
13139-1/4	3/8"	11	19	30	32	10	*2
14139-1/4	1/2"	11	25	38	62	10	*3

\*1 Pin/O-Ring=1200A/B  
\*2 C-Ring=1301C,Pin/O-Ring=1301A/B  
\*3 C-Ring=1401C,Pin/O-Ring=1401A/B → P232-233

**12139** ○ Impact Bit Holder Porta-punta de Impacto



**13139** ○ Impact Bit Holder Porta-punta de Impacto



**14139** ○ Impact Bit Holder Porta-punta de Impacto



**Lock & Quick Release**

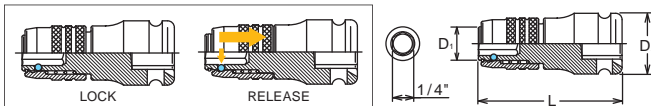

	□	D <sub>1</sub> (mm)	D <sub>2</sub> (mm)	L (mm)	⚖️ (g)	📦 (pcs.)	⚡
13142-D6.3	3/8"	16	19	45	60	10	*1
14142-D6.3	1/2"	16	25	55	97	10	*2

\*1 C-Ring=1301C,Pin/O-Ring=1301A/B  
\*2 C-Ring=1401C,Pin/O-Ring=1401A/B → P232-233

**13142-D6.3** ○ Impact Bit Holder for 1/4" (6.3) Bits  
Porta-punta de Impacto para Puntas 1/4" (6.3)

**14142-D6.3** ○

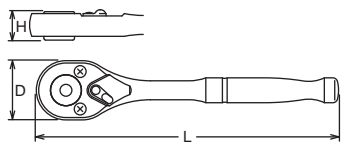

	D (mm)	H (mm)	L (mm)	⚖️ (g)	📦 (pcs.)
2749P-1/4HF	25	12	125	96	10
2774P-1/4HF	25	12	165	133	2

**2749P-1/4HF** ○ Reversible Ratchet, for Bits 1/4"  
Llave de Carraca Reversible, para Puntas 1/4"



**2774P-1/4HF** ○ Flexible Ratchet, reversible, for Bits 1/4"  
Llave de Carraca Reversible, para Puntas 1/4"





HAND  
MANUALES

Z-SERIES

TITANIUM  
DE TITANIO

ACCESSORIES  
ACCESORIOS

SCREWDRIVERS  
DESTORNILLADORES

IMPACT  
DE IMPACTO

SLEEVE-DRIVE

INDUSTRIAL  
INDUSTRIALES

AUTOMOTIVE

CONSTRUCTION  
CONSTRUCCIÓN

RENEWAL KITS  
JUEGOS DE PIEZAS/REPLÉSTO

## 100P-32 · -80 · -125

Phillips Bits  
Puntas Phillips

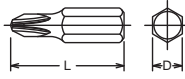

100P.80 (PH)	D (mm)	L (mm)	(g)	(pcs.)
1	8	80	30	10
2	8	80	30	10
3	8	80	31	10
4	8	80	32	10

100P.32 (PH)	D (mm)	L (mm)	(g)	(pcs.)
1	8	32	11	10
2	8	32	11	10
3	8	32	12	10
4	8	32	12	10

100P.125 (PH)	D (mm)	L (mm)	(g)	(pcs.)
2	8	125	48	10
3	8	125	49	10

## 100P-32 (PZ)

PZ Bits  
Puntas PZ

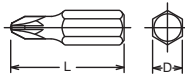

100P.32 (PZ)	D (mm)	L (mm)	(g)	(pcs.)
PZ2	8	32	10	10
PZ3	8	32	11	10

## 100S-32 · -80

Bits for Slotted head  
Puntas Rectas/Planas

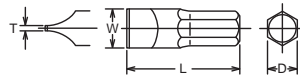

100S.32	T×W (mm)	D (mm)	L (mm)	(g)	(pcs.)
6	1 × 6	8	32	10	10
7	1 × 7	8	32	11	10
8	1.2× 8	8	32	12	10
9	1.6× 9	8	32	12	10
10	1.6×10	8	32	13	10
11	1.6×11	8	32	15	10
12	2 ×12	8	32	18	10
14	2 ×14	8	32	21	10

100S.80	T×W (mm)	D (mm)	L (mm)	(g)	(pcs.)
6	1 × 6	8	80	29	10
7	1 × 7	8	80	30	10
8	1.2× 8	8	80	31	10
9	1.6× 9	8	80	32	10
10	1.6×10	8	80	33	10
11	1.6×11	8	80	33	10
12	2 ×12	8	80	34	10
14	2 ×14	8	80	37	10

## 100H-32

Hex Bits  
Puntas Hexagonales

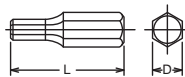

100H.32 (mm)	D (mm)	L (mm)	(g)	(pcs.)
3	8	32	11	10
4	8	32	11	10
5	8	32	12	10
6	8	32	12	10
7	8	32	13	10
8	8	32	13	10
10	8	32	16	10
12	8	32	23	10
14	8	32	29	10

## 100X-32 (XZN)

XZN Bits  
Puntas XZN

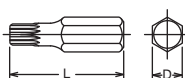

100X.32 (XZN)	D (mm)	L (mm)	(g)	(pcs.)
M 5	8	32	10	10
M 6	8	32	11	10
M 8	8	32	12	10
M10	8	32	16	10
M12	8	32	19	10

## 100T-32 (T)

TORX® Bits  
Puntas TORX®

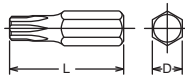

100T.32 (T)	D (mm)	L (mm)	(g)	(pcs.)
T10	8	32	9	10
T15	8	32	9	10
T20	8	32	9	10
T25	8	32	10	10
T27	8	32	10	10
T30	8	32	11	10
T40	8	32	12	10
T45	8	32	12	10
T50	8	32	12	10
T55	8	32	12	10

## 100T-32 (TH)

Tamper-Resistant TORX® Bits  
Punta TORX®, indeformable

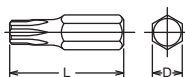

100T.32 (TH)	D (mm)	L (mm)	(g)	(pcs.)
T10H	8	32	9	10
T15H	8	32	9	10
T20H	8	32	9	10
T25H	8	32	10	10
T27H	8	32	10	10
T30H	8	32	11	10
T40H	8	32	12	10
T45H	8	32	12	10
T50H	8	32	12	10
T55H	8	32	12	10

⚠ Tamper Resistant TORX® Bits have less strength due to special design. Make sure to use it correctly.

**2138**  Bit Holder  
Porta-punta





**3138**  Bit Holder  
Porta-punta

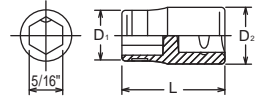

**4138**  Bit Holder  
Porta-punta



		D <sub>1</sub> (mm)	D <sub>2</sub> (mm)	L (mm)	 (g)	 (pcs.)
<b>2138</b>	1/4"	16	16	26	32	10
<b>3138</b>	3/8"	16	18	38	55	10
<b>4138</b>	1/2"	16	22	38	62	10

**12140**  Impact Bit Holder  
Porta-punta de Impacto







**13140**  Impact Bit Holder  
Porta-punta de Impacto

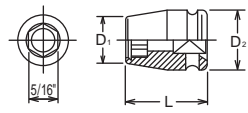

**14140**  Impact Bit Holder  
Porta-punta de Impacto



		D <sub>1</sub> (mm)	D <sub>2</sub> (mm)	L (mm)	 (g)	 (pcs.)	
<b>12140-5/16</b>	1/4"	14	13	26	15	10	*1
<b>13140-5/16</b>	3/8"	14	19	30	32	10	*2
<b>14140-5/16</b>	1/2"	14	25	38	62	10	*3

\*1 Pin/O-Ring=1200A/B

\*2 C-Ring=1301C,Pin/O-Ring=1301A/B

\*3 C-Ring=1401C,Pin/O-Ring=1401A/B

[→ P232-233](#)

**2749P-5/16HF**  Reversible Ratchet, for Bits 5/16"  
Llave de Carraca Reversible, para Puntas 5/16"



**2774P-5/16HF**  Flexible Ratchet, reversible, for Bits 5/16"  
Llave de Carraca Reversible, para Puntas 5/16"

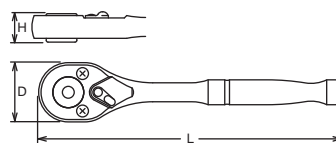



	D (mm)	H (mm)	L (mm)	 (g)	 (pcs.)
<b>2749P-5/16HF</b>	25	14	125	96	10
<b>2774P-5/16HF</b>	25	14	165	133	2

# Double ended Bits **5/16"**

HAND MANUALES  
Z-SERIES  
TITANIUM DE TITANIO  
ACCESSORIES ACCESORIOS  
SCREWDRIVERS DESTORNILLADORES  
IMPACT DE IMPACTO  
SLEEVE-DRIVE  
INDUSTRIAL INDUSTRIALES  
AUTOMOTIVE  
CONSTRUCTION CONSTRUCCION  
RENEWAL KITS JUEGOS DE PIEZAS/REPLISTO

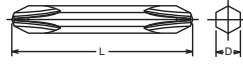
## 131P-80 Phillips Bits Puntas Phillips



131P.80		D (mm)	L (mm)	(g)	(pcs.)
1	No.1xNo.2	8	80	28	10
2	No.2xNo.3	8	80	29	10
3	No.3xNo.3	8	80	29	10

## 131S-80 Bits for Slotted heads Puntas Rectas/Planas

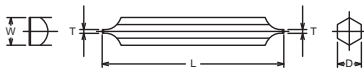

131S.80	TxW (mm)	D (mm)	L (mm)	(g)	(pcs.)
6	1.0x6	8	80	29	10
7	1.0x7	8	80	29	10
8	1.2x8	8	80	30	10
9	1.6x9	8	80	31	10

## 131PS-80 Double Ended Bits Puntas



131PS.80		D (mm)	L (mm)	(g)	(pcs.)
2	No.2xNo.6	8	80	29	10
3	No.3xNo.8	8	80	29	10

## 131T-80 TORX® Bits Puntas TORX®

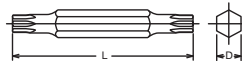

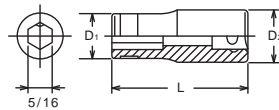

131T.80 (T)	D (mm)	L (mm)	(g)	(pcs.)
T10xT15	8	80	27	10
T20xT25	8	80	27	10
T27xT30	8	80	28	10

## 3141 Bit Holder, extra deep for 131P-80, 131S-80, 131T-80 Porta-punta, extra-largo para 131P-80, 131S-80, 131T-80

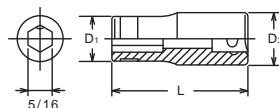

## 4141 Bit Holder, extra deep for 131P-80, 131S-80, 131T-80 Porta-punta, extra-largo para 131P-80, 131S-80, 131T-80



		D <sub>1</sub> (mm)	D <sub>2</sub> (mm)	L (mm)	(g)	(pcs.)
3141	<b>3/8"</b>	16	18	48	60	10
4141	<b>1/2"</b>	16	22	52	70	10

HAND MANUALES  
Z-SERIES  
TITANIUM DE TITANIO  
ACCESSORIES ACCESORIOS  
SCREWDRIVERS DESTORNILLADORES  
IMPACT DE IMPACTO  
SLEEVE-DRIVE INDUSTRIAL INDUSTRIALES  
AUTOMOTIVE  
CONSTRUCTION CONSTRUCCION  
RENEWAL KITS JUEGOS DEPIEZAS REPUESTO

110		TYPE	L (mm)	(g)	(pcs.)
35B	1/4"	Ball	35	9	10
35P		Pin	35	9	10
50B		Ball	50	15	10
50P		Pin	50	15	10
100B		Ball	100	34	10
100P		Pin	100	34	10
150B		Ball	150	54	10
150P		Pin	150	54	10

● DIN 3126 Form E 6.3

112		TYPE	L (mm)	(g)	(pcs.)
50B	3/8"	Ball	50	21	10
50P		Pin	50	21	10
100B		Ball	100	71	10
100P		Pin	100	71	10
150B		Ball	150	121	10
150P		Pin	150	121	10

● DIN 3126 Form E 6.3



135E		TYPE	L (mm)	(g)	(pcs.)
60B	1/2"	Ball	60	46	10
60P		Pin	60	46	10

● DIN 3126 Form E 6.3

117		TYPE	L (mm)	(g)	(pcs.)
50B	1/4"	Ball	50	15	10
50P		Pin	50	15	10
100B		Ball	100	71	10
100P		Pin	100	71	10

● DIN 3126 Form G7

120		TYPE	L (mm)	(g)	(pcs.)
50B	3/8"	Ball	50	27	10
50P		Pin	50	27	10

● DIN 3126 Form E8

186-75P		D (mm)	(g)	(pcs.)
3/8	3/8"	75	65	10
1/2	1/2"	75	85	10

● DIN 3126 Form E11.2

BD022-120P		D (mm)	(g)	(pcs.)
3/8	3/8"	120	100	10
1/2	1/2"	120	160	10

110-35B · -50B · -100B · -150B  
-35P · -50P · -100P · -150P

Adaptors Adaptadores

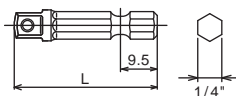

112-50B · -100B · -150B  
-50P · -100P · -150P

Adaptors Adaptadores

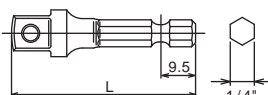

135E-60B · -60P

Adaptors Adaptadores

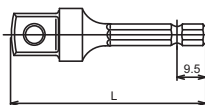

117-50B · -100B  
-50P · -100P

Adaptors Adaptadores



120-50B · -50P

Adaptors Adaptadores



186-75P

Adaptors with Pin Adaptadores con Perno

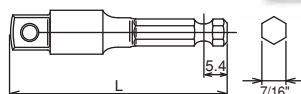

BD022-120P

Hammer Drill Adaptor Adaptador para Taladro de Percusión

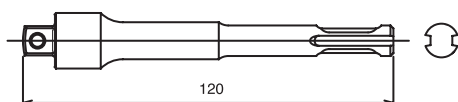

HAND MANUALES  
Z-SERIES  
TITANIUM DE TITANIO  
ACCESSORIES ACCESORIOS  
SCREWDRIVERS DESTORNILLADORES  
IMPACT DE IMPACTO  
SLEEVE-DRIVE  
INDUSTRIAL INDUSTRIALES  
AUTOMOTIVE  
CONSTRUCTION CONSTRUCCION  
RENEWAL KITS JUEGOS DE PIEZAS REPLISTO

**121P-50 · -70 · -100 · -150**  Phillips Bits  
Puntas Phillips

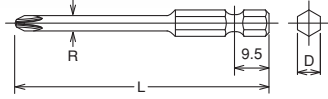

121P.50 (PH)	D (mm)	R (mm)	L (mm)	(g)	(pcs.)
1	6.35	4.5	50	12	10
2	6.35	5.5	50	12	10
3	6.35	-	50	13	10

**121H-50 · -70 · -100 · -150**  Hex Bits  
Puntas Hexagonales

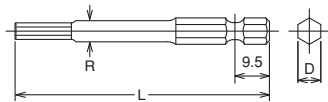

121H.50 (mm)	D (mm)	R (mm)	L (mm)	(g)	(pcs.)
3	6.35	3.5	50	12	10
4	6.35	4.5	50	12	10
5	6.35	5.6	50	13	10
6	6.35	-	50	14	10

**121T-50 · -70 · -100 · -150 (T)**  TORX® Bits  
Puntas TORX®

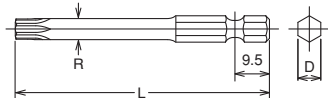

121T.50 (T)	D (mm)	R (mm)	L (mm)	(g)	(pcs.)
<b>New</b> T15	6.35	3.5	50	12	10
T20	6.35	4.1	50	12	10
T25	6.35	4.6	50	12	10
T27	6.35	5.2	50	13	10
T30	6.35	5.7	50	13	10
T40	6.35	-	50	14	10

**121T-70 · -100 (TH)**  Tamper-Resistant TORX® Bits  
Punta TORX®, indeformable 

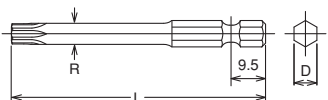

121P.70 (PH)	D (mm)	R (mm)	L (mm)	(g)	(pcs.)
1	6.35	4.5	70	15	10
2	6.35	5.5	70	15	10
3	6.35	-	70	16	10

121P.100 (PH)	D (mm)	R (mm)	L (mm)	(g)	(pcs.)
1	6.35	4.5	100	23	10
2	6.35	5.5	100	23	10
3	6.35	-	100	24	10

121P.150 (PH)	D (mm)	R (mm)	L (mm)	(g)	(pcs.)
<b>New</b> 1	6.35	4.5	150	30	10
<b>New</b> 2	6.35	5.5	150	35	10
<b>New</b> 3	6.35	-	150	36	10

121H.70 (mm)	D (mm)	R (mm)	L (mm)	(g)	(pcs.)
3	6.35	4.0	70	15	10
4	6.35	4.5	70	15	10
5	6.35	5.6	70	16	10
6	6.35	-	70	18	10

121H.100 (mm)	D (mm)	R (mm)	L (mm)	(g)	(pcs.)
3	6.35	4.0	100	23	10
4	6.35	4.5	100	23	10
5	6.35	5.6	100	24	10
6	6.35	-	100	26	10

121H.150 (mm)	D (mm)	R (mm)	L (mm)	(g)	(pcs.)
3	6.35	4.5	150	37	10
4	6.35	5.0	150	37	10
5	6.35	6.0	150	38	10
6	6.35	-	150	39	10

121T.70 (T)	D (mm)	R (mm)	L (mm)	(g)	(pcs.)
<b>New</b> T15	6.35	3.5	70	16	10
T20	6.35	4.1	70	16	10
T25	6.35	4.6	70	16	10
T27	6.35	5.2	70	17	10
T30	6.35	5.7	70	17	10
T40	6.35	-	70	18	10

121T.100 (T)	D (mm)	R (mm)	L (mm)	(g)	(pcs.)
<b>New</b> T15	6.35	4.0	100	24	10
T20	6.35	4.1	100	24	10
T25	6.35	4.6	100	24	10
T27	6.35	5.2	100	24	10
T30	6.35	5.7	100	25	10
T40	6.35	-	100	26	10

121T.150 (T)	D (mm)	R (mm)	L (mm)	(g)	(pcs.)
<b>New</b> T15	6.35	4.0	150	37	10
T20	6.35	4.5	150	37	10
T25	6.35	5.0	150	37	10
T27	6.35	5.6	150	37	10
T30	6.35	6.0	150	38	10
T40	6.35	-	150	39	10

121T.70 (TH)	D (mm)	R (mm)	L (mm)	(g)	(pcs.)
T20H	6.35	4.1	70	16	10
T25H	6.35	4.6	70	16	10
T27H	6.35	5.2	70	17	10
T30H	6.35	5.7	70	17	10
T40H	6.35	-	70	18	10

121T.100 (TH)	D (mm)	R (mm)	L (mm)	(g)	(pcs.)
<b>New</b> T20H	6.35	4.1	100	24	10
<b>New</b> T25H	6.35	4.6	100	24	10
<b>New</b> T27H	6.35	5.2	100	24	10
<b>New</b> T30H	6.35	5.7	100	25	10
<b>New</b> T40H	6.35	-	100	26	10

 Tamper Resistant TORX® Bits have less strength due to special design. Make sure to use it correctly.



123PT (PH)	D (mm)	L (mm)	(g)	(pcs.)
2	6.35	75	18	10
2	6.35	100	24	10

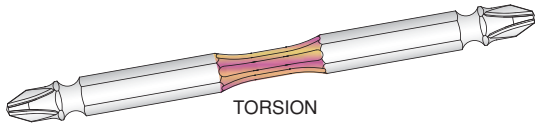

123PN.75 123PG.75 (PH)	D (mm)	L (mm)	(g)	(pcs.)
1	6.35	75	16	10
2	6.35	75	16	10
3	6.35	75	17	10

123PN.100 123PG.100 (PH)	D (mm)	L (mm)	(g)	(pcs.)
1	6.35	100	23	10
2	6.35	100	23	10
3	6.35	100	24	10

165LM.45 (mm)	D (mm)	(mm)	L (mm)	(g)	(pcs.)
8	13.5	3.5	45	55	10
10	16	4.2	45	58	10
12	18.5	5.6	45	65	10
14	21	6.4	45	70	10

Slide the socket by pulling holder, and pull back the socket to lock on the bit groove.  
Ring magnet holds a bolt or nut for easy work.



Nut Setter



Phillips Bit

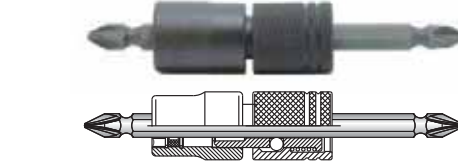

	□	D <sub>1</sub> (mm)	D <sub>2</sub> (mm)	L (mm)	(g)	(pcs.)	⊖
12137E	1/4"	12	13	40	22	10	*1
13137H	3/8"	22.5	19	42	77	10	*2
13137E	3/8"	12	19	40	40	10	*2
14137E	1/2"	12	25	48	70	10	*3

\*1 Pin/O-Ring=1200A/B

\*2 C-Ring=1301C, Pin/O-Ring=1301A/B → P232-233

\*3 C-Ring=1401C, Pin/O-Ring=1401A/B

Lock & Quick Release

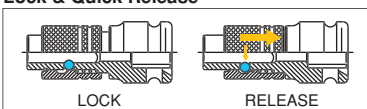

	□	D <sub>1</sub> (mm)	D <sub>2</sub> (mm)	L (mm)	(g)	(pcs.)	⊖
New 12142-F6.3	1/4"	16.5	13	36	22	10	*1
13142-F6.3	3/8"	16.5	19	45	60	10	*2
14142-F6.3	1/2"	16.5	25	55	100	10	*3

\*1 Pin/O-Ring=1200A/B

\*2 C-Ring=1301C, Pin/O-Ring=1301A/B → P232-233

\*3 C-Ring=1401C, Pin/O-Ring=1401A/B

123PT-75 • -100

⊕ Double ended Torsion Bits  
Puntas Phillips, simétricas, Torsion

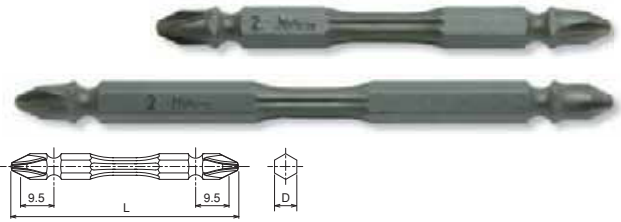

123PN-75 • -100

⊕ Double ended Bits  
Puntas Phillips, simétricas

123PG-75 • -100

⊕ Magnetic type

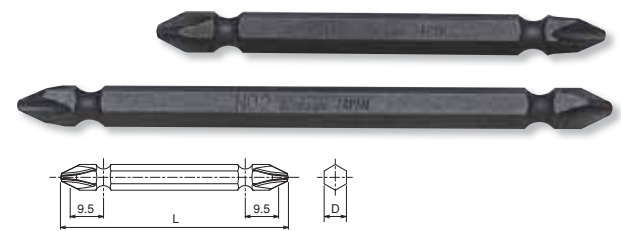

165LM

⊖ Slide socket with Magnet



13137H

⊖ Impact Bit Holder for 1/4"(6.3) Bits  
Porta-punta de impacto para Puntas 1/4"(6.3)

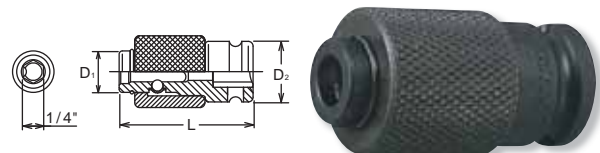

12137E

⊖ Impact Bit Holder for 1/4"(6.3) Bits  
Porta-punta de impacto para Puntas 1/4"(6.3)

13137E

14137E

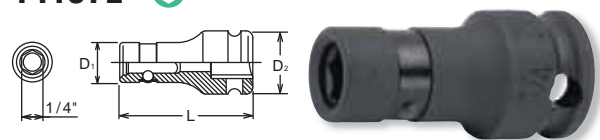

12142-F6.3

⊖ Impact Bit Holder for 1/4"(6.3) Bits  
Porta-punta de impacto para Puntas 1/4"(6.3)

13142-F6.3

14142-F6.3

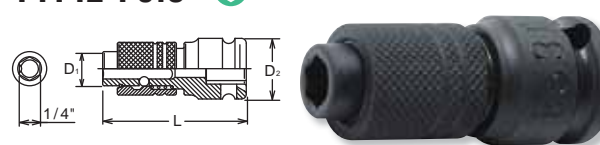

HAND MANUALES  
Z-SERIES  
TITANIUM DE TITANIO  
ACCESSORIES ACCESORIOS  
SCREWDRIVERS DESTORNILLADORES  
IMPACT DE IMPACTO  
SLEEVE-DRIVE INDUSTRIAL INDUSTRIALES  
AUTOMOTIVE  
CONSTRUCTION CONSTRUCCION  
RENEWAL KITS JUEGOS DE PIZAS REPUESTO

HAND MANUALES  
Z-SERIES  
TITANIUM DE TITANIO  
ACCESSORIES ACCESORIOS  
SCREWDRIVERS DESTORNILLADORES  
IMPACT DE IMPACTO  
SLEEVE-DRIVE  
INDUSTRIAL INDUSTRIALES  
AUTOMOTIVE  
CONSTRUCTION CONSTRUCCION  
RENEWAL KITS JUEGOS DE PIEZAS REPLUSTO

**113-50**  Nut Setters  
Vasos para apretar tuercas Hexagonales

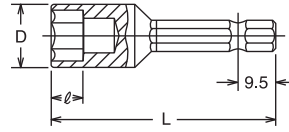

113.50 (mm)	D (mm)	(mm)	L (mm)	(g)	(pcs.)
5.5	9	4	50	15	10
6	10	5	50	17	10
7	11	5	50	19	10
8	12	6	50	20	10
10	14	7	50	31	10
12	17	8	50	39	10
13	18	8	50	42	10
14	19	9	50	46	10

113.50 (inch)	D (mm)	(mm)	L (mm)	(g)	(pcs.)
1/4	10	5	50	17	10
5/16	12	6	50	20	10
3/8	14	7	50	31	10
1/2	18	8	50	42	10

**113-75 • -100 • -150 • -200 • -250**  Nut Setters  
Vasos para apretar tuercas Hexagonales

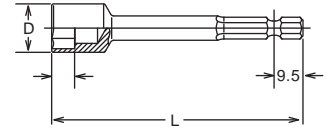

113.75 (mm)	D (mm)	(mm)	L (mm)	(g)	(pcs.)
7	11.5	5	75	31	10
8	12.7	6	75	32	10
10	14.5	7	75	35	10
12	17	8	75	42	10
13	18	8	75	41	10
14	19	9	75	43	10

113.100 (mm)	D (mm)	(mm)	L (mm)	(g)	(pcs.)
7	11.5	5	100	40	10
8	12.7	6	100	41	10
10	14.5	7	100	45	10
12	17	8	100	52	10
13	18	8	100	51	10
14	19	9	100	53	10

113.150 (mm)	D (mm)	(mm)	L (mm)	(g)	(pcs.)
7	11.5	5	150	59	10
8	12.7	6	150	60	10
10	14.5	7	150	64	10
12	17	8	150	70	10
13	18	8	150	76	10
14	19	9	150	78	10

113.200 (mm)	D (mm)	(mm)	L (mm)	(g)	(pcs.)
7	11.5	5	200	78	10
8	12.7	6	200	79	10
10	14.5	7	200	83	10
12	17	8	200	91	10
13	18	8	200	93	10
14	19	9	200	95	10

113.250 (mm)	D (mm)	(mm)	L (mm)	(g)	(pcs.)
7	11.5	5	250	99	10
8	12.7	6	250	100	10
10	14.5	7	250	105	10
12	17	8	250	113	10
13	18	8	250	114	10
14	19	9	250	119	10

**113-50 (E)**  Nut Setters, TORX®  
Vasos para apretar tuercas, TORX®

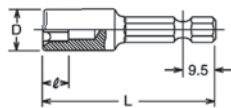

113.50 (E)	D (mm)	(mm)	L (mm)	(g)	(pcs.)
E 4	6.1	4.5	50	12	10
E 5	7.5	4.5	50	15	10
E 6	8.3	5.0	50	17	10
E 7	8.8	5.8	50	18	10
E 8	10.1	6.6	50	19	10
E10	12	7.4	50	20	10

**113-50 (2B)**  Nut Setters Nut Grip®  
Vasos para apretar tuercas con 2 bolas

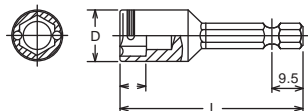

113.50 (mm)	D (mm)	(mm)	L (mm)	(g)	(pcs.)
7(2B)	11	5	50	20	10
8(2B)	12	6	50	21	10
10(2B)	14.2	7	50	26	10
13(2B)	18	8	50	31	10

113.50 (inch)	D (mm)	(mm)	L (mm)	(g)	(pcs.)
3/8(2B)	14.2	7	50	26	10

## 115-50 Nut Setters with Magnet Vasos para tuercas con Imán

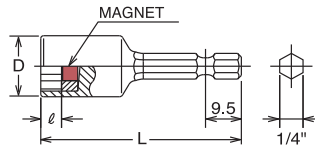

115.50 (mm)	D (mm)	(mm)	L (mm)	(g)	(pcs.)
5.5	9	2.1	50	15	10
6	10	2.4	50	17	10
7	11	2.8	50	19	10
8	12	3.5	50	20	10
10	14	4.2	50	29	10
12	17	5.6	50	40	10
13	18	6	50	50	10
14	19	6.4	50	60	10

115.50 (inch)	D (mm)	(mm)	L (mm)	(g)	(pcs.)
1/4	10	1.8	50	17	10
1/4(DP2.4)	10	2.4	50	17	10
5/16	12	3.5	50	20	10
3/8	14	4.2	50	29	10
1/2	18	6	50	50	10

## 115-75 · -100 · -150 · -200 · -250

 Nut Setters with Magnet  
Vasos para tuercas con Imán

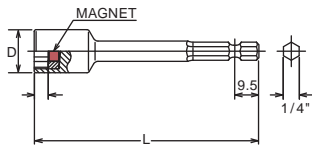

115.75 (mm)	D (mm)	(mm)	L (mm)	(g)	(pcs.)
7	11.5	2.8	75	32	10
8	12.7	3.5	75	33	10
10	14.5	4.2	75	38	10
12	17	5.6	75	46	10
13	18	6	75	49	10
14	19	6.4	75	52	10

115.100 (mm)	D (mm)	(mm)	L (mm)	(g)	(pcs.)
7	11.5	2.8	100	41	10
8	12.7	3.5	100	42	10
10	14.5	4.2	100	50	10
12	17	5.6	100	58	10
13	18	6	100	62	10
14	19	6.4	100	65	10

115.150 (mm)	D (mm)	(mm)	L (mm)	(g)	(pcs.)
7	11.5	2.8	150	60	10
8	12.7	3.5	150	61	10
10	14.5	4.2	150	68	10
12	17	5.6	150	77	10
13	18	6	150	82	10
14	19	6.4	150	85	10

115.200 (mm)	D (mm)	(mm)	L (mm)	(g)	(pcs.)
7	11.5	2.8	200	79	10
8	12.7	3.5	200	80	10
10	14.5	4.2	200	88	10
12	17	5.6	200	97	10
13	18	6	200	102	10
14	19	6.4	200	105	10

115.250 (mm)	D (mm)	(mm)	L (mm)	(g)	(pcs.)
7	11.5	2.8	250	101	10
8	12.7	3.5	250	103	10
10	14.5	4.2	250	110	10
12	17	5.6	250	118	10
13	18	6	250	122	10
14	19	6.4	250	124	10



HAND  
MANUALES  
Z-SERIES  
TITANIUM  
DE TITANIO  
ACCESSORIES  
ACCESORIOS  
SCREWDRIVERS  
DESTORNILLADORES  
IMPACT  
DE IMPACTO  
SLEEVE-DRIVE  
INDUSTRIAL  
INDUSTRIALES  
AUTOMOTIVE  
CONSTRUCTION  
CONSTRUCCION  
RENEWAL KITS  
JUEGOS DE PIEZAS REPUESTO

HAND MANUALES  
Z-SERIES  
TITANIUM DE TITANIO  
ACCESSORIES ACCESORIOS  
SCREWDRIVERS DESTORNILLADORES  
IMPACT DE IMPACTO  
SLEEVE-DRIVE  
INDUSTRIAL INDUSTRIALES  
AUTOMOTIVE  
CONSTRUCTION CONSTRUCCIÓN  
RENEWAL KITS JUEGOS DE PIEZAS REPLUSTO

### 113UN-100 • -150 • -200

6-point Universal Joint Nut Setters  
Vasos para apretar tuercas Hexagonales con Articulación Universal

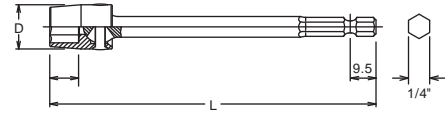

113UN.100 (mm)	D (mm)	(mm)	L (mm)	(g)	(pcs.)
8	13	7	100	50	10
10	15	8	100	53	10
12	17	10	100	56	10
13	18	10	100	65	10
14	19.2	10	100	67	10

113UN.150 (mm)	D (mm)	(mm)	L (mm)	(g)	(pcs.)
8	13	7	150	65	10
10	15	8	150	70	10
12	17	10	150	77	10
13	18	10	150	92	10
14	19.2	10	150	92	10

113UN.200 (mm)	D (mm)	(mm)	L (mm)	(g)	(pcs.)
8	13	7	200	75	10
10	15	8	200	87	10
12	17	10	200	98	10
13	18	10	200	116	10
14	19.2	10	200	116	10

### 115G-75 • -100 • -150 • -200

Nut Setters with sliding Magnet  
Vasos para tuercas con Imán Corredizo

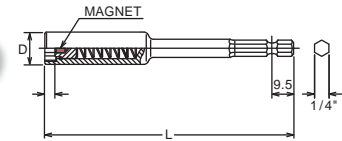

115G.75 (mm)	D (mm)	(mm)	L (mm)	(g)	(pcs.)
7	11.5	3.5	75	34	10
8	12.7	4	75	41	10
10	14.5	4.5	75	48	10
12	17	6	75	65	10
13	18	6.5	75	70	10
14	19	7	75	73	10

115G.100 (mm)	D (mm)	(mm)	L (mm)	(g)	(pcs.)
7	11.5	3.5	100	51	10
8	12.7	4	100	51	10
10	14.5	4.5	100	57	10
12	17	6	100	77	10
13	18	6.5	100	80	10
14	19	7	100	82	10

115G.150 (mm)	D (mm)	(mm)	L (mm)	(g)	(pcs.)
7	11.5	3.5	150	67	10
8	12.7	4	150	70	10
10	14.5	4.5	150	77	10
12	17	6	150	95	10
13	18	6.5	150	100	10
14	19	7	150	105	10

115G.200 (mm)	D (mm)	(mm)	L (mm)	(g)	(pcs.)
7	11.5	3.5	200	86	10
8	12.7	4	200	89	10
10	14.5	4.5	200	96	10
12	17	6	200	119	10
13	18	6.5	200	125	10
14	19	7	200	128	10

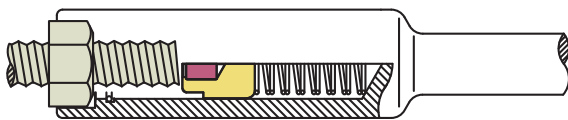

Sliding magnet system provides bolt clearance and magnetic function at the same time. The item 115G is mainly designed for assembly line work.

El sistema de imán corredizo proporciona espacio para el perno y al mismo tiempo acción magnética. El artículo 115G está diseñado específicamente para líneas de montaje.

### 119

Nut Setters with Magnet  
Vasos para tuercas con Imán

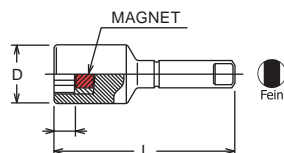

119.50 (mm)	D (mm)	(mm)	L (mm)	(g)	(pcs.)
5.5	9	2.1	50	17	10
6	10	2.4	50	20	10
7	11	2.8	50	22	10
8	12	3.5	50	23	10
10	14	4.2	50	30	10
12	17	5.6	50	42	10
13	18	6	50	52	10

119.50 (inch)	D (mm)	(mm)	L (mm)	(g)	(pcs.)
1/4	10	1.8	50	20	10
5/16	12	3.5	50	23	10
3/8	14	4.2	50	30	10

# Screwdrivers





# Screwdrivers

HAND MANUALES  
Z-SERIES  
TITANIUM DE TITANIO  
ACCESSORIES ACCESORIOS  
SCREWDRIVERS DESTORNILLADORES  
IMPACT DE IMPACTO  
SLEEVE-DRIVE  
INDUSTRIAL INDUSTRIALES  
AUTOMOTIVE  
CONSTRUCTION CONSTRUCCION  
RENEWAL KITS JUEGOS DE PIEZAS REPLÉSTO

## 167M • 167A Socket Drivers Destornilladores de Vaso

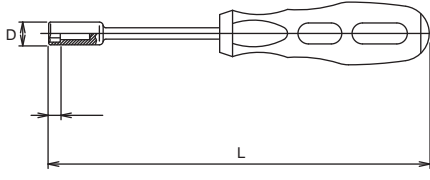

167M (mm)	D (mm)	(mm)	L (mm)	(g)	(pcs.)
3	5.8	3	225	62	6
3.5	5.8	3	225	62	6
4	6.7	3.5	225	64	6
4.5	7.2	4.5	225	65	6
5	7.8	5	225	66	6
5.5	8.4	5.5	225	68	6
6	9.1	6	225	70	6
7	10.9	6.5	235	101	6
8	12	7	235	103	6
9	13.2	7.5	235	107	6
10	14.5	8	235	111	6
11	15.9	8.5	245	155	6
12	16.8	9	245	161	6
13	18.2	9.5	245	167	6
14	19.2	11	245	178	6

167A (inch)	D (mm)	(mm)	L (mm)	(g)	(pcs.)
1/4	9.1	6	225	70	6

## 167C (2B) Interchangeable Socket Driver, Nut Grip®

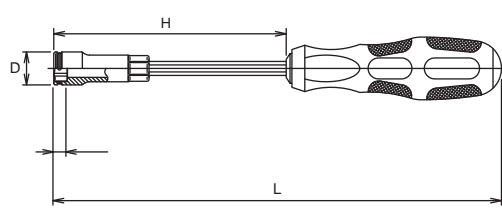

167C(2B) (mm)	D (mm)	H (mm)	(mm)	L (mm)	(g)	(pcs.)
7(2B)	11.5	122	4	235	120	6
8(2B)	12.3	122	5	235	125	6
10(2B)	14.2	122	6	235	130	6
12(2B)	17.3	122	7	235	135	6

  

167C/3-2B	4 Pieces Set/280g
PLASTIC BAG	
Socket Drivers	
Socket:	7, 8, 10
Grip:	167C-GRIP

**168H-B**  Ball point Hex Screwdrivers 



168H (mm)	(mm)	L (mm)	(g)	(pcs.)
<b>3B</b>	80	150	25	6
<b>4B</b>	125	225	60	6
<b>5B</b>	125	235	85	6
<b>6B</b>	125	245	150	6
<b>7B</b>	125	245	151	6
<b>8B</b>	125	245	153	6

 Ball point Hex Screwdrivers have less strength due to the special design. Make sure to use them correctly.

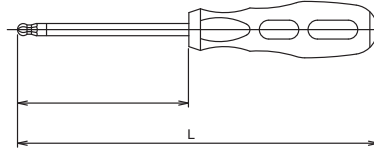

**168T (TH)**  Tamper-Resistant TORX® Screwdrivers 



168T (TH)	(mm)	L (mm)	(g)	(pcs.)
<b>T10H</b>	80	150	25	6
<b>T15H</b>	80	150	25	6
<b>T20H</b>	125	225	60	6
<b>T25H</b>	125	225	60	6
<b>T27H</b>	125	235	90	6
<b>T30H</b>	125	235	92	6
<b>T40H</b>	125	245	153	6

 Tamper Resistant TORX® Screwdrivers have less strength due to the special design. Make sure to use it correctly.

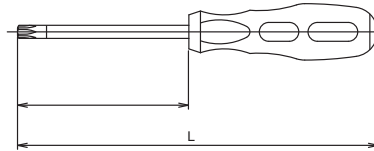

**168T/7 (TH)**  Set Juego 

168T/7-TH	(g)
<b>168T-T10H, T15H, T20H, T25H, T27H, T30H, T40H</b>	480



**168R**  Square Screwdrivers



168R	(mm)	L (mm)	(g)	(pcs.)
<b>1</b>	125	225	60	6
<b>2</b>	125	235	85	6

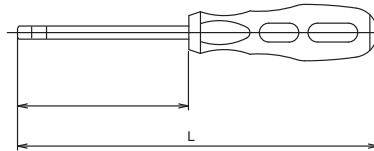

**168P (PZ)**  PZ Screwdrivers



168P (PZ)	(mm)	L (mm)	(g)	(pcs.)
<b>PZ1</b>	75	175	78	6
<b>PZ2</b>	100	210	129	6
<b>PZ3</b>	150	270	203	6

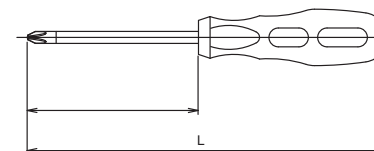

**TORX** is a registered trademark of Acument Intellectual Properties, LLC.  
**TORX** es una marca registrada de Acument Intellectual Properties, LLC.

# Screwdrivers

HAND MANUALES  
Z-SERIES  
TITANIUM DE TITANIO  
ACCESSORIES ACCESORIOS  
SCREWDRIVERS DESTORNILLADORES  
IMPACT DE IMPACTO  
SLEEVE-DRIVE  
INDUSTRIAL INDUSTRIALES  
AUTOMOTIVE  
CONSTRUCTION CONSTRUCCION  
RENEWAL KITS JUEGOS DE PIEZAS REPLISTO

**166P**  Screwdrivers (Blade-Through type)  
Destornilladores  
**166S** 

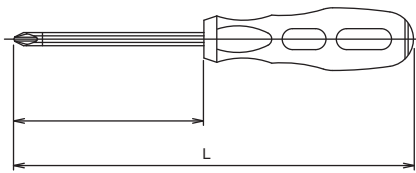



166P (PH)	(mm)	L (mm)	(g)	(pcs.)
1	75	175	78	6
2	100	210	129	6
3	150	270	203	6

166S	(mm)	L (mm)	(g)	(pcs.)
5	75	175	78	6
6	100	210	129	6
8	150	270	203	6



**166PS/6**   Set Juego



166PS/6	6 Pieces Set/△=885g
CARDBOARD BOX:W280xH115xT40mm	
Screwdrivers	
	166P Screwdrivers 1, 2, 3
	166S Screwdrivers 5, 6, 8

**PK166PS/6**   Set Juego



PK166PS/6	6 Pieces Set/△=950g
PLASTIC TRAY	
Screwdrivers	
	166P Screwdrivers 1, 2, 3
	166S Screwdrivers 5, 6, 8

HAND  
MANUALES

Z-SERIES

TITANIUM  
DE TITANIO

ACCESSORIES  
ACCESORIOS

SCREWDRIVERS  
DESTORNILLADORES

IMPACT  
DE IMPACTO

SLEEVE-DRIVE

INDUSTRIAL  
INDUSTRIALES

AUTOMOTIVE

CONSTRUCTION  
CONSTRUCCION

RENEWAL KITS  
JUEGOS DE PIEZAS REPUESTO

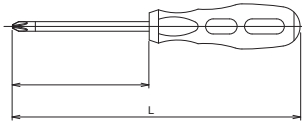

**168P**  Screwdrivers  
Destornilladores

**168S** 





168P (PH)	(mm)	L (mm)	(g)	(pcs.)
1	75	175	59	6
2	100	210	86	6
<b>New</b> 2(150)	150	260	100	6
<b>New</b> 2(200)	200	310	111	6
3	150	270	150	6

168S	(mm)	L (mm)	(g)	(pcs.)
5	75	175	59	6
6	100	210	86	6
<b>New</b> 6(150)	150	260	100	6
<b>New</b> 6(200)	200	310	111	6
8	150	270	150	6

**168PS/6** 6 Pieces Set   =660g  
 CARDBOARD BOX:W280xH115xT40mm  
 Screwdrivers

 **168P** Screwdrivers  
1, 2, 3

 **168S** Screwdrivers  
5, 6, 8

**PK168PS/6** 6 Pieces Set   =720g  
 PLASTIC TRAY  
 Screwdrivers

 **168P** Screwdrivers  
1, 2, 3

 **168S** Screwdrivers  
5, 6, 8

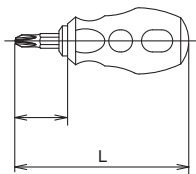

168CS	(mm)	L (mm)	(g)	(pcs.)
2x6	22	86	46	6

**168PS/6**   Set  
Juego



**PK168PS/6**   Set  
Juego



**168CS**   Interchangeable Screwdrivers, Stubby



**168C**   Interchangeable Screwdrivers

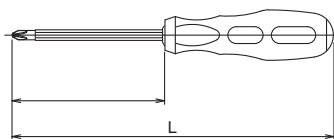

168C	(mm)	L (mm)	(g)	(pcs.)
2x6	100	210	108	6
2x6(150)	150	260	120	6
2x6(200)	200	310	133	6

# Screwdrivers

HAND MANUALES  
Z-SERIES  
TITANIUM DE TITANIO  
ACCESSORIES ACCESORIOS  
SCREWDRIVERS DESTORNILLADORES  
IMPACT DE IMPACTO  
SLEEVE-DRIVE  
INDUSTRIAL INDUSTRIALES  
AUTOMOTIVE  
CONSTRUCTION CONSTRUCCION  
RENEWAL KITS JUEGOS DE PIEZAS REPLUSTO

## 2769N-150 • -220 Spin Type Handle Mango Tipo Destornillador ⚠



2769N		(mm)	L (mm)	(g)	(pcs.)
150	1/4"	50	150	68	2
220		120	220	100	2

⚠ Plastic or rubber handles are not intended to act as insulation.  
Los mangos de plástico o de goma no están previstos para aislamiento.

## 2769NWF-150 • -220 Spin Type Handle (Wobble-Fix) Mango Tipo Destornillador (Articulado-Fijo) ⚠



2769NWF		(mm)	L (mm)	(g)	(pcs.)
150	1/4"	50	150	68	2
220		120	220	100	2

### Wobble-Fix Extension Bar

Two way usage : One for as a flexible extension bar to provide at 15° angle operation, the other for use as a normal extension bar. This usage is Patent.

### Alargadera Articulada-Fija

Dos formas de utilización : Una como alargadera flexible para poder trabajar con un ángulo de 15° y otra para utilizarse como alargadera normal. Esta aplicación está patentada.

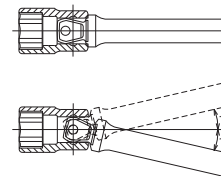

## 3769N-160 • -230 Spin Type Handle Mango Tipo Destornillador ⚠



3769N		(mm)	L (mm)	(g)	(pcs.)
160	3/8"	50	160	96	2
230		120	230	126	2

## 3769NWF-160 • -230 Spin Type Handle (Wobble-Fix) Mangos Tipo Destornillador (Articulado-Fijo) ⚠



3769NWF		(mm)	L (mm)	(g)	(pcs.)
160	3/8"	50	160	96	2
230		120	230	126	2



# Impact Sockets

1/4"

3/8"

1/2"

5/8"

3/4"

1"

1-1/2"

2-1/2"

3-1/2"



HAND MANUALES  
Z-SERIES  
TITANIUM DE TITANIO  
ACCESSORIES ACCESORIOS  
SCREWDRIVERS DESTORNILLADORES  
IMPACT DE IMPACTO  
SLEEVE-DRIVE  
INDUSTRIAL INDUSTRIALES  
AUTOMOTIVE  
CONSTRUCTION CONSTRUCCIÓN  
RENEWAL KITS JUEGOS DE PIEZAS REPLUSTO

### 12400M • 12400A

6-point Sockets  
Vasos Hexagonales

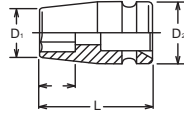

## FLAT DRIVE®

Flat drive is designed to guarantee a flat surface contact between the socket and the bolt/nut. The Flat contact reduces wear and allows to transmit a higher torque value. The Flat Drive System is also used for the square drive end as well as the hexagonal or bi-hexagonal openings of the socket.

El diseño de contacto plano garantiza una superficie de contacto plana entre el vaso y el perno/tuerca. El contacto plano reduce el desgaste y permite transmitir más par. El Sistema de Contacto Plano se utiliza tanto para el extremo del cuadrado conductor como para la boca del vaso Hex o Bihex.

12400M (mm)	D <sub>1</sub> (mm)	D <sub>2</sub> (mm)	(mm)	L (mm)	(g)	(pcs.)	
4	7.5	13	4	23	14	10	*1
4.5	8.1	13	4	23	14	10	*1
5	8.8	13	4	23	14	10	*1
5.5	9.4	13	4	23	14	10	*1
6	10	13	5	23	14	10	*1
7	11.3	13	5	23	14	10	*1
8	12.5	13	6	23	14	10	*1
9	13.8	13	7	23	14	10	*1
10	15	13	7	23	15	10	*1
11	16.3	13	8	23	18	10	*1
12	17.5	13	8	23	19	10	*1
13	18.8	13	8	23	19	10	*1
14	20	13	9	23	20	10	*1

12400A (inch)	D <sub>1</sub> (mm)	D <sub>2</sub> (mm)	(mm)	L (mm)	(g)	(pcs.)	
5/32	7.5	13	4	23	14	10	*1
3/16	8.1	13	4	23	14	10	*1
1/4	10	13	5	23	14	10	*1
9/32	11.3	13	5	23	14	10	*1
5/16	12.5	13	6	23	14	10	*1
11/32	13.8	13	7	23	14	10	*1
3/8	15	13	7	23	15	10	*1
7/16	16.3	13	8	23	18	10	*1
1/2	18.8	13	8	23	19	10	*1
9/16	20	13	9	23	20	10	*1

\*1 Pin/O-Ring=1200A/B → P233

### 12400MG • 12400AG

6-point Sockets with Magnet  
Vasos Hexagonales con Imán

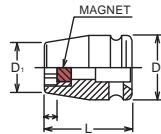

12400MG (mm)	D <sub>1</sub> (mm)	D <sub>2</sub> (mm)	(mm)	L (mm)	(g)	(pcs.)	
4	7.5	13	2.1	23	12	10	*1
4.5	8.1	13	2.1	23	13	10	*1
5	8.8	13	2.1	23	15	10	*1
5.5	9.4	13	2.1	23	15	10	*1
6	10	13	2.4	23	16	10	*1
7	11.3	13	2.8	23	16	10	*1
8	12.5	13	3.5	23	17	10	*1
9	13.8	13	3.8	23	18	10	*1
10	15	13	4.2	23	18	10	*1
11	16.3	13	4.9	23	21	10	*1
12	17.5	13	5.6	25	21	10	*1
13	18.8	13	6	25	21	10	*1
14	20	13	6.4	25	20	10	*1

12400AG (inch)	D <sub>1</sub> (mm)	D <sub>2</sub> (mm)	(mm)	L (mm)	(g)	(pcs.)	
3/16	8.1	13	2.1	23	13	10	*1
1/4	10	13	2.4	23	16	10	*1
5/16	12.5	13	3.5	23	17	10	*1
11/32	13.8	13	3.8	23	18	10	*1
3/8	15	13	4.2	23	18	10	*1
7/16	16.3	13	4.9	23	21	10	*1
1/2	18.8	13	6	25	21	10	*1
9/16	20	13	6.4	25	20	10	*1

\*1 Pin/O-Ring=1200A/B → P233

### 12410M

Surface Drive Sockets  
Vasos Surface Drive (de Contacto Curvo)

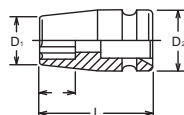

## SURFACE DRIVE

Surface drive sockets are designed to retain contact with flat sides of nut to transmit high torque and reduce nut wear. These sockets are ideal for use on polished nuts, aluminum nuts and nuts with worn out points.

Los vasos de contacto curvo se diseñan para mantener el contacto con las caras planas de la tuerca y transmitir un alto par reduciendo el desgaste de la tuerca. Estos vasos son ideales para utilizarse en tuercas pulidas, tuercas de aluminio y tuercas con puntas gastadas.

12410M (mm)	D <sub>1</sub> (mm)	D <sub>2</sub> (mm)	(mm)	L (mm)	(g)	(pcs.)	
6	10	13	5	23	14	10	*1
7	11.3	13	5	23	15	10	*1
8	12.5	13	6	23	15	10	*1
9	13.8	13	7	23	14	10	*1
10	15	13	7	23	14	10	*1
11	16.3	13	8	23	17	10	*1
12	17.5	13	8	23	19	10	*1
13	18.8	13	8	23	19	10	*1

\*1 Pin/O-Ring=1200A/B → P233

# 1/4" Impact Sockets

12465M (mm)	D <sub>1</sub> (mm)	D <sub>2</sub> (mm)	(mm)	L (mm)	(g)	(pcs.)	
10	15	13	8	23	17	10	*1
11	16.3	13	8	23	18	10	*1
12	17.5	13	9	23	18	10	*1
13	18.8	13	9	23	20	10	*1

\*1 Pin/O-Ring=1200A/B → P233

## 12465M Pathfinder Sockets Vasos Pathfinder (Guía)

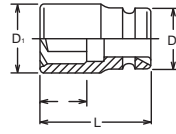

12425 (E)	D <sub>1</sub> (mm)	D <sub>2</sub> (mm)	(mm)	L (mm)	(g)	(pcs.)	
E 4	6.6	13	4.6	23	14	10	*1
E 5	7.7	13	5.2	23	15	10	*1
E 6	8.7	13	5.4	23	15	10	*1
E 7	9.2	13	6.6	23	15	10	*1
E 8	9.7	13	7	23	15	10	*1
E10	12.2	13	8.2	23	15	10	*1

\*1 Pin/O-Ring=1200A/B → P233

## 12425 TORX® Sockets Vasos TORX®

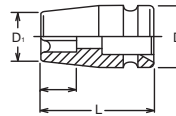

### TORX® (E)

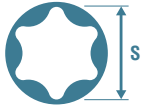

E		E4	E5	E6	E7	E8	E10	E11	E12	E14	E16	E18	E20	E22	E24	E26	E28
S	(ref. mm)	3.83	4.72	5.69	6.17	7.47	9.37	10.03	11.12	12.85	14.71	16.64	18.41	20.24	22.10	23.85	25.65

12460M (mm)	D <sub>1</sub> (mm)	D <sub>2</sub> (mm)	(mm)	L (mm)	(g)	(pcs.)	
5.5	9.7	13	4	23	15	10	*1
6	10.3	13	5	23	15	10	*1
7	11.6	13	5	23	16	10	*1
8	12.8	13	6	23	16	10	*1
10	15.3	13	7	23	19	10	*1
13	19.1	13	8	23	23	10	*1

12460A (inch)	D <sub>1</sub> (mm)	D <sub>2</sub> (mm)	(mm)	L (mm)	(g)	(pcs.)	
1/4	10.3	13	5	23	15	10	*1
5/16	12.8	13	6	23	16	10	*1
3/8	15.3	13	7	23	19	10	*1
1/2	19.1	13	8	23	23	10	*1

\*1 Pin/O-Ring=1200A/B → P233

## 12460M • 12460A For Self-Tapping Screws Para Tornillos Autorroscantes

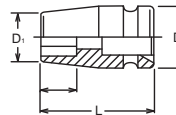

12460MG (mm)	D <sub>1</sub> (mm)	D <sub>2</sub> (mm)	(mm)	L (mm)	(g)	(pcs.)	
5.5	9.7	13	2.1	23	16	10	*1
6	10.3	13	2.4	23	16	10	*1
7	11.6	13	2.8	23	16	10	*1
8	12.8	13	3.5	25	18	10	*1
10	15.3	13	4.2	28	20	10	*1
13	19.1	13	6	30	23	10	*1
14	20	13	6.4	30	24	10	*1

12460AG (inch)	D <sub>1</sub> (mm)	D <sub>2</sub> (mm)	(mm)	L (mm)	(g)	(pcs.)	
1/4	10.3	13	2.4	23	16	10	*1
5/16	12.8	13	3.5	25	18	10	*1
3/8	15.3	13	4.2	28	20	10	*1
7/16	16.6	13	4.9	29	27	10	*1
1/2	19.1	13	6	30	23	10	*1

\*1 Pin/O-Ring=1200A/B → P233

## 12460MG • 12460AG With Magnet for Self-Tapping Screws Con Imán para Tornillos Autorroscantes

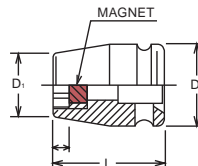

HAND MANUALES  
Z-SERIES  
TITANIUM DE TITANIO  
ACCESSORIES ACCESORIOS  
SCREWDRIVERS DESTORNILLADORES  
IMPACT DE IMPACTO  
SLEEVE-DRIVE INDUSTRIAL INDUSTRIALES  
AUTOMOTIVE  
CONSTRUCTION CONSTRUCCION  
RENEWAL KITS JUEGOS DE PIEZAS REPUESTO

# Impact Sockets 1/4"

HAND MANUALES  
Z-SERIES  
TITANIUM DE TITANIO  
ACCESSORIES ACCESORIOS  
SCREWDRIVERS DESTORNILLADORES  
IMPACT DE IMPACTO  
SLEEVE-DRIVE  
INDUSTRIAL INDUSTRIALES  
AUTOMOTIVE  
CONSTRUCTION CONSTRUCCION  
RENEWAL KITS JUEGOS DE PIEZAS REPLUSTO

## 12300M 6-point Sockets, deep Vasos Hexagonales Largos



12300M (mm)	D <sub>1</sub> (mm)	D <sub>2</sub> (mm)	(mm)	L (mm)	(g)	(pcs.)	
New 7	11.3	13	7	48	30	10	*1
8	12.5	13	8	48	32	10	*1
10	15	13	10	48	34	10	*1
New 11	16.3	13	11	48	46	10	*1
12	17.5	13	12	48	49	10	*1
13	18.8	13	13	48	52	10	*1
14	20	13	14	48	57	10	*1

\*1 Pin/O-Ring=1200A/B → P233

## 12365M Pathfinder Sockets, deep Vasos Pathfinder (Guía) Largos



12365M (mm)	D <sub>1</sub> (mm)	D <sub>2</sub> (mm)	(mm)	L (mm)	(g)	(pcs.)	
10	15	13	8	48	34	10	*1
11	16.3	13	8	48	46	10	*1
12	17.5	13	9	48	49	10	*1
13	18.8	13	9	48	52	10	*1

\*1 Pin/O-Ring=1200A/B → P233

## 12300G Impact Socket with Sliding Magnet Vasos de Impacto con Imán Corredizo



12300G (mm)	D <sub>1</sub> (mm)	D <sub>2</sub> (mm)	(mm)	L (mm)	(g)	(pcs.)	
8	12.5	13	4	48	32	10	*1
10	15	13	4.5	48	34	10	*1
12	17.5	13	6	48	49	10	*1
13	18.8	13	6.5	48	52	10	*1
14	20	13	7	48	57	10	*1

\*1 Pin/O-Ring=1200A/B → P233

## 12760-55 · -75 Extension Bars Alargaderas

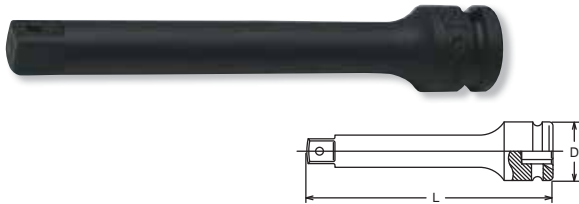

12760	D (mm)	L (mm)	(g)	(pcs.)	
55	13	55	26	10	*1
75	13	75	45	10	*1

\*1 Pin/O-Ring=1200A/B → P233

### Lock & Quick Release

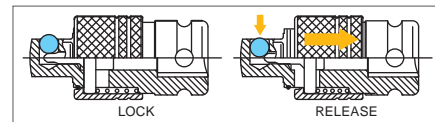

	L (mm)	(g)	(pcs.)	
12222AL	35	30	10	*1

\*1 Pin/O-Ring=1200A/B → P233

## 12222AL Adaptor (Quick Release) Adaptador (Extracción Rápida)

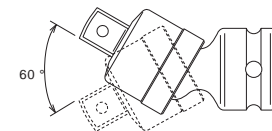

## 12770 Universal Joint Articulación Universal



	L (mm)	(g)	(pcs.)	
12770	39	30	10	*1

\*1 Pin/O-Ring=1200A/B → P233

## 12233A Adaptor Adaptador



	(sq.)	(sq.)	L (mm)	(g)	(pcs.)	
12233A	1/4"	3/8"	22	15	10	*1
12233A-B	1/4"	3/8"	22	15	10	*1
12233A-P	1/4"	3/8"	22	15	10	*1

\*1 Pin/O-Ring=1200A/B → P233

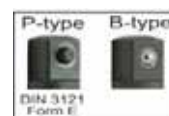

13400M (mm)	D <sub>1</sub> (mm)	D <sub>2</sub> (mm)	(mm)	L (mm)	(g)	(pcs.)	
6	10.8	19	5	32	40	10	*1
7	12	19	5	32	40	10	*1
8	13.3	19	6	32	40	10	*1
9	14.5	19	7	32	40	10	*1
10	15.8	19	7	32	40	10	*1
11	17	19	8	32	41	10	*1
12	18.3	19	9	32	43	10	*1
13	19.5	22	10	32	56	10	*2
14	20.8	22	10	32	56	10	*2
15	22	22	11	32	56	10	*2
16	23.3	22	11	32	57	10	*2
17	24.5	22	12	32	60	10	*2
18	25.8	22	12	32	62	10	*2
19	27	22	12	32	67	10	*2
20	28.3	22	12	32	70	10	*2
21	29.5	22	12	32	71	10	*2
22	30.8	22	13	32	72	10	*2
23	32	22	13	32	75	10	*2
24	33.3	22	13	32	78	10	*2

## 13400M • 13400A 6-point Sockets Vasos Hexagonales

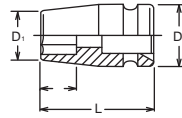

13400A (inch)	D <sub>1</sub> (mm)	D <sub>2</sub> (mm)	(mm)	L (mm)	(g)	(pcs.)	
1/4	10.8	19	5	32	40	10	*1
5/16	13.3	19	6	32	40	10	*1
3/8	15.8	19	7	32	40	10	*1
7/16	17	19	8	32	41	10	*1
1/2	19.5	22	10	32	56	10	*2
9/16	20.8	22	10	32	56	10	*2
5/8	23.3	22	11	32	57	10	*2
11/16	24.5	22	12	32	60	10	*2
3/4	27	22	12	32	67	10	*2
13/16	29.5	22	12	32	71	10	*2
7/8	30.8	22	13	32	72	10	*2

\*1 C-Ring=1301C, Pin/O-Ring=1301A/B → P232-233  
\*2 C-Ring=1302C, Pin/O-Ring=1302A/B

13405M (mm)	D <sub>1</sub> (mm)	D <sub>2</sub> (mm)	(mm)	L (mm)	(g)	(pcs.)	
8	13.3	19	6	32	40	10	*1
9	14.5	19	7	32	40	10	*1
10	15.8	19	7	32	40	10	*1
12	18.3	19	9	32	43	10	*1
13	19.5	22	10	32	56	10	*2
14	20.8	22	10	32	56	10	*2
15	22	22	11	32	56	10	*2
17	24.5	22	12	32	60	10	*2
19	27	22	12	32	67	10	*2

## 13405M • 13405A 12-point Sockets Vasos Bihexagonales

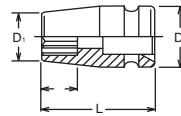

13405A (inch)	D <sub>1</sub> (mm)	D <sub>2</sub> (mm)	(mm)	L (mm)	(g)	(pcs.)	
1/4	10.8	19	5	32	40	10	*1
5/16	13.3	19	6	32	40	10	*1
3/8	15.8	19	7	32	40	10	*1
7/16	17	19	8	32	41	10	*1
1/2	19.5	22	10	32	56	10	*2
9/16	20.8	22	10	32	56	10	*2
5/8	23.3	22	11	32	57	10	*2
11/16	24.5	22	12	32	60	10	*2
3/4	27	22	12	32	67	10	*2
13/16	29.5	22	12	32	71	10	*2
7/8	30.8	22	13	32	72	10	*2

\*1 C-Ring=1301C, Pin/O-Ring=1301A/B → P232-233  
\*2 C-Ring=1302C, Pin/O-Ring=1302A/B

13401MS (mm)	D <sub>1</sub> (mm)	D <sub>2</sub> (mm)	(mm)	L (mm)	(g)	(pcs.)	
8	12.3	18.5	6	22	25	10	*1
10	14.8	18.5	6	22	25	10	*1
12	17.3	18.5	10	22	20	10	*1
13	18.5	21.5	10	22	30	10	*2
14	19.8	21.5	10	22	30	10	*2

\*1 C-Ring=1301C, Pin/O-Ring=1301A/B → P232-233  
\*2 C-Ring=1302C, Pin/O-Ring=1302A/B

## 13401MS 6-point short sockets, Thin-walled. Vasos Hexagonales de Pared Delgada, Short

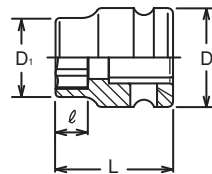

RS13401MS/5	5 Pieces Set/Rail 150mm	(g)
	8, 10, 12, 13, 14	180

## RS13401MS/5 Socket Set on Rail Juego de Vasos en Regleta



HAND MANUALES  
Z-SERIES  
TITANIUM DE TITANIO  
ACCESSORIES ACCESORIOS  
SCREWDRIVERS DESTORNILLADORES  
IMPACT DE IMPACTO  
SLEEVE-DRIVE  
INDUSTRIAL INDUSTRIALES  
AUTOMOTIVE  
CONSTRUCTION CONSTRUCCION  
RENEWAL KITS JUEGOS DE PIEZAS REPUESTO



# Impact Sockets **3/8"**

HAND MANUALES  
Z-SERIES  
TITANIUM DE TITANIO  
ACCESSORIES ACCESORIOS  
SCREWDRIVERS DESTORNILLADORES  
IMPACT DE IMPACTO  
SLEEVE-DRIVE  
INDUSTRIAL INDUSTRIALES  
AUTOMOTIVE  
CONSTRUCTION CONSTRUCCION  
RENEWAL KITS JUEGOS DE PIEZAS/REPLISTO

## 13401M • 13401A

6-point Socket, Thin Walled  
Vasos Hexagonales de Pared Delgada

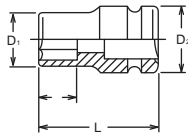

13401A (inch)	D <sub>1</sub> (mm)	D <sub>2</sub> (mm)	(mm)	L (mm)	(g)	(pcs.)	
1/4	9.8	18.5	5	32	28	10	*1
5/16	12.3	18.5	6	32	31	10	*1
3/8	14.8	18.5	7	32	34	10	*1
7/16	16	18.5	8	32	35	10	*1
1/2	18.5	21.5	10	32	43	10	*2
9/16	19.8	21.5	10	32	49	10	*2
5/8	22.3	21.5	11	32	51	10	*2
11/16	23.5	21.5	12	32	54	10	*2
3/4	26	21.5	12	32	60	10	*2
13/16	28.5	21.5	12	32	70	10	*2
7/8	29.8	21.5	13	32	73	10	*2

\*1 C-Ring=1301C, Pin/O-Ring=1301A/B  
\*2 C-Ring=1302C, Pin/O-Ring=1302A/B → P232-233

13401M (mm)	D <sub>1</sub> (mm)	D <sub>2</sub> (mm)	(mm)	L (mm)	(g)	(pcs.)	
6	9.8	18.5	5	32	28	10	*1
7	11	18.5	5	32	30	10	*1
8	12.3	18.5	6	32	31	10	*1
9	13.5	18.5	7	32	32	10	*1
10	14.8	18.5	7	32	34	10	*1
11	16	18.5	8	32	35	10	*1
12	17.3	18.5	9	32	36	10	*1
13	18.5	21.5	10	32	43	10	*2
14	19.8	21.5	10	32	49	10	*2
15	21	21.5	11	32	49	10	*2
16	22.3	21.5	11	32	51	10	*2
17	23.5	21.5	12	32	54	10	*2
18	24.8	21.5	12	32	57	10	*2
19	26	21.5	12	32	60	10	*2
20	27.3	21.5	12	32	65	10	*2
21	28.5	21.5	12	32	70	10	*2
22	29.8	21.5	13	32	73	10	*2
23	31	21.5	13	32	73	10	*2
24	32.3	21.5	13	32	75	10	*2

\*1 C-Ring=1301C, Pin/O-Ring=1301A/B  
\*2 C-Ring=1302C, Pin/O-Ring=1302A/B → P232-233

## 13406M • 13406A

12-point Socket, Thin Walled  
Vasos Bihexagonales de Pared Delgada

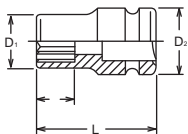

13406A (inch)	D <sub>1</sub> (mm)	D <sub>2</sub> (mm)	(mm)	L (mm)	(g)	(pcs.)	
1/4	9.8	18.5	5	32	28	10	*1
5/16	12.3	18.5	6	32	31	10	*1
3/8	14.8	18.5	7	32	34	10	*1
7/16	16	18.5	8	32	35	10	*1
1/2	18.5	21.5	10	32	43	10	*2
9/16	19.8	21.5	10	32	49	10	*2
5/8	22.3	21.5	11	32	51	10	*2
11/16	23.5	21.5	12	32	54	10	*2
3/4	26	21.5	12	32	60	10	*2
13/16	28.5	21.5	12	32	70	10	*2
7/8	29.8	21.5	13	32	73	10	*2

\*1 C-Ring=1301C, Pin/O-Ring=1301A/B  
\*2 C-Ring=1302C, Pin/O-Ring=1302A/B → P232-233

13406M (mm)	D <sub>1</sub> (mm)	D <sub>2</sub> (mm)	(mm)	L (mm)	(g)	(pcs.)	
6	9.8	18.5	5	32	28	10	*1
7	11	18.5	5	32	30	10	*1
8	12.3	18.5	6	32	31	10	*1
9	13.5	18.5	7	32	32	10	*1
10	14.8	18.5	7	32	34	10	*1
11	16	18.5	8	32	35	10	*1
12	17.3	18.5	9	32	36	10	*1
13	18.5	21.5	10	32	43	10	*2
14	19.8	21.5	10	32	49	10	*2
15	21	21.5	11	32	49	10	*2
16	22.3	21.5	11	32	51	10	*2
17	23.5	21.5	12	32	54	10	*2
18	24.8	21.5	12	32	57	10	*2
19	26	21.5	12	32	60	10	*2
20	27.3	21.5	12	32	65	10	*2
21	28.5	21.5	12	32	70	10	*2
22	29.8	21.5	13	32	73	10	*2
23	31	21.5	13	32	73	10	*2
24	32.3	21.5	13	32	75	10	*2

\*1 C-Ring=1301C, Pin/O-Ring=1301A/B  
\*2 C-Ring=1302C, Pin/O-Ring=1302A/B → P232-233

## RS13401M/9

Socket Set on Rail  
Juego de Vasos en Regleta



RS13401M/9	9 Pieces Set/Rail 250mm	(g)
8, 10, 12, 13, 14, 17, 19, 21, 22		505

13400MG (mm)	D <sub>1</sub> (mm)	D <sub>2</sub> (mm)	(mm)	L (mm)	(g)	(pcs.)	
6	10.8	19	2.4	32	46	10	*1
7	12	19	2.8	32	45	10	*1
8	13.3	19	3.5	32	45	10	*1
9	14.5	19	3.8	32	44	10	*1
10	15.8	19	4.2	32	49	10	*1
11	17	19	4.9	32	50	10	*1
12	18.3	19	5.6	32	55	10	*1
13	19.5	22	6	32	70	10	*2
14	20.8	22	6.4	32	76	10	*2
15	22	22	6.8	32	76	10	*2
16	23.3	22	7	32	88	10	*2
17	24.5	22	7.5	32	95	10	*2
18	25.8	22	7.8	32	105	10	*2
19	27	22	8	32	116	10	*2
21	29.5	22	8	32	125	10	*2
22	30.8	22	9.5	32	135	10	*2

\*1 C-Ring=1301C, Pin/O-Ring=1301A/B  
 \*2 C-Ring=1302C, Pin/O-Ring=1302A/B → P232-233

13410M (mm)	D <sub>1</sub> (mm)	D <sub>2</sub> (mm)	(mm)	L (mm)	(g)	(pcs.)	
6	10.8	19	5	32	40	10	*1
7	12	19	5	32	40	10	*1
8	13.3	19	6	32	40	10	*1
9	14.5	19	7	32	40	10	*1
10	15.8	19	7	32	40	10	*1
11	17	19	8	32	42	10	*1
12	18.3	19	9	32	50	10	*1
13	19.5	22	10	32	56	10	*2
14	20.8	22	10	32	56	10	*2
15	22	22	11	32	56	10	*2
16	23.3	22	11	32	57	10	*2
17	24.5	22	12	32	60	10	*2
19	27	22	12	32	67	10	*2
22	30.8	22	13	32	72	10	*2

\*1 C-Ring=1301C, Pin/O-Ring=1301A/B  
 \*2 C-Ring=1302C, Pin/O-Ring=1302A/B → P232-233

13465M (mm)	D <sub>1</sub> (mm)	D <sub>2</sub> (mm)	(mm)	L (mm)	(g)	(pcs.)	
8	13.3	19	8	32	40	10	*1
10	15.8	19	8	32	43	10	*1
11	17	19	8	32	44	10	*1
12	18.3	19	9	32	47	10	*1
13	19.5	22	9	32	55	10	*2
14	20.8	22	11	32	56	10	*2
15	22	22	11	32	56	10	*2
16	23.3	22	11	32	57	10	*2
17	24.5	22	12	32	60	10	*2
18	25.8	22	13	32	63	10	*2
19	27	22	13	32	66	10	*2

\*1 C-Ring=1301C, Pin/O-Ring=1301A/B  
 \*2 C-Ring=1302C, Pin/O-Ring=1302A/B → P232-233

13425 (E)	D <sub>1</sub> (mm)	D <sub>2</sub> (mm)	(mm)	L (mm)	(g)	(pcs.)	
E 4	9.7	19	4.6	32	44	10	*1
E 5	10.2	19	5.2	32	43	10	*1
E 6	10.7	19	5.4	32	44	10	*1
E 7	11.2	19	6.6	32	44	10	*1
E 8	11.7	19	7	32	44	10	*1
E10	12.2	19	8.2	32	42	10	*1
E12	14.2	19	9.3	32	43	10	*1
E14	17.2	19	10.6	32	44	10	*1
E16	18.2	19	11.8	32	42	10	*1

\*1 C-Ring=1301C, Pin/O-Ring=1301A/B → P232-233

13425-EPL (EPL)	D <sub>1</sub> (mm)	D <sub>2</sub> (mm)	(mm)	L (mm)	(g)	(pcs.)	
8EPL	12	19	5.2	32	44	10	*1
10EPL	13.3	19	6.2	32	44	10	*1

\*1 C-Ring=1301C, Pin/O-Ring=1301A/B → P232-233

## 13400MG • 13400AG

6-point Sockets with Magnet  
 Vasos Hexagonales con Imán

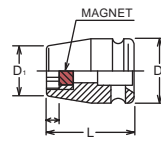

13400AG (inch)	D <sub>1</sub> (mm)	D <sub>2</sub> (mm)	(mm)	L (mm)	(g)	(pcs.)	
1/4	10.8	19	2.4	32	46	10	*1
5/16	13.3	19	3.5	32	45	10	*1
11/32	14.5	19	3.8	32	44	10	*1
3/8	15.8	19	4.2	32	49	10	*1
7/16	17	19	4.9	32	50	10	*1
1/2	19.5	22	6	32	70	10	*2
9/16	20.8	22	6.4	32	76	10	*2
5/8	23.3	22	7.5	32	88	10	*2
11/16	24.5	22	7.5	32	95	10	*2
3/4	27	22	8	32	116	10	*2

\*1 C-Ring=1301C, Pin/O-Ring=1301A/B  
 \*2 C-Ring=1302C, Pin/O-Ring=1302A/B → P232-233

## 13410M

Surface Drive Sockets  
 Vasos Surface Drive (de Contacto Curvo)

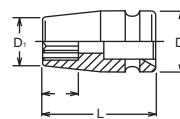

## 13465M

Pathfinder Sockets  
 Vasos Pathfinder (Guía)

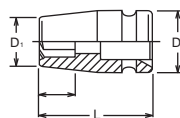

## 13425

TORX® Sockets  
 Vasos TORX®

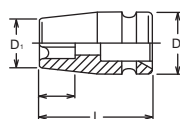

## 13425-EPL

TORX PLUS® Sockets  
 Vasos TORX PLUS®

**TORX** plus®

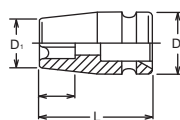

HAND MANUALES  
 Z-SERIES  
 TITANIUM DE TITANIO  
 ACCESORIES ACCESORIOS  
 SCREWDRIVERS DESTORNILLADORES  
 IMPACT DE IMPACTO  
 SLEEVE-DRIVE INDUSTRIAL INDUSTRIALES  
 AUTOMOTIVE  
 CONSTRUCTION CONSTRUCCION  
 RENEWAL KITS JUEGOS DE PIEZAS REPUESTO

# Impact Sockets **3/8"**

HAND MANUALES  
Z-SERIES  
TITANIUM DE TITANIO  
ACCESSORIES ACCESORIOS  
SCREWDRIVERS DESTORNILLADORES  
IMPACT DE IMPACTO  
SLEEVE-DRIVE  
INDUSTRIAL INDUSTRIALES  
AUTOMOTIVE  
CONSTRUCTION CONSTRUCCIÓN  
RENEWAL KITS JUEGOS DE PIEZAS REPLUSTO

## 13460M • 13460A

For Self-Tapping Screws  
Para Tornillos Autorroscantes

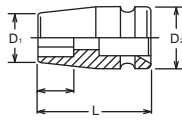

13460M (mm)	D <sub>1</sub> (mm)	D <sub>2</sub> (mm)	(mm)	L (mm)	(g)	(pcs.)	
6	11.4	19	5	32	43	10	*1
7	12.8	19	5	32	44	10	*1
8	14.1	19	6	32	44	10	*1
10	16.6	19	7	32	45	10	*1
13	20.3	22	10	32	60	10	*2

13460A (inch)	D <sub>1</sub> (mm)	D <sub>2</sub> (mm)	(mm)	L (mm)	(g)	(pcs.)	
1/4	11.4	19	5	32	43	10	*1
3/8	16.6	19	7	32	45	10	*1
1/2	20.3	22	10	32	60	10	*2

\*1 C-Ring=1301C, Pin/O-Ring=1301A/B → P232-233  
\*2 C-Ring=1302C, Pin/O-Ring=1302A/B

## 13460MG • 13460AG

Sockets with magnets for Self-Tapping Screws  
Vasos con Imán para Tornillos Autorroscantes

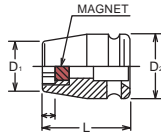

13460MG (mm)	D <sub>1</sub> (mm)	D <sub>2</sub> (mm)	(mm)	L (mm)	(g)	(pcs.)	
6	11.4	19	2.4	32	44	10	*1
7	12.8	19	2.8	32	46	10	*1
8	14.1	19	3.5	32	48	10	*1
10	16.6	19	4.2	33	54	10	*1
13	20.3	22	6	34	81	10	*2

13460AG (inch)	D <sub>1</sub> (mm)	D <sub>2</sub> (mm)	(mm)	L (mm)	(g)	(pcs.)	
1/4	11.4	19	2.4	32	44	10	*1
5/16	14.1	19	3.5	32	48	10	*1
3/8	16.6	19	4.2	33	54	10	*1
1/2	20.3	22	6	34	81	10	*2

\*1 C-Ring=1301C, Pin/O-Ring=1301A/B → P232-233  
\*2 C-Ring=1302C, Pin/O-Ring=1302A/B

## 13401LH

LHS Sockets  
Vasos LHS

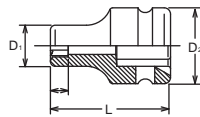

13401LH (LH-S)	D <sub>1</sub> (mm)	D <sub>2</sub> (mm)	(mm)	L (mm)	(g)	(pcs.)	
5S	11	19	5	32	32	10	*1
6S	12.3	19	5.6	32	34	10	*1
8S	16	19	6.8	32	36	10	*1
10S	18.5	22	8	32	50	10	*2
12S	22.3	22	9.2	32	58	10	*2
14S	24.8	22	10.4	32	63	10	*2
16S	28.5	22	11.6	32	77	10	*2

\*1 C-Ring=1301C, Pin/O-Ring=1301A/B → P232-233  
\*2 C-Ring=1302C, Pin/O-Ring=1302A/B

## LHSTIX® (LH-S)

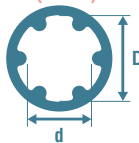

	LH-S	LH-5S	LH-6S	LH-8S	LH-10S	LH-12S	LH-14S	LH-16S
D	(ref. mm)	7.5	9.0	12.0	15.0	18.0	21.0	24.0
d	(ref. mm)	5.60	6.78	9.04	11.30	13.56	15.82	18.08

## 13400-WN

Weld Nut Sockets

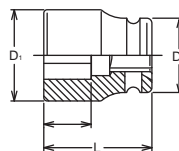

13400-WN	D <sub>1</sub> (mm)	D <sub>2</sub> (mm)	(mm)	L (mm)	(g)	(pcs.)	
6WN	15.8	19	6	32	48	10	*1
8WN	18.3	19	8	32	48	10	*1
9WN	19.5	22	9	32	47	10	*2
10WN	20.8	22	10	32	65	10	*2
12WN	24.5	22	12	32	73	10	*2
14WN	27	22	14	32	79	10	*2
17WN	32	22	17	35	110	10	*2

\*1 C-Ring=1301C, Pin/O-Ring=1301A/B → P232-233  
\*2 C-Ring=1302C, Pin/O-Ring=1302A/B

## WN



WN	6WN	8WN	9WN	10WN	12WN	14WN	17WN
S	(ref. mm)	6	8	9	10	12	14

# 3/8" Impact Sockets



13301X (mm)	D <sub>1</sub> (mm)	D <sub>2</sub> (mm)	(mm)	L (mm)	(g)	(pcs.)	
8	12.3	18.5	8	50	40	10	*1
10	14.8	18.5	10	50	46	10	*1
11	16	18.5	11	50	49	10	*1
12	17.3	18.5	12	50	53	10	*1
13	18.5	21.5	13	50	67	10	*2
14	19.8	21.5	14	50	70	10	*2
15	21	21.5	15	50	75	10	*2
16	22.3	21.5	16	50	78	10	*2
17	23.5	21.5	17	50	82	10	*2
<b>18</b>	24.8	21.5	18	50	86	10	*2
19	26	21.5	19	50	93	10	*2
21	28.5	21.5	21	50	104	10	*2
22	29.8	21.5	22	50	110	10	*2
23	31	21.5	23	50	115	10	*2
24	32.3	21.5	24	50	120	10	*2

\*1 C-Ring=1301C, Pin/O-Ring=1301A/B

\*2 C-Ring=1302C, Pin/O-Ring=1302A/B

→ P232-233

## 13301X 6-point Sockets, Semi-deep Vasos Hexagonales Medianos de Pared Delgada

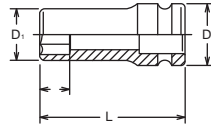

RS13301X/9	9 Pieces Set/Rail 250mm	(g)
8, 10, 12, 13, 14, 17, 19, 21, 22		710

## RS13301X/9 Socket Set on Rail Juego de Vasos en Regleta



13300XG (mm)	D <sub>1</sub> (mm)	D <sub>2</sub> (mm)	(mm)	L (mm)	(g)	(pcs.)	
8	13.3	19	4	50	40	10	*1
10	15.8	19	4.5	50	46	10	*1
12	18.3	19	6	50	55	10	*1
13	19.5	22	6.5	50	70	10	*2
14	20.8	22	7	50	75	10	*2

\*1 C-Ring=1301C, Pin/O-Ring=1301A/B

\*2 C-Ring=1302C, Pin/O-Ring=1302A/B

→ P232-233

## 13300XG Impact Sockets with Sliding Magnet Vasos de Impacto con Imán Corredizo

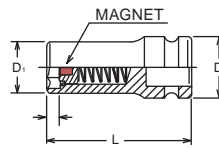

13300M (mm)	D <sub>1</sub> (mm)	D <sub>2</sub> (mm)	(mm)	L (mm)	(g)	(pcs.)	
6	10.8	19	6	80	77	10	*1
7	12	19	7	80	82	10	*1
8	13.3	19	8	80	82	10	*1
9	14.5	19	9	80	88	10	*1
10	15.8	19	10	80	94	10	*1
11	17	19	11	80	110	10	*1
12	18.3	19	12	80	111	10	*1
13	19.5	22	13	80	138	10	*2
14	20.8	22	14	80	148	10	*2
15	22	22	15	80	157	10	*2
16	23.3	22	16	80	156	10	*2
17	24.5	22	17	80	168	10	*2
18	25.8	22	18	80	190	10	*2
19	27	22	19	80	192	10	*2
20	28.3	22	20	80	224	10	*2
21	29.5	22	21	80	226	10	*2
22	30.8	22	22	80	231	10	*2

13300A (inch)	D <sub>1</sub> (mm)	D <sub>2</sub> (mm)	(mm)	L (mm)	(g)	(pcs.)	
1/4	10.8	19	6	80	77	10	*1
5/16	13.3	19	8	80	82	10	*1
3/8	15.8	19	10	80	94	10	*1
7/16	17	19	11	80	110	10	*1
1/2	19.5	22	13	80	138	10	*2
9/16	20.8	22	14	80	148	10	*2
5/8	23.3	22	16	80	156	10	*2
11/16	24.5	22	17	80	168	10	*2
3/4	27	22	19	80	192	10	*2
13/16	29.5	22	21	80	226	10	*2
7/8	30.8	22	22	80	231	10	*2

\*1 C-Ring=1301C, Pin/O-Ring=1301A/B

\*2 C-Ring=1302C, Pin/O-Ring=1302A/B

→ P232-233

## 13300M · 13300A 6-point Sockets, deep Vasos Hexagonales Largos

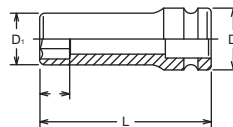

HAND MANUALES  
Z-SERIES  
TITANIUM DE TITANIO  
ACCESSORIES ACCESORIOS  
SCREWDRIVERS DESTORNILLADORES  
IMPACT DE IMPACTO  
SLEEVE-DRIVE INDUSTRIAL INDUSTRIALES  
AUTOMOTIVE  
CONSTRUCTION CONSTRUCCION  
RENEWAL KITS JUEGOS DE PIEZAS REPUESTO

# Impact Sockets **3/8"**

HAND MANUALES  
Z-SERIES  
TITANIUM DE TITANIO  
ACCESSORIES ACCESORIOS  
SCREWDRIVERS DESTORNILLADORES  
IMPACT DE IMPACTO  
SLEEVE-DRIVE  
INDUSTRIAL INDUSTRIALES  
AUTOMOTIVE  
CONSTRUCTION CONSTRUCCION  
RENEWAL KITS JUEGOS DE PIEZAS REPLUSTO

## 13301M • 13301A

6-point Deep Sockets, Thin Walled  
Vasos Hexagonales Largos de Pared Delgada

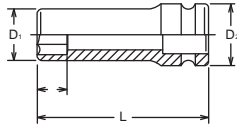

13301M (mm)	D <sub>1</sub> (mm)	D <sub>2</sub> (mm)	(mm)	L (mm)	(g)	(pcs.)	
6	10	18.5	6	80	65	10	*1
7	11	18.5	7	80	66	10	*1
8	12.3	18.5	8	80	68	10	*1
9	13.5	18.5	9	80	70	10	*1
10	14.8	18.5	10	80	72	10	*1
11	16	18.5	11	80	80	10	*1
12	17.3	18.5	12	80	85	10	*1
13	18.5	21.5	13	80	100	10	*2
14	19.8	21.5	14	80	110	10	*2
15	21	21.5	15	80	120	10	*2
16	22.3	21.5	16	80	130	10	*2
17	23.5	21.5	17	80	136	10	*2
18	24.8	21.5	18	80	145	10	*2
19	26	21.5	19	80	155	10	*2
20	27.3	21.5	20	80	170	10	*2
21	28.5	21.5	21	80	181	10	*2
22	29.8	21.5	22	80	190	10	*2

## 13305M

12-point Sockets, deep  
Vasos Bihexagonales Largos

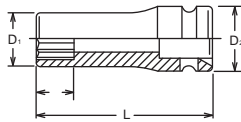

13301A (inch)	D <sub>1</sub> (mm)	D <sub>2</sub> (mm)	(mm)	L (mm)	(g)	(pcs.)	
1/4	10	18.5	6	80	65	10	*1
5/16	12.3	18.5	8	80	68	10	*1
3/8	14.8	18.5	10	80	72	10	*1
7/16	16	18.5	11	80	80	10	*1
1/2	18.5	21.5	13	80	100	10	*2
9/16	19.8	21.5	14	80	110	10	*2
5/8	22.3	21.5	16	80	130	10	*2
11/16	23.5	21.5	17	80	136	10	*2
3/4	26	21.5	19	80	155	10	*2
13/16	28.5	21.5	21	80	181	10	*2
7/8	29.8	21.5	22	80	190	10	*2

\*1 C-Ring=1301C, Pin/O-Ring=1301A/B  
\*2 C-Ring=1302C, Pin/O-Ring=1302A/B → P232-233

13305M (mm)	D <sub>1</sub> (mm)	D <sub>2</sub> (mm)	(mm)	L (mm)	(g)	(pcs.)	
8	13.3	19	8	80	82	10	*1
10	15.8	19	10	80	94	10	*1
12	18.3	19	12	80	111	10	*1
13	19.5	22	13	80	138	10	*2
14	20.8	22	14	80	148	10	*2
17	24.5	22	17	80	168	10	*2

\*1 C-Ring=1301C, Pin/O-Ring=1301A/B  
\*2 C-Ring=1302C, Pin/O-Ring=1302A/B → P232-233

## 13300G

Impact Sockets with Sliding Magnet  
Vasos de Impacto con Imán Corredizo

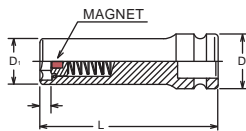

13300G (mm)	D <sub>1</sub> (mm)	D <sub>2</sub> (mm)	(mm)	L (mm)	(g)	(pcs.)	
8	13.3	19	4	80	82	10	*1
10	15.8	19	4.5	80	105	10	*1
12	18.3	19	6	80	136	10	*1
13	19.5	22	6.5	80	165	10	*2
14	20.8	22	7	80	186	10	*2
15	22	22	7	80	195	10	*2
17	24.5	22	8	80	220	10	*2
19	27	22	9	80	230	10	*2

\*1 C-Ring=1301C, Pin/O-Ring=1301A/B  
\*2 C-Ring=1302C, Pin/O-Ring=1302A/B → P232-233

## 13310M

Surface Drive Sockets, deep  
Vasos Surface Drive (de Contacto Curvo) Largos

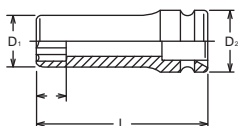
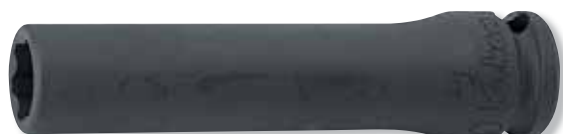

13310M (mm)	D <sub>1</sub> (mm)	D <sub>2</sub> (mm)	(mm)	L (mm)	(g)	(pcs.)	
7	11	18.5	7	80	70	10	*1
8	13.3	19	8	80	90	10	*1
9	14.5	19	9	80	90	10	*1
10	15.8	19	10	80	97	10	*1
11	17	19	11	80	110	10	*1
12	18.3	19	12	80	105	10	*1
13	19.5	22	13	80	135	10	*2
14	20.8	22	14	80	145	10	*2
15	22	22	15	80	160	10	*2
16	23.3	22	16	80	156	10	*2
17	24.5	22	17	80	168	10	*2
19	27	22	19	80	190	10	*2

\*1 C-Ring=1301C, Pin/O-Ring=1301A/B  
\*2 C-Ring=1302C, Pin/O-Ring=1302A/B → P232-233



13365M (mm)	D <sub>1</sub> (mm)	D <sub>2</sub> (mm)	(mm)	L (mm)	(g)	(pcs.)	
10	15.8	19	8	80	99	10	*1
11	17	19	8	80	108	10	*1
12	18.3	19	9	80	110	10	*1
13	19.5	22	9	80	142	10	*2
14	20.8	22	11	80	144	10	*2
15	22	22	11	80	150	10	*2
16	23.3	22	11	80	159	10	*2
17	24.5	22	12	80	170	10	*2
18	25.8	22	13	80	201	10	*2
19	27	22	13	80	203	10	*2

\*1 C-Ring=1301C, Pin/O-Ring=1301A/B  
 \*2 C-Ring=1302C, Pin/O-Ring=1302A/B → P232-233

## 13365M Pathfinder Sockets deep Vasos Pathfinder (Guía) Largos

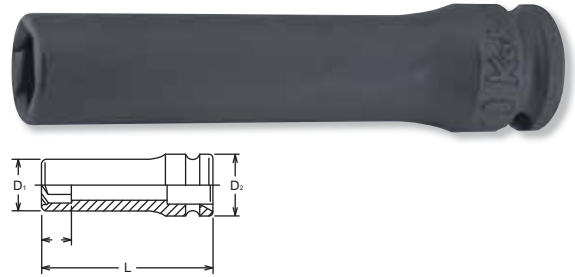

13440M (mm)	D (mm)	(mm)	L (mm)	(g)	(pcs.)	
10	15.8	5	57	115	10	*1
11	17	6	57	115	10	*1
12	18.3	6	57	115	10	*1
13	19.5	6	57	115	10	*1
14	20.8	7	59	120	10	*1
15	22	7	59	120	10	*1
16	23.3	8	59	120	10	*1
17	24.5	8	59	120	10	*1
18	25.8	9	61	126	10	*1
19	27	10	61	130	10	*1
20	29.5	10	61	135	10	*1
22	32	13	61	185	10	*1
24	34.5	13	63	190	10	*1

13440A (inch)	D (mm)	(mm)	L (mm)	(g)	(pcs.)	
3/8	15.8	5	57	115	10	*1
7/16	17	6	57	115	10	*1
1/2	19.5	6	57	115	10	*1
9/16	20.8	7	59	120	10	*1
5/8	23.3	8	59	120	10	*1
11/16	24.5	8	59	120	10	*1
3/4	27	10	61	130	10	*1

\*1 C-Ring=1302C, Pin/O-Ring=1302A/B → P232-233

## 13440M • 13440A Universal Sockets Vasos con Articulación Universal



13440T (E)	D (mm)	(mm)	L (mm)	(g)	(pcs.)	
E10	13.3	8.2	58	115	10	*1
E12	15.8	9.3	58	115	10	*1
E14	17	10.6	58	115	10	*1

\*1 C-Ring=1302C, Pin/O-Ring=1302A/B → P232-233

## 13440T TORX® Universal Sockets Vasos TORX® con Articulación Universal

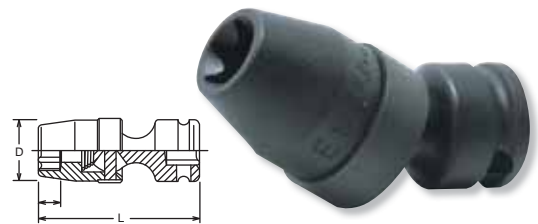

13430M (mm)	D (mm)	(mm)	L (mm)	(g)	(pcs.)	
5	24	15	74	120	10	*1
6	24	15	74	131	10	*1
8	24	20	74	136	10	*1
10	24	20	74	141	10	*1
17	24	7	53	150	10	*1

\*1 C-Ring=1302C, Pin/O-Ring=1302A/B → P232-233

## 13430M Universal Inhex Sockets Vasos Inhex con Articulación Universal



# Impact Sockets **3/8"**

HAND MANUALES  
Z-SERIES  
TITANIUM DE TITANIO  
ACCESSORIES ACCESORIOS  
SCREWDRIVERS DESTORNILLADORES  
IMPACT DE IMPACTO  
SLEEVE-DRIVE  
INDUSTRIAL INDUSTRIALES  
AUTOMOTIVE  
CONSTRUCTION CONSTRUCCION  
RENEWAL KITS JUEGOS DE PIEZAS/REPLUSTO

## 13012M-52 Inhex Sockets Vasos con Punta Hexagonal



13012M.52 (mm)	D (mm)	(mm)	L (mm)	(g)	(pcs.)	
4	18	15.5	52	35	10	*1
5	18	15.5	52	35	10	*1
6	18	15.5	52	39	10	*1
New 7	18	15.5	52	44	10	*1
8	21	15.5	52	60	10	*2
10	21	15.5	52	70	10	*2
12	21	15.5	52	79	10	*2
New 14	21	15.5	52	92	10	*2

\*1 C-Ring=1301C, Pin/O-Ring=1301A/B → P232-233  
\*2 C-Ring=1302C, Pin/O-Ring=1302A/B

## 13025-50 TORX® Bit Sockets Vasos con Punta TORX®



13025.50 (T)	D (mm)	L (mm)	(g)	(pcs.)	
T20	19	50	35	10	*1
T25	19	50	35	10	*1
T27	19	50	38	10	*1
T30	19	50	38	10	*1
T40	19	50	45	10	*1
T45	19	50	45	10	*1
T50	19	50	50	10	*1
T55	22	50	72	10	*2

\*1 C-Ring=1301C, Pin/O-Ring=1301A/B → P232-233  
\*2 C-Ring=1302C, Pin/O-Ring=1302A/B

## RS13025/8-L50 Socket Set on Rail Juego de Vasos en Regleta



RS13025/8-L50	8 Pieces Set/Rail 200mm	(g)
T20, T25, T27, T30, T40, T45, T50, T55		380

## 13105-11 Hex Bit Sockets Vasos con Punta Hexagonal



13105.11 (mm)	L (mm)	(g)	(pcs.)	
3	54	87	10	*1
4	54	87	10	*1
5	54	88	10	*1
6	54	89	10	*1
7	54	90	10	*1
8	54	92	10	*1
10	54	96	10	*1
12	54	101	10	*1
14	54	108	10	*1
17	54	120	10	*1
19	54	128	10	*1

## 13105-11 (T) TORX® Bit Sockets Vasos con Punta TORX®



13105.11 (inch)	L (mm)	(g)	(pcs.)	
1/4	54	89	10	*1
5/16	54	92	10	*1
3/8	54	96	10	*1
1/2	54	108	10	*1
3/4	54	128	10	*1

\*1 C-Ring=1302C, Pin/O-Ring=1302A/B → P232-233

## 13105 Bit Holder, For 107-11 Porta Punta

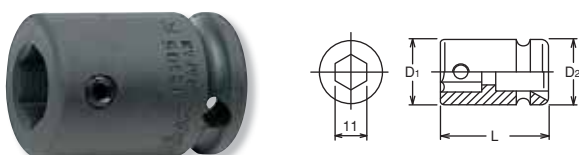

13105.11 (T)	L (mm)	(g)	(pcs.)	
T25	54	87	10	*1
T30	54	87	10	*1
T40	54	87	10	*1
T45	54	87	10	*1
T50	54	92	10	*1
T55	54	96	10	*1
T60	54	101	10	*1

\*1 C-Ring=1302C, Pin/O-Ring=1302A/B → P232-233

13105	D <sub>1</sub> (mm)	D <sub>2</sub> (mm)	L (mm)	(g)	(pcs.)	
13105	22	22	32	70	10	*1

\*1 C-Ring=1302C, Pin/O-Ring=1302A/B → P232-233

 Replacement Screw : M5x6, ●2.5mm

107.11 (mm)	L (mm)	(g)	(pcs.)
3	35	15	10
4	35	16	10
5	35	16	10
6	35	18	10
7	35	19	10
8	35	20	10
10	35	26	10
11	35	28	10
12	35	31	10
14	35	38	10
16	35	47	10
17	35	50	10
18	35	53	10
19	35	56	10

107.11(L80) (mm)	L (mm)	(g)	(pcs.)
4	80	54	10
5	80	54	10
6	80	56	10
7	80	57	10
8	80	59	10
10	80	64	10
11	80	66	10
12	80	76	10
14	80	98	10

107.11 (T)	L (mm)	(g)	(pcs.)
T25	35	18	10
T30	35	18	10
T40	35	20	10
T45	35	22	10
T50	35	26	10
T55	35	31	10
T60	35	38	10

107.11(L80) (T)	L (mm)	(g)	(pcs.)
T30	80	54	10
T40	80	54	10
T45	80	56	10
T50	80	57	10
T55	80	66	10
T60	80	76	10

107.11 (XZN)	L (mm)	(g)	(pcs.)
M 4	35	18	10
M 5	35	20	10
M 6	35	22	10
M 8	35	26	10
M10	35	31	10
M12	35	38	10

107.11(L80) (XZN)	L (mm)	(g)	(pcs.)
M 4	80	54	10
M 5	80	54	10
M 6	80	56	10
M 8	80	57	10
M10	80	66	10
M12	80	76	10
M14	80	80	10

## 107-11 Bits for Inhex Screws Puntas para Tornillos de Seis Lados en el Interior (Inhex)

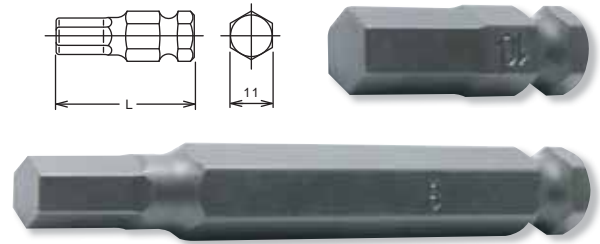

107.11 (inch)	L (mm)	(g)	(pcs.)
3/16	35	15	10
7/32	35	16	10
1/4	35	18	10
5/16	35	20	10
3/8	35	26	10
7/16	35	28	10
1/2	35	38	10
5/8	35	47	10
3/4	35	56	10

## 107-11 (T) TORX® Bits Puntas TORX®



## 107-11 (XZN) XZN Bits Puntas XZN

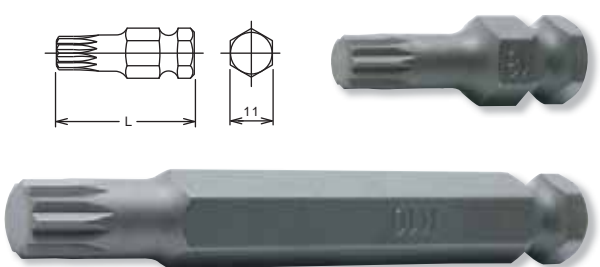

HAND MANUALES  
Z-SERIES  
TITANIUM DE TITANIO  
ACCESSORIES ACCESORIOS  
SCREWDRIVERS DESTORNILLADORES  
IMPACT DE IMPACTO  
SLEEVE-DRIVE INDUSTRIAL INDUSTRIALES  
AUTOMOTIVE  
CONSTRUCTION CONSTRUCCION  
RENEWAL KITS JUEGOS DE PIEZAS REPUESTO

HAND MANUALES  
Z-SERIES  
TITANIUM DE TITANIO  
ACCESSORIES ACCESORIOS  
SCREWDRIVERS DESTORNILLADORES  
IMPACT DE IMPACTO  
SLEEVE-DRIVE  
INDUSTRIAL INDUSTRIALES  
AUTOMOTIVE  
CONSTRUCTION CONSTRUCCION  
RENEWAL KITS JUEGOS DE PIEZAS/REPLUSTO

## 13145M-100 · -150 · -200 · -250

Extra Long Sockets  
Vasos Extra-Largos

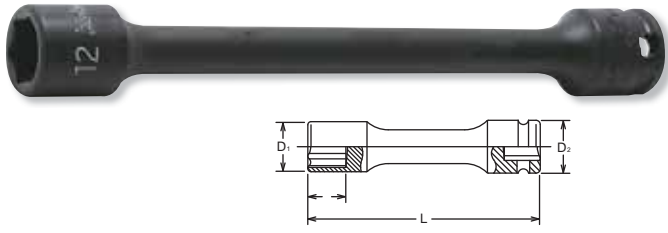

13145M.100 (mm)	D <sub>1</sub> (mm)	D <sub>2</sub> (mm)	(mm)	L (mm)	(g)	(pce.)	
8	13.3	19	8	100	90	1	*1
10	15.8	19	10	100	92	1	*1
12	18.3	19	12	100	100	1	*1
13	19.5	19	13	100	108	1	*1
14	20.8	19	14	100	112	1	*1
17	24.5	19	17	100	140	1	*1

13145M.150 (mm)	D <sub>1</sub> (mm)	D <sub>2</sub> (mm)	(mm)	L (mm)	(g)	(pce.)	
6	10.8	19	6	150	105	1	*1
8	13.3	19	8	150	110	1	*1
10	15.8	19	10	150	120	1	*1
12	18.3	19	12	150	128	1	*1
13	19.5	19	13	150	137	1	*1
14	20.8	19	14	150	146	1	*1
15	22	19	15	150	155	1	*1
17	24.5	19	17	150	163	1	*1

13145M.200 (mm)	D <sub>1</sub> (mm)	D <sub>2</sub> (mm)	(mm)	L (mm)	(g)	(pce.)	
6	10.8	19	6	200	136	1	*1
8	13.3	19	8	200	141	1	*1
10	15.8	19	10	200	151	1	*1
12	18.3	19	12	200	159	1	*1
13	19.5	19	13	200	168	1	*1
14	20.8	19	14	200	177	1	*1
15	22	19	15	200	186	1	*1
17	24.5	19	17	200	194	1	*1

13145M.250 (mm)	D <sub>1</sub> (mm)	D <sub>2</sub> (mm)	(mm)	L (mm)	(g)	(pce.)	
6	10.8	19	6	250	167	1	*1
8	13.3	19	8	250	172	1	*1
10	15.8	19	10	250	182	1	*1
12	18.3	19	12	250	190	1	*1
13	19.5	19	13	250	199	1	*1
14	20.8	19	14	250	208	1	*1
15	22	19	15	250	217	1	*1
17	24.5	19	17	250	225	1	*1

\*1 C-Ring=1301C, Pin/O-Ring=1301A/B → P232-233

## 13145M-100 (12P) · -150 (12P) · -200 (12P)

Extra Long 12-Point Sockets  
Vasos Bihexagonales, Extra-Largos

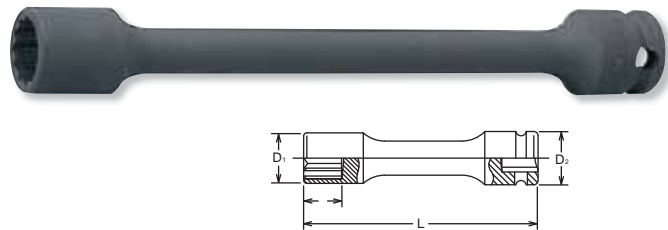

13145M.100 (12P) (mm)	D <sub>1</sub> (mm)	D <sub>2</sub> (mm)	(mm)	L (mm)	(g)	(pce.)	
10	15.8	19	10	100	91	1	*1
12	18.3	19	12	100	100	1	*1

13145M.150 (12P) (mm)	D <sub>1</sub> (mm)	D <sub>2</sub> (mm)	(mm)	L (mm)	(g)	(pce.)	
10	15.8	19	10	150	120	1	*1
12	18.3	19	12	150	128	1	*1

13145M.200 (12P) (mm)	D <sub>1</sub> (mm)	D <sub>2</sub> (mm)	(mm)	L (mm)	(g)	(pce.)	
10	15.8	19	10	200	151	1	*1
12	18.3	19	12	200	159	1	*1

\*1 C-Ring=1301C, Pin/O-Ring=1301A/B → P232-233

## 13145MG-100 · -150 · -200

Extra Long Sockets with Magnet  
Vasos Extra-Largos con Imán

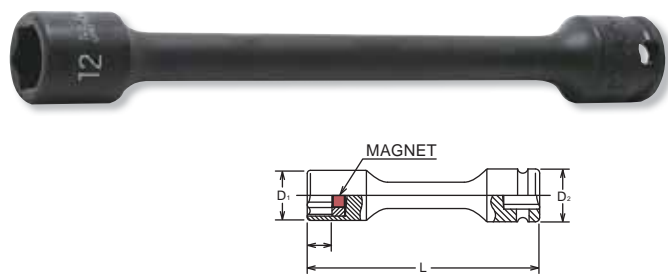

13145MG.100 (mm)	D <sub>1</sub> (mm)	D <sub>2</sub> (mm)	(mm)	L (mm)	(g)	(pce.)	
8	13.3	19	3.5	100	90	1	*1
10	15.8	19	4.2	100	93	1	*1
12	18.3	19	5.6	100	105	1	*1
13	19.5	19	6	100	115	1	*1
14	20.8	19	6.4	100	120	1	*1

13145MG.150 (mm)	D <sub>1</sub> (mm)	D <sub>2</sub> (mm)	(mm)	L (mm)	(g)	(pce.)	
10	15.8	19	4.2	150	125	1	*1
12	18.3	19	5.6	150	136	1	*1
13	19.5	19	6	150	145	1	*1
14	20.8	19	6.4	150	150	1	*1

13145MG.200 (mm)	D <sub>1</sub> (mm)	D <sub>2</sub> (mm)	(mm)	L (mm)	(g)	(pce.)	
10	15.8	19	4.2	200	182	1	*1
12	18.3	19	5.6	200	190	1	*1
13	19.5	19	6	200	208	1	*1
14	20.8	19	6.4	200	225	1	*1

\*1 C-Ring=1301C, Pin/O-Ring=1301A/B → P232-233

13146M.150 (mm)	D <sub>1</sub> (mm)	D <sub>2</sub> (mm)	(mm)	L (mm)	(g)	(pce.)	⚡
8	12	19	6	150	128	1	*1
10	14.3	19	7	150	131	1	*1
12	18	19	8	150	133	1	*1
13	19.3	19	8.5	150	132	1	*1
14	20	19	9	150	132	1	*1

13146M.200 (mm)	D <sub>1</sub> (mm)	D <sub>2</sub> (mm)	(mm)	L (mm)	(g)	(pce.)	⚡
8	12	19	6	200	159	1	*1
10	14.3	19	7	200	162	1	*1
12	18	19	8	200	164	1	*1
13	19.3	19	8.5	200	163	1	*1
14	20	19	9	200	163	1	*1

13146M.250 (mm)	D <sub>1</sub> (mm)	D <sub>2</sub> (mm)	(mm)	L (mm)	(g)	(pce.)	⚡
8	12	19	6	250	190	1	*1
10	14.3	19	7	250	193	1	*1
12	18	19	8	250	195	1	*1
13	19.3	19	8.5	250	194	1	*1
14	20	19	9	250	194	1	*1

\*1 C-Ring=1301C, Pin/O-Ring=1301A/B → P232-233

## 13146M-150 · -200 · -250

Extra Long Universal Sockets  
Vasos Extra Largo con Articulación Universal

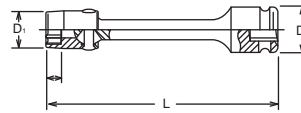

13147M.150 (mm)	D <sub>1</sub> (mm)	D <sub>2</sub> (mm)	(mm)	L (mm)	(g)	(pce.)	⚡
4	21	19	15	150	125	1	*1
5	21	19	15	150	128	1	*1
6	21	19	15	150	132	1	*1
8	21	19	15	150	136	1	*1
10	21	19	15	150	140	1	*1

13147M.200 (mm)	D <sub>1</sub> (mm)	D <sub>2</sub> (mm)	(mm)	L (mm)	(g)	(pce.)	⚡
4	21	19	15	200	156	1	*1
5	21	19	15	200	159	1	*1
6	21	19	15	200	163	1	*1
8	21	19	15	200	167	1	*1
10	21	19	15	200	171	1	*1

\*1 C-Ring=1301C, Pin/O-Ring=1301A/B → P232-233

## 13147M-150 · -200

Extra Long Universal Inhex Sockets  
Vasos Inhex Extra Largos con Articulación Universal

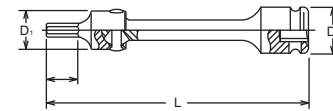

13760	D (mm)	L (mm)	(g)	(pcs.)	⚡
75	22	75	95	10	*1
100	22	100	120	10	*1
125	22	125	141	10	*1
150	22	150	165	10	*1
200	22	200	210	10	*1
250	22	250	260	10	*1

\*1 C-Ring=1302C, Pin/O-Ring=1302A/B → P232-233

## 13760-75 · -100 · -125 · -150 · -200 · -250

Extension Bars  
Alargaderas

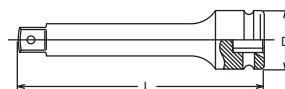

HAND  
MANUALES

Z-SERIES

TITANIUM  
DE TITANIO

ACCESSORIES  
ACCESORIOS

SCREWDRIVERS  
DESTORNILLADORES

IMPACT  
DE IMPACTO

SLEEVE-DRIVE

INDUSTRIAL  
INDUSTRIALES

AUTOMOTIVE

CONSTRUCTION  
CONSTRUCCION

RENEWAL KITS  
JUEGOS DE PIEZAS REPUESTO



# Impact Sockets **3/8"**

HAND MANUALES  
Z-SERIES  
TITANIUM DE TITANIO  
ACCESSORIES ACCESORIOS  
SCREWDRIVERS DESTORNILLADORES  
IMPACT DE IMPACTO  
SLEEVE-DRIVE  
INDUSTRIAL INDUSTRIALES  
AUTOMOTIVE  
CONSTRUCTION CONSTRUCCION  
RENEWAL KITS JUEGOS DE PIEZAS REPLÉSTO

## 13333AL Adaptor (Quick Release) Adaptador (Extracción Rápida)



## 13770 Universal Joint Articulación Universal



## 13771 Universal Joint Articulación Universal



## 13772-P Universal Joint Articulación Universal



## 13322A Adaptor Adaptador



## 13344A Adaptor Adaptador



## 13241M Socket Set Juego de Vasos



## 13242M Socket Set Juego de Vasos



### Lock & Quick Release

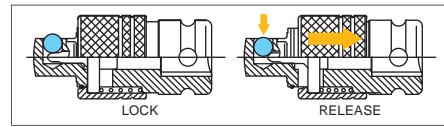

	L (mm)	(g)	(pcs.)	
13333AL	45	62	10	*1

\*1 C-Ring=1301C, Pin/O-Ring=1301A/B → P232-233

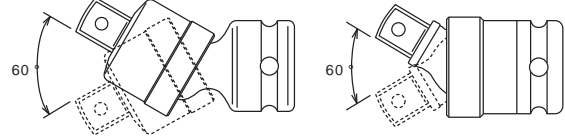

	L (mm)	(g)	(pcs.)	
13770	56	110	10	*1
13770-B	56	110	10	*1
13770-P	56	110	10	*1
13771	48	92	10	*1
13771-B	48	92	10	*1
13771-P	48	92	10	*1

\*1 C-Ring=1302C, Pin/O-Ring=1302A/B → P232-233



	D <sub>1</sub> (mm)	D <sub>2</sub> (mm)	L (mm)	(g)	(pcs.)	
13772-P	22	19	75	120	5	*1

\*1 C-Ring=1301C, Pin/O-Ring=1301A/B → P232-233

	(sq.)	(sq.)	L (mm)	(g)	(pcs.)	
13322A	3/8"	1/4"	25	25	10	*1
13322A-B	3/8"	1/4"	25	25	10	*1
13322A-P	3/8"	1/4"	25	25	10	*1

\*1 C-Ring=1301CC, Pin/O-Ring=1301A/B → P232-233

⚠ Adapting down from bigger square drive to smaller square drive may lead to excessive torque load and possibly cause breakage. Always stay within safe torque of the smaller square drive.

	(sq.)	(sq.)	L (mm)	(g)	(pcs.)	
13344A	3/8"	1/2"	32.5	53	10	*1
13344A-B	3/8"	1/2"	32.5	53	10	*1
13344A-P	3/8"	1/2"	32.5	53	10	*1

\*1 C-Ring=1302C, Pin/O-Ring=1302A/B → P232-233

13241M 11 Pieces Set/△=850g

METAL CASE:W240xH30xT35mm

Sockets

13400M 6-pt. Sockets  
9, 10, 11, 12, 13, 14, 15, 16, 17, 18, 19

13242M 11 Pieces Set/△=1,140g

METAL CASE:W310xH90xT48mm

Sockets

13400M 6-pt. Sockets  
9, 10, 11, 12, 13, 14, 15, 16, 17, 18, 19

14400M (mm)	D <sub>1</sub> (mm)	D <sub>2</sub> (mm)	(mm)	L (mm)	(g)	(pcs.)	
8	14.5	25	6	38	85	10	*1
9	15.7	25	7	38	85	10	*1
10	17	25	7	38	85	10	*1
11	18.2	25	8	38	85	10	*1
12	19.5	25	9	38	85	10	*1
13	20.7	25	10	38	85	10	*1
14	22	25	10	38	85	10	*1
15	23.2	30	11	38	130	10	*2
16	24.5	30	11	38	130	10	*2
17	25.7	30	12	38	130	10	*2
18	27	30	13	38	130	10	*2
19	28.2	30	13	38	125	10	*2
20	29.5	30	13	38	127	10	*2
21	30.7	30	14	38	120	10	*2
22	32	30	14	38	130	10	*2
23	33.2	30	14	38	130	10	*2
24	34.5	30	14	38	135	10	*2
25	35.7	30	14	38	135	10	*2
26	37	30	14	38	160	10	*2
27	38.2	30	16	40	160	10	*2
28	39.5	30	16	40	170	10	*2
29	40.7	30	17	42	190	10	*2
30	42	30	17	42	190	10	*2
31	43.2	30	17	42	213	10	*2
32	44.5	30	18	42	216	10	*2
33	45.7	30	19	46	260	5	*2
34	47	30	19	46	263	5	*2
35	48.2	30	19	46	275	5	*2
36	49.5	30	20	46	285	5	*2
41	55.7	30	21	55	411	2	*2

\*1 C-Ring=1401C, Pin/O-Ring=1401A/B  
 \*2 C-Ring=1402C, Pin/O-Ring=1402A/B → P232-233

## 14400M • 14400A

6-point Sockets  
Vasos Hexagonales

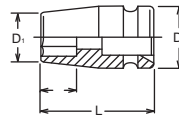

14400A (inch)	D <sub>1</sub> (mm)	D <sub>2</sub> (mm)	(mm)	L (mm)	(g)	(pcs.)	
New 1/4	12	25	5	38	80	10	*1
5/16	14.5	25	6	38	85	10	*1
3/8	17	25	7	38	85	10	*1
7/16	18.2	25	8	38	85	10	*1
1/2	20.7	25	10	38	85	10	*1
9/16	22	25	10	38	85	10	*1
5/8	24.5	30	11	38	130	10	*2
11/16	25.7	30	12	38	130	10	*2
3/4	28.2	30	13	38	125	10	*2
13/16	30.7	30	14	38	120	10	*2
7/8	32	30	14	38	130	10	*2
15/16	34.5	30	14	38	135	10	*2
1	35.7	30	14	38	135	10	*2
1. 1/16	38.2	30	16	40	160	10	*2
1. 1/8	40.7	30	17	42	190	10	*2
1. 3/16	42	30	17	42	190	10	*2
1. 1/4	44.5	30	18	42	216	10	*2
1. 5/16	45.7	30	19	46	260	5	*2
1. 3/8	47	30	19	46	263	5	*2
1. 1/2	52	30	20	53	365	5	*2

\*1 C-Ring=1401C, Pin/O-Ring=1401A/B  
 \*2 C-Ring=1402C, Pin/O-Ring=1402A/B → P232-233

14405M (mm)	D <sub>1</sub> (mm)	D <sub>2</sub> (mm)	(mm)	L (mm)	(g)	(pcs.)	
8	14.5	25	6	38	85	10	*1
9	15.7	25	7	38	85	10	*1
10	17	25	7	38	85	10	*1
11	18.2	25	8	38	84	10	*1
12	19.5	25	9	38	84	10	*1
13	20.7	25	10	38	84	10	*1
14	22	25	10	38	84	10	*1
15	23.2	30	11	38	130	10	*2
16	24.5	30	11	38	127	10	*2
17	25.7	30	12	38	128	10	*2
18	27	30	13	38	130	10	*2
19	28.2	30	13	38	125	10	*2
20	29.5	30	13	38	127	10	*2
21	30.7	30	14	38	120	10	*2
22	32	30	14	38	130	10	*2
23	33.2	30	14	38	132	10	*2
24	34.5	30	14	38	133	10	*2
26	37	30	14	38	147	10	*2
27	38.2	30	16	40	157	10	*2
28	39.5	30	16	40	170	10	*2
30	42	30	17	42	190	10	*2
32	44.5	30	18	42	216	10	*2
36	49.5	30	20	46	285	5	*2

\*1 C-Ring=1401C, Pin/O-Ring=1401A/B  
 \*2 C-Ring=1402C, Pin/O-Ring=1402A/B → P232-233

## 14405M • 14405A

12-point Sockets  
Vasos Bihexagonales

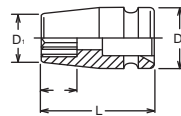

14405A (inch)	D <sub>1</sub> (mm)	D <sub>2</sub> (mm)	(mm)	L (mm)	(g)	(pcs.)	
5/16	14.5	25	6	38	85	10	*1
3/8	17	25	7	38	85	10	*1
7/16	18.2	25	8	38	85	10	*1
1/2	20.7	25	10	38	85	10	*1
9/16	22	25	10	38	85	10	*1
5/8	24.5	30	11	38	130	10	*2
11/16	25.7	30	12	38	130	10	*2
3/4	28.2	30	13	38	125	10	*2
13/16	30.7	30	14	38	120	10	*2
7/8	32	30	14	38	130	10	*2
15/16	34.5	30	14	38	135	10	*2
1	35.7	30	14	38	135	10	*2
1. 1/16	38.2	30	16	40	160	10	*2
1. 1/8	40.7	30	17	42	190	10	*2
1. 3/16	42	30	17	42	190	10	*2
1. 1/4	44.5	30	18	42	216	10	*2
1. 5/16	45.7	30	19	46	260	5	*2
1. 3/8	47	30	19	46	263	5	*2
1. 1/2	52	30	20	53	365	5	*2

\*1 C-Ring=1401C, Pin/O-Ring=1401A/B  
 \*2 C-Ring=1402C, Pin/O-Ring=1402A/B → P232-233

HAND MANUALES  
 Z-SERIES  
 TITANIUM DE TITANIO  
 ACCESSORIES ACCESORIOS  
 SCREWDRIVERS DESTORNILLADORES  
 IMPACT DE IMPACTO  
 SLEEVE-DRIVE INDUSTRIAL INDUSTRIALES  
 AUTOMOTIVE  
 CONSTRUCTION CONSTRUCCION  
 RENEWAL KITS JUEGOS DE PIZAS REPUESTO

# Impact Sockets 1/2"

HAND MANUALES  
Z-SERIES  
TITANIUM DE TITANIO  
ACCESSORIES ACCESORIOS  
SCREWDRIVERS DESTORNILLADORES  
IMPACT DE IMPACTO  
SLEEVE-DRIVE  
INDUSTRIAL INDUSTRIALES  
AUTOMOTIVE  
CONSTRUCTION CONSTRUCCION  
RENEWAL KITS JUEGOS DE PIEZAS REPLISTO

## 14401M • 14401A

6-point Sockets, Thin Walled  
Vasos Hexagonales de Pared Delgada

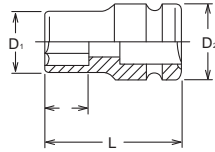

14401A (inch)	D <sub>1</sub> (mm)	D <sub>2</sub> (mm)	(mm)	L (mm)	(g)	(pcs.)	⚡
New 1/4	10.5	24	5	38	55	10	*1
5/16	13	24	6	38	57	10	*1
3/8	15.5	24	7	38	60	10	*1
7/16	16.7	24	8	38	62	10	*1
1/2	19.2	24	10	38	65	10	*1
9/16	20.5	24	10	38	67	10	*1
5/8	23	29	11	38	102	10	*2
11/16	24.2	29	12	38	105	10	*2
3/4	26.7	29	13	38	107	10	*2
13/16	29.2	29	14	38	109	10	*2
7/8	30.5	29	14	38	114	10	*2
15/16	33	29	14	38	122	10	*2
1	34.2	29	14	38	129	10	*2
1. 1/16	35.5	29	14	40	131	10	*2
1. 1/8	39.2	29	17	42	165	10	*2
1. 3/16	40.5	29	17	42	178	10	*2
1. 1/4	43	29	18	42	188	10	*2
1. 5/16	44.2	29	19	46	219	5	*2
1. 3/8	45.5	29	19	46	248	5	*2

\*1 C-Ring=1401C, Pin/O-Ring=1401A/B  
\*2 C-Ring=1402C, Pin/O-Ring=1402A/B

→ P232-233

14401M (mm)	D <sub>1</sub> (mm)	D <sub>2</sub> (mm)	(mm)	L (mm)	(g)	(pcs.)	⚡
8	13	24	6	38	57	10	*1
9	14.2	24	7	38	58	10	*1
10	15.5	24	7	38	60	10	*1
11	16.7	24	8	38	62	10	*1
12	18	24	9	38	63	10	*1
13	19.2	24	10	38	65	10	*1
14	20.5	24	10	38	67	10	*1
15	21.7	29	11	38	100	10	*2
16	23	29	11	38	102	10	*2
17	24.2	29	12	38	105	10	*2
18	25.5	29	13	38	105	10	*2
19	26.7	29	13	38	107	10	*2
20	28	29	13	38	108	10	*2
21	29.2	29	14	38	109	10	*2
22	30.5	29	14	38	114	10	*2
23	31.7	29	14	38	118	10	*2
24	33	29	14	38	122	10	*2
25	34.2	29	14	38	129	10	*2
26	35.5	29	14	38	131	10	*2
27	36.7	29	16	40	145	10	*2
28	38	29	16	40	152	10	*2
29	39.2	29	17	42	165	10	*2
30	40.5	29	17	42	178	10	*2
31	41.7	29	17	42	185	10	*2
32	43	29	18	42	188	10	*2
33	44.2	29	19	46	219	5	*2
34	45.5	29	19	46	248	5	*2
36	48	29	20	46	264	5	*2

\*1 C-Ring=1401C, Pin/O-Ring=1401A/B  
\*2 C-Ring=1402C, Pin/O-Ring=1402A/B

→ P232-233

## 14406M • 14406A

12-point Sockets, Thin Walled  
Vasos Bihexagonales de Pared Delgada

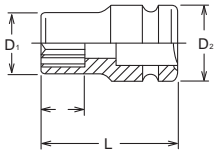

14406A (inch)	D <sub>1</sub> (mm)	D <sub>2</sub> (mm)	(mm)	L (mm)	(g)	(pcs.)	⚡
New 1/4	10.5	24	5	38	55	10	*1
5/16	13	24	6	38	57	10	*1
3/8	15.5	24	7	38	60	10	*1
7/16	16.7	24	8	38	62	10	*1
1/2	19.2	24	10	38	65	10	*1
9/16	20.5	24	10	38	67	10	*1
5/8	23	29	11	38	102	10	*2
11/16	24.2	29	12	38	105	10	*2
3/4	26.7	29	13	38	107	10	*2
13/16	29.2	29	14	38	109	10	*2
7/8	30.5	29	14	38	114	10	*2
15/16	33	29	14	38	122	10	*2
1	34.2	29	14	38	129	10	*2
1. 1/16	35.5	29	14	40	131	10	*2
1. 1/8	39.2	29	17	42	165	10	*2
1. 3/16	40.5	29	17	42	178	10	*2
1. 1/4	43	29	18	42	188	10	*2
1. 5/16	44.2	29	19	46	219	5	*2
1. 3/8	45.5	29	19	46	248	5	*2

\*1 C-Ring=1401C, Pin/O-Ring=1401A/B  
\*2 C-Ring=1402C, Pin/O-Ring=1402A/B

→ P232-233

14406M (mm)	D <sub>1</sub> (mm)	D <sub>2</sub> (mm)	(mm)	L (mm)	(g)	(pcs.)	⚡
8	13	24	6	38	57	10	*1
9	14.2	24	7	38	58	10	*1
10	15.5	24	7	38	60	10	*1
11	16.7	24	8	38	62	10	*1
12	18	24	9	38	63	10	*1
13	19.2	24	10	38	65	10	*1
14	20.5	24	10	38	67	10	*1
15	21.7	29	11	38	100	10	*2
16	23	29	11	38	102	10	*2
17	24.2	29	12	38	105	10	*2
18	25.5	29	13	38	105	10	*2
19	26.7	29	13	38	107	10	*2
20	28	29	13	38	108	10	*2
21	29.2	29	14	38	109	10	*2
22	30.5	29	14	38	114	10	*2
23	31.7	29	14	38	118	10	*2
24	33	29	14	38	122	10	*2
25	34.2	29	14	38	129	10	*2
26	35.5	29	14	38	131	10	*2
27	36.7	29	16	40	145	10	*2
28	38	29	16	40	152	10	*2
29	39.2	29	17	42	165	10	*2
30	40.5	29	17	42	178	10	*2
31	41.7	29	17	42	185	10	*2
32	43	29	18	42	188	10	*2
33	44.2	29	19	46	219	5	*2
34	45.5	29	19	46	248	5	*2
36	48	29	20	46	264	5	*2

\*1 C-Ring=1401C, Pin/O-Ring=1401A/B  
\*2 C-Ring=1402C, Pin/O-Ring=1402A/B

→ P232-233

## RS14401M/10

Socket Set on Rail  
Juego de Vasos en Regleta



RS14401M/10	10 Pieces Set/Rail 300mm	(g)
10, 12, 13, 14, 17, 19, 21, 22, 24, 27		1,010

14400MG (mm)	D <sub>1</sub> (mm)	D <sub>2</sub> (mm)	(mm)	L (mm)	(g)	(pcs.)	
8	14.5	25	3.5	38	95	10	*1
10	17	25	4.2	38	95	10	*1
12	19.5	25	5.6	38	100	10	*1
13	20.7	25	6	38	100	10	*1
14	22	25	6.4	38	105	10	*1
15	23.2	30	6.8	38	140	10	*2
16	24.5	30	7	38	145	10	*2
17	25.7	30	7.5	38	145	10	*2
18	27	30	7.8	38	147	10	*2
19	28.2	30	8	38	147	10	*2
21	30.7	30	13.5	38	165	10	*2

\*1 C-Ring=1401C, Pin/O-Ring=1401A/B  
\*2 C-Ring=1402C, Pin/O-Ring=1402A/B

14401LH (LH-S)	D <sub>1</sub> (mm)	D <sub>2</sub> (mm)	(mm)	L (mm)	(g)	(pcs.)	
6S	13	25	5.6	38	65	10	*1
8S	16.7	25	6.8	38	69	10	*1
10S	19.2	25	8	38	75	10	*1
12S	23	30	9.2	38	115	10	*2
14S	25.5	30	10.4	38	121	10	*2
16S	29.2	30	11.6	38	128	10	*2

\*1 C-Ring=1401C, Pin/O-Ring=1401A/B  
\*2 C-Ring=1402C, Pin/O-Ring=1402A/B

14410M (mm)	D <sub>1</sub> (mm)	D <sub>2</sub> (mm)	(mm)	L (mm)	(g)	(pcs.)	
10	17	25	7	38	100	10	*1
11	18.2	25	8	38	103	10	*1
12	19.5	25	9	38	110	10	*1
13	20.7	25	10	38	113	10	*1
14	22	25	10	38	115	10	*1
15	23.2	30	11	38	120	10	*2
16	24.5	30	11	38	120	10	*2
17	25.7	30	12	38	126	10	*2
18	27	30	13	38	121	10	*2
19	28.2	30	13	38	124	10	*2
20	29.5	30	13	38	123	10	*2
21	30.7	30	14	38	120	10	*2
22	32	30	14	38	130	10	*2
24	34.5	30	14	38	134	10	*2
25	35.7	30	14	38	135	10	*2
26	37	30	14	38	160	10	*2
27	38.2	30	16	40	160	10	*2
28	39.5	30	16	40	170	10	*2
29	40.7	30	17	42	190	10	*2
30	42	30	17	42	190	10	*2
31	43.2	30	17	42	213	10	*2
32	44.5	30	18	42	216	10	*2
34	47	30	19	46	263	5	*2
36	49.5	30	20	46	263	5	*2

\*1 C-Ring=1401C, Pin/O-Ring=1401A/B  
\*2 C-Ring=1402C, Pin/O-Ring=1402A/B

14465M (mm)	D <sub>1</sub> (mm)	D <sub>2</sub> (mm)	(mm)	L (mm)	(g)	(pcs.)	
10	17	25	8	38	89	10	*1
11	18.2	25	8	38	87	10	*1
12	19.5	25	9	38	87	10	*1
13	20.7	25	9	38	86	10	*1
14	22	25	11	38	86	10	*1
15	23.2	30	11	38	131	10	*2
16	24.5	30	11	38	131	10	*2
17	25.7	30	12	38	132	10	*2
18	27	30	13	38	128	10	*2
19	28.2	30	13	38	128	10	*2
20	29.5	30	14	38	125	10	*2
21	30.7	30	14	38	128	10	*2
22	32	30	15	38	130	10	*2
23	33.2	30	15	38	135	10	*2
24	34.5	30	15	38	135	10	*2
25	35.7	30	15	38	133	10	*2
26	37	30	15	38	152	10	*2
27	38.2	30	16	40	169	10	*2

\*1 C-Ring=1401C, Pin/O-Ring=1401A/B  
\*2 C-Ring=1402C, Pin/O-Ring=1402A/B

## 14400MG 6-point Sockets with Magnet Vasos Hexagonales con Imán

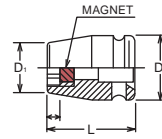

## 14401LH LHS Sockets Vasos LHS

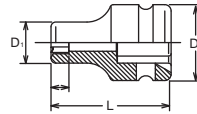

## 14410M Surface Drive Sockets Vasos Surface Drive (de Contacto Curvo)

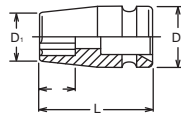

## SURFACE DRIVE

Surface drive sockets are designed to retain contact with flat sides of nut to transmit high torque and reduce nut wear. These sockets are ideal for use on polished nuts, aluminum nuts and nuts with worn out points.

Los vasos de contacto curvo se diseñan para mantener el contacto con las caras planas de la tuerca y transmitir un alto par reduciendo el desgaste de la tuerca. Estos vasos son ideales para utilizarse en tuercas pulidas, tuercas de aluminio y tuercas con puntas gastadas.

## 14465M Pathfinder Sockets Vasos Pathfinder (Guía)

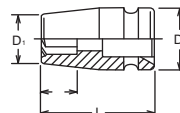

## PATHFINDER®

The beveled flats of the 6-point opening of the PATHFINDER socket engage the nut almost immediately. PATHFINDER sockets are ideal for use with power tools in automatic assembly processes, as the power tool does not have to be totally stopped for the socket to engage the nut.

Las caras biseladas de la boca hexagonal del vaso GUÍA acoplan el vaso inmediatamente.

Los vasos GUÍA son ideales para su utilización con herramientas mecánicas en procesos de montaje automático, ya que no es necesario que la herramienta esté completamente parada para acoplar el vaso a la tuerca.

HAND MANUALES  
Z-SERIES  
TITANIUM DE TITANIO  
ACCESSORIES ACCESORIOS  
SCREWDRIVERS DESTORNILLADORES  
IMPACT DE IMPACTO  
SLEEVE-DRIVE  
INDUSTRIAL INDUSTRIALES  
AUTOMOTIVE  
CONSTRUCTION CONSTRUCCION  
RENEWAL KITS JUEGOS DE PIEZAS REPUESTO

# Impact Sockets 1/2"

HAND MANUALES  
Z-SERIES  
TITANIUM DE TITANIO  
ACCESSORIES ACCESORIOS  
SCREWDRIVERS DESTORNILLADORES  
IMPACT DE IMPACTO  
SLEEVE-DRIVE  
INDUSTRIAL INDUSTRIALES  
AUTOMOTIVE  
CONSTRUCTION CONSTRUCCION  
RENEWAL KITS JUEGOS DE PIEZAS REPLÉSTO

## 14415M Double Square Sockets Vasos Octagonales

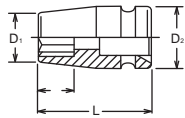

14415M (mm)	D <sub>1</sub> (mm)	D <sub>2</sub> (mm)	(mm)	L (mm)	(g)	(pcs.)	
14	25.7	30	10	38	138	10	*1
15	27	30	11	38	145	10	*1
16	29.5	30	11	38	150	10	*1
17	30.7	30	12	38	155	10	*1
18	32	30	13	38	165	10	*1
19	33.2	30	14	38	170	10	*1
22	38.2	30	14	40	185	10	*1
24	42	30	14	42	215	10	*1
27	45.7	30	16	46	278	5	*1
28	47	30	16	46	285	5	*1

\*1 C-Ring=1402C, Pin/O-Ring=1402A/B → P232-233

## 14425 TORX® Sockets Vasos TORX®

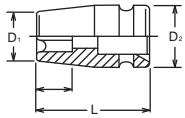

14425 (E)	D <sub>1</sub> (mm)	D <sub>2</sub> (mm)	(mm)	L (mm)	(g)	(pcs.)	
E10	14.2	25	8.2	38	86	10	*1
E11	14.7	25	8.7	38	86	10	*1
E12	15.2	25	9.3	38	85	10	*1
E14	18.2	25	10.6	38	88	10	*1
E16	19.2	25	11.8	38	88	10	*1
E18	22.2	25	13	38	89	10	*1
E20	24.2	30	14.4	38	134	10	*2
E22	26.2	30	15.5	40	140	10	*2
E24	28.2	30	17	40	138	10	*2

\*1 C-Ring=1401C, Pin/O-Ring=1401A/B  
\*2 C-Ring=1402C, Pin/O-Ring=1402A/B → P232-233

## 14425-EPL TORX PLUS® Sockets Vasos TORX PLUS®

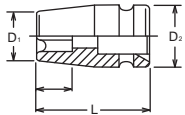

14425-EPL (EPL)	D <sub>1</sub> (mm)	D <sub>2</sub> (mm)	(mm)	L (mm)	(g)	(pcs.)	
10EPL	14.5	25	6.2	38	86	10	*1
12EPL	17	25	7.2	38	86	10	*1
14EPL	18.2	25	8.1	38	88	10	*1
16EPL	20.7	25	9.1	38	88	10	*1
18EPL	22	25	10.2	38	90	10	*1
20EPL	24.5	30	11.2	38	135	10	*2

\*1 C-Ring=1401C, Pin/O-Ring=1401A/B  
\*2 C-Ring=1402C, Pin/O-Ring=1402A/B → P232-233

## 14400-WN Weld Nut Sockets

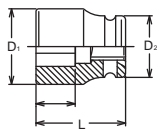

14400-WN	D <sub>1</sub> (mm)	D <sub>2</sub> (mm)	(mm)	L (mm)	(g)	(pcs.)	
8WN	18.3	25	8	38	93	10	*1
9WN	19.5	25	9	38	93	10	*1
10WN	20.8	25	10	38	92	10	*1
12WN	24.5	30	12	38	139	10	*2
14WN	27	30	14	38	136	10	*2
17WN	32	30	17	40	150	10	*2

\*1 C-Ring=1401C, Pin/O-Ring=1401A/B  
\*2 C-Ring=1402C, Pin/O-Ring=1402A/B → P232-233

## 14301X 6-point Sockets, Semi-Deep Vasos Hexagonales Medianos de pared Delgada

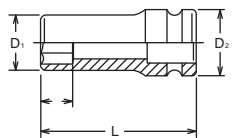

14301X (mm)	D <sub>1</sub> (mm)	D <sub>2</sub> (mm)	(mm)	L (mm)	(g)	(pcs.)	
8	13	24	8	60	72	10	*1
10	15.5	24	10	60	79	10	*1
11	16.7	24	11	60	82	10	*1
12	18	24	12	60	88	10	*1
13	19.2	24	13	60	92	10	*1
14	20.5	24	14	60	97	10	*1
15	21.7	29	15	60	125	10	*2
16	23	29	16	60	135	10	*2
17	24.2	29	17	60	142	10	*2
18	25.5	29	18	60	148	10	*2
19	26.7	29	19	60	151	10	*2
21	29.2	29	21	60	170	10	*2
22	30.5	29	22	65	187	10	*2
23	31.7	29	23	65	192	10	*2
24	33	29	24	65	202	10	*2
26	35.5	29	26	65	218	10	*2
27	36.7	29	27	65	231	10	*2

\*1 C-Ring=1401C, Pin/O-Ring=1401A/B  
\*2 C-Ring=1402C, Pin/O-Ring=1402A/B → P232-233

## RS14301X/10 Socket Set on Rail Juego de Vasos en Regleta



RS14301X/10	10 Pieces Set/Rail 300mm	(g)
10, 12, 13, 14, 17, 19, 21, 22, 24, 27		1,585

TORX® is a registered trademark of Acument Intellectual Properties, LLC.  
TORX® es una marca registrada de Acument Intellectual Properties, LLC.  
TORXplus® is a registered trademark of Acument Intellectual Properties, LLC.  
TORXplus® es una marca registrada de Acument Intellectual Properties, LLC.



14300M (mm)	D <sub>1</sub> (mm)	D <sub>2</sub> (mm)	(mm)	L (mm)	(g)	(pcs.)	⚡
8	14.5	25	8	80	137	10	*1
9	15.7	25	9	80	138	10	*1
10	17	25	10	80	140	10	*1
11	18.2	25	11	80	156	10	*1
12	19.5	25	12	80	162	10	*1
13	20.7	25	13	80	162	10	*1
14	22	25	14	80	174	10	*1
15	23.2	30	15	80	220	10	*2
16	24.5	30	16	80	232	10	*2
17	25.7	30	17	80	232	10	*2
18	27	30	18	80	232	10	*2
19	28.2	30	19	80	259	10	*2
20	29.5	30	20	80	265	10	*2
21	30.7	30	21	80	265	10	*2
22	32	30	22	85	290	10	*2
23	33.2	30	23	85	300	10	*2
24	34.5	30	24	85	329	10	*2
25	35.7	30	25	85	345	10	*2
26	37	30	26	85	350	10	*2
27	38.2	30	27	85	385	10	*2
28	39.5	30	28	85	390	10	*2
29	40.7	30	29	85	416	10	*2
30	42	30	30	85	457	10	*2
31	43.2	30	31	85	505	10	*2
32	44.5	30	32	85	542	10	*2
33	45.7	30	33	85	562	2	*2
34	47	30	33	85	570	2	*2
35	48.2	30	35	85	600	2	*2
36	49.5	30	36	85	540	2	*2
41	55.7	30	38	85	625	2	*2

\*1 C-Ring=1401C, Pin/O-Ring=1401A/B  
 \*2 C-Ring=1402C, Pin/O-Ring=1402A/B

→ P232-233

## 14300M • 14300A

6-point Deep Sockets  
Vasos Hexagonales Largos

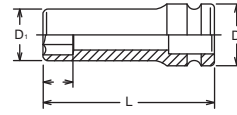

14300A (inch)	D <sub>1</sub> (mm)	D <sub>2</sub> (mm)	(mm)	L (mm)	(g)	(pcs.)	⚡
5/16	14.5	25	8	80	137	10	*1
3/8	17	25	10	80	140	10	*1
7/16	18.2	25	11	80	156	10	*1
1/2	20.7	25	13	80	162	10	*1
9/16	22	25	14	80	174	10	*1
5/8	24.5	30	16	80	232	10	*2
11/16	25.7	30	17	80	232	10	*2
3/4	28.2	30	19	80	259	10	*2
13/16	30.7	30	21	80	265	10	*2
7/8	32	30	22	85	290	10	*2
15/16	34.5	30	24	85	329	10	*2
1	35.7	30	25	85	345	10	*2
1. 1/16	38.2	30	27	85	385	10	*2
1. 1/8	40.7	30	29	85	416	10	*2
1. 3/16	42	30	30	85	457	10	*2
1. 1/4	44.5	30	32	85	542	10	*2
1. 7/16	50.7	30	37	85	570	2	*2
1. 1/2	52	30	38	85	580	2	*2

\*1 C-Ring=1401C, Pin/O-Ring=1401A/B  
 \*2 C-Ring=1402C, Pin/O-Ring=1402A/B

→ P232-233

14301M (mm)	D <sub>1</sub> (mm)	D <sub>2</sub> (mm)	(mm)	L (mm)	(g)	(pcs.)	⚡
8	13	24	8	80	87	10	*1
9	14.2	24	9	80	92	10	*1
10	15.5	24	10	80	98	10	*1
11	16.7	24	11	80	104	10	*1
12	18	24	12	80	111	10	*1
13	19.2	24	13	80	120	10	*1
14	20.5	24	14	80	127	10	*1
15	21.7	29	15	80	169	10	*2
16	23	29	16	80	173	10	*2
17	24.2	29	17	80	182	10	*2
18	25.5	29	18	80	192	10	*2
19	26.7	29	19	80	197	10	*2
20	28	29	20	80	203	10	*2
21	29.2	29	21	80	218	10	*2
22	30.5	29	22	85	244	10	*2
23	31.7	29	23	85	253	10	*2
24	33	29	24	85	261	10	*2
25	34.2	29	25	85	282	10	*2
26	35.5	29	26	85	299	10	*2
27	36.7	29	27	85	314	10	*2
28	38	29	29	85	273	10	*2
29	39.2	29	29	85	280	10	*2
30	40.5	29	30	85	360	10	*2
31	41.7	29	31	85	370	10	*2
32	43	29	32	85	380	10	*2
34	45.5	29	34	85	411	2	*2
35	46.7	29	35	85	450	2	*2
36	48	29	36	85	460	2	*2

\*1 C-Ring=1401C, Pin/O-Ring=1401A/B  
 \*2 C-Ring=1402C, Pin/O-Ring=1402A/B

→ P232-233



## 14301M • 14301A

6-point Deep Sockets, Thin-walled  
Vasos Hexagonales Largos de Pared Delgada

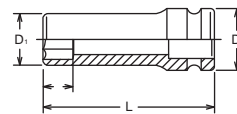

14301A (inch)	D <sub>1</sub> (mm)	D <sub>2</sub> (mm)	(mm)	L (mm)	(g)	(pcs.)	⚡
3/8	15.5	24	10	80	98	10	*1
7/16	16.7	24	11	80	104	10	*1
1/2	19.2	24	13	80	120	10	*1
9/16	20.5	24	14	80	127	10	*1
5/8	23	29	16	80	173	10	*2
11/16	24.2	29	17	80	182	10	*2
3/4	26.7	29	19	80	197	10	*2
13/16	29.2	29	21	80	218	10	*2
7/8	30.5	29	22	85	244	10	*2
15/16	33	29	24	85	261	10	*2
1. 1/16	36.7	29	27	85	314	10	*2

\*1 C-Ring=1401C, Pin/O-Ring=1401A/B  
 \*2 C-Ring=1402C, Pin/O-Ring=1402A/B

→ P232-233

HAND MANUALES  
 Z-SERIES  
 TITANIUM DE TITANIO  
 ACCESSORIES ACCESORIOS  
 SCREWDRIVERS DESTORNILLADORES  
 IMPACT DE IMPACTO  
 SLEEVE-DRIVE INDUSTRIAL INDUSTRIALES  
 AUTOMOTIVE  
 CONSTRUCTION CONSTRUCCION  
 RENEWAL KITS JUEGOS DE PIEZAS REPUESTO

# Impact Sockets **1/2"**

HAND MANUALES  
Z-SERIES  
TITANIUM DE TITANIO  
ACCESSORIES ACCESORIOS  
SCREWDRIVERS DESTORNILLADORES  
IMPACT DE IMPACTO  
SLEEVE-DRIVE  
INDUSTRIAL INDUSTRIALES  
AUTOMOTIVE  
CONSTRUCTION CONSTRUCCIÓN  
RENEWAL KITS JUEGOS DE PIEZAS REPLÉSTO

## 14305M 12-point Deep Sockets Vasos Bihexagonales Largos

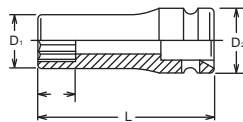

14305M (mm)	D <sub>1</sub> (mm)	D <sub>2</sub> (mm)	(mm)	L (mm)	(g)	(pcs.)	(V)
8	14.5	25	8	80	137	10	*1
10	17	25	10	80	140	10	*1
11	18.2	25	11	80	156	10	*1
12	19.5	25	12	80	162	10	*1
13	20.7	25	13	80	162	10	*1
14	22	25	14	80	174	10	*1
15	23.2	30	15	80	220	10	*2
16	24.5	30	16	80	232	10	*2
17	25.7	30	17	80	232	10	*2
18	27	30	18	80	232	10	*2
19	28.2	30	19	80	259	10	*2
20	29.5	30	20	80	265	10	*2
21	30.7	30	21	80	265	10	*2
22	32	30	22	85	290	10	*2
24	34.5	30	24	85	329	10	*2
27	38.2	30	27	85	385	10	*2
28	39.5	30	30	85	390	10	*2
30	42	30	30	85	457	10	*2
32	44.5	30	32	85	542	10	*2
36	49.5	30	36	85	635	2	*2

\*1 C-Ring=1401C, Pin/O-Ring=1401A/B → P232-233  
\*2 C-Ring=1402C, Pin/O-Ring=1402A/B

## 14306M 12-point Deep Sockets, Thin-Walled Vasos Bihexagonales Largos de Pared Delgada

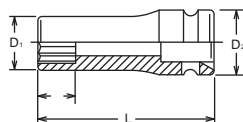

14306M (mm)	D <sub>1</sub> (mm)	D <sub>2</sub> (mm)	(mm)	L (mm)	(g)	(pcs.)	(V)
10	15.5	24	10	80	98	10	*1
12	18	24	12	80	111	10	*1
13	19.2	24	13	80	120	10	*1
14	20.5	24	14	80	127	10	*1
15	21.7	29	15	80	169	10	*2
16	23	29	16	80	173	10	*2
17	24.2	29	17	80	182	10	*2
18	25.5	29	18	80	192	10	*2
19	26.7	29	19	80	197	10	*2
21	29.2	29	21	80	218	10	*2
22	30.5	29	22	85	244	10	*2
24	33	29	24	85	261	10	*2
27	36.7	29	27	85	314	10	*2
30	40.5	29	30	85	360	10	*2
32	43	29	32	85	380	10	*2

\*1 C-Ring=1401C, Pin/O-Ring=1401A/B → P232-233  
\*2 C-Ring=1402C, Pin/O-Ring=1402A/B

## 14310M Surface Drive Sockets, deep Vasos Surface Drive (de Contacto Curvo) Largos

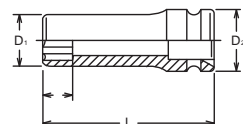

14310M (mm)	D <sub>1</sub> (mm)	D <sub>2</sub> (mm)	(mm)	L (mm)	(g)	(pcs.)	(V)
10	17	25	10	80	136	10	*1
11	18.2	25	11	80	148	10	*1
12	19.5	25	12	80	156	10	*1
13	20.7	25	13	80	158	10	*1
14	22	25	14	80	170	10	*1
15	23.2	30	15	80	225	10	*2
16	24.5	30	16	80	228	10	*2
17	25.7	30	17	80	232	10	*2
18	27	30	18	80	232	10	*2
19	28.2	30	19	80	252	10	*2
20	29.5	30	20	80	260	10	*2
21	30.7	30	21	80	260	10	*2
22	32	30	22	85	290	10	*2
24	34.5	30	24	85	322	10	*2
25	35.7	30	25	85	338	10	*2
26	37	30	26	85	350	10	*2
27	38.2	30	27	85	380	10	*2
30	42	30	30	85	450	10	*2
32	44.5	30	32	85	535	10	*2
34	47	30	34	85	563	2	*2
36	49.5	30	36	85	630	2	*2

\*1 C-Ring=1401C, Pin/O-Ring=1401A/B → P232-233  
\*2 C-Ring=1402C, Pin/O-Ring=1402A/B

## SURFACE DRIVE

Surface drive sockets are designed to retain contact with flat sides of nut to transmit high torque and reduce nut wear. These sockets are ideal for use on polished nuts, aluminum nuts and nuts with worn out points.

Los vasos de contacto curvo se diseñan para mantener el contacto con las caras planas de la tuerca y transmitir un alto par reduciendo el desgaste de la tuerca. Estos vasos son ideales para utilizarse en tuercas pulidas, tuercas de aluminio y tuercas con puntas gastadas

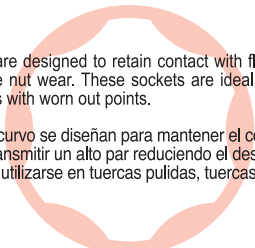

# 1/2" Impact Sockets

HAND MANUALES  
Z-SERIES  
TITANIUM DE TITANIO  
ACCESSORIES ACCESORIOS  
SCREWDRIVERS DESTORNILLADORES  
IMPACT DE IMPACTO  
SLEEVE-DRIVE INDUSTRIAL INDUSTRIALES  
AUTOMOTIVE  
CONSTRUCTION CONSTRUCCION  
RENEWAL KITS JUEGOS DE PIEZAS REPUESTO

14300G (mm)	D <sub>1</sub> (mm)	D <sub>2</sub> (mm)	(mm)	L (mm)t	(g)	(pcs.)	⚡
10	17	25	4.5	80	139	10	*1
12	19.5	25	6	80	165	10	*1
13	20.7	25	6.5	80	185	10	*1
14	22	25	7	80	189	10	*1
New 16	24.5	30	7.5	80	270	10	*2
17	25.7	30	8	80	272	10	*2
New 18	27	30	8.5	80	290	10	*2
19	28.2	30	9	80	308	10	*2

\*1 C-Ring=1401C, Pin/O-Ring=1401A/B → P232-233  
\*2 C-Ring=1402C, Pin/O-Ring=1402A/B

## 14300G Impact Socket with Sliding Magnet Vasos de Impacto con Imán Corredizo

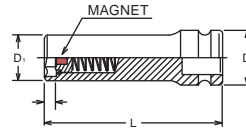

14365M (mm)	D <sub>1</sub> (mm)	D <sub>2</sub> (mm)	(mm)	L (mm)	(g)	(pcs.)	⚡
10	17	25	8	80	138	10	*1
11	18.2	25	8	80	144	10	*1
12	19.5	25	9	80	165	10	*1
13	20.7	25	9	80	170	10	*1
14	22	25	11	80	178	10	*1
15	23.2	30	11	80	237	10	*2
16	24.5	30	11	80	245	10	*2
17	25.7	30	12	80	263	10	*2
18	27	30	13	80	268	10	*2
19	28.2	30	13	80	270	10	*2
20	29.5	30	14	80	274	10	*2
21	30.7	30	14	80	287	10	*2
22	32	30	15	85	314	10	*2
23	33.2	30	15	85	320	10	*2
24	34.5	30	15	85	335	10	*2
26	37	30	15	85	388	10	*2
27	38.2	30	16	85	407	10	*2

\*1 C-Ring=1401C, Pin/O-Ring=1401A/B → P232-233  
\*2 C-Ring=1402C, Pin/O-Ring=1402A/B

## 14365M Pathfinder Sockets, deep Vasos Pathfinder (Guía) Largos

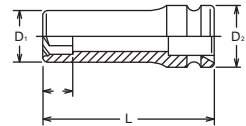

14325 (E)	D <sub>1</sub> (mm)	D <sub>2</sub> (mm)	(mm)	L (mm)	(g)	(pcs.)	⚡
E10	14.2	25	8.2	80	136	10	*1
E12	15.2	25	9.3	80	141	10	*1
E14	18.2	25	10.6	80	147	10	*1
E16	19.2	25	11.8	80	151	10	*1
E18	22.2	25	13	80	218	10	*1
E20	24.2	30	14.4	80	225	10	*2

\*1 C-Ring=1401C, Pin/O-Ring=1401A/B → P232-233  
\*2 C-Ring=1402C, Pin/O-Ring=1402A/B

## 14325 TORX® Deep Sockets Vasos TORX® Largos

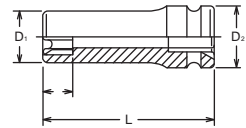

14440M (mm)	D (mm)	(mm)	L (mm)	(g)	(pcs.)	⚡
13	20.7	6	67.5	210	10	*1
14	22	7	69.5	210	10	*1
15	23.2	7	69.5	210	10	*1
16	24.5	8	69.5	206	10	*1
17	25.7	8	69.5	220	10	*1
18	27	9	69.5	218	10	*1
19	28.2	10	73.5	260	10	*1
20	29.5	10	73.5	270	10	*1
21	30.7	11	73.5	280	10	*1
22	32	13	73.5	290	10	*1
24	34.5	14	73.5	300	10	*1

14440A (inch)	D (mm)	(mm)	L (mm)	(g)	(pcs.)	⚡
1/2	20.7	6	67.5	210	10	*1
9/16	22	7	69.5	210	10	*1
5/8	24.5	8	69.5	206	10	*1
11/16	25.7	8	69.5	220	10	*1
3/4	28.2	10	73.5	260	10	*1

\*1 C-Ring=1402C, Pin/O-Ring=1402A/B → P232-233

## 14440M • 14440A Universal Sockets Vasos con Articulación Universal

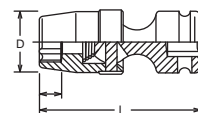

# Impact Sockets 1/2"

HAND MANUALES  
Z-SERIES  
TITANIUM DE TITANIO  
ACCESSORIES ACCESORIOS  
SCREWDRIVERS DESTORNILLADORES  
IMPACT DE IMPACTO  
SLEEVE-DRIVE  
INDUSTRIAL INDUSTRIALES  
AUTOMOTIVE  
CONSTRUCTION CONSTRUCCION  
RENEWAL KITS JUEGOS DE PIEZAS REPLUESTO

## 14012M-60 Inhex Sockets Vasos Inhex



14012M.60 (mm)	D (mm)	(mm)	L (mm)	(g)	(pcs.)	
4	25	15.5	60	68	10	*1
5	25	15.5	60	71	10	*1
6	25	15.5	60	74	10	*1
7	25	15.5	60	80	10	*1
8	25	15.5	60	84	10	*1
10	30	15.5	60	140	10	*2
12	30	15.5	60	150	10	*2
14	30	15.5	60	170	10	*2
17	30	15.5	60	190	10	*2
19	30	15.5	60	210	10	*2

\*1 C-Ring=1401C, Pin/O-Ring=1401A/B → P232-233  
\*2 C-Ring=1402C, Pin/O-Ring=1402A/B

## RS14012M/10-L60 Socket Set on Rail Juego de Vasos en Regleta



RS14012M/10-L60	10 Pieces Set/Rail 300mm	 (g)
4, 5, 6, 7, 8, 10, 12, 14, 17, 19		1,300

## 14025-60 TORX® Bit Sockets Vasos con Punta TORX®



14025.60 (mm)	D (mm)	L (mm)	(g)	(pcs.)	
New T20	25	60	75	10	*1
New T25	25	60	75	10	*1
New T27	25	60	75	10	*1
T30	25	60	80	10	*1
T40	25	60	85	10	*1
T45	25	60	85	10	*1
T50	25	60	95	10	*1
T55	25	60	110	10	*1
T60	30	60	160	10	*2

\*1 C-Ring=1401C, Pin/O-Ring=1401A/B → P232-233  
\*2 C-Ring=1402C, Pin/O-Ring=1402A/B

## RS14025/6-L60 Socket Set on Rail Juego de Vasos en Regleta





RS14025/6-L60	6 Pieces Set/Rail 200mm	 (g)
T30, T40, T45, T50, T55, T60		650

## 14105 Bit Holder Porta Punta



	D <sub>1</sub> (mm)	D <sub>2</sub> (mm)	L (mm)	(g)	(pcs.)	
14105	22	30	38	126	10	*1

\*1 C-Ring=1402C, Pin/O-Ring=1402A/B → P232-233

 Replacement Screw : M5x6,  2.5mm

## 14105L Bit Holder Porta Punta



	D <sub>1</sub> (mm)	D <sub>2</sub> (mm)	L (mm)	(g)	(pcs.)	
14105L	22	30	43	160	10	*1

\*1 C-Ring=1402C, Pin/O-Ring=1402A/B → P232-233



107.11 (mm)	L (mm)	(g)	(pcs.)
3	35	15	10
4	35	16	10
5	35	16	10
6	35	18	10
7	35	19	10
8	35	20	10
10	35	26	10
11	35	28	10
12	35	31	10
14	35	38	10
16	35	47	10
17	35	50	10
18	35	53	10
19	35	56	10

107.11(L80) (mm)	L (mm)	(g)	(pcs.)
4	80	54	10
5	80	54	10
6	80	56	10
7	80	57	10
8	80	59	10
10	80	64	10
11	80	66	10
12	80	76	10
14	80	98	10

107.11 (T)	L (mm)	(g)	(pcs.)
T25	35	18	10
T30	35	18	10
T40	35	20	10
T45	35	22	10
T50	35	26	10
T55	35	31	10
T60	35	38	10

107.11(L80) (T)	L (mm)	(g)	(pcs.)
T30	80	54	10
T40	80	54	10
T45	80	56	10
T50	80	57	10
T55	80	66	10
T60	80	76	10

107.11 (XZN)	L (mm)	(g)	(pcs.)
M 4	35	18	10
M 5	35	20	10
M 6	35	22	10
M 8	35	26	10
M10	35	31	10
M12	35	38	10

107.11(L80) (XZN)	L (mm)	(g)	(pcs.)
M 4	80	54	10
M 5	80	54	10
M 6	80	56	10
M 8	80	57	10
M10	80	66	10
M12	80	76	10
M14	80	80	10

## 107-11 Bits for Inhex Screws Puntas para Tornillos Inhex

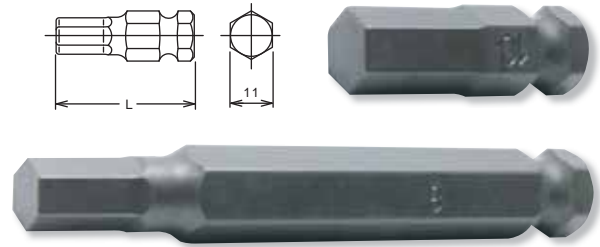

107.11 (inch)	L (mm)	(g)	(pcs.)
3/16	35	15	10
7/32	35	16	10
1/4	35	18	10
5/16	35	20	10
3/8	35	26	10
7/16	35	28	10
1/2	35	38	10
5/8	35	47	10
3/4	35	56	10

## 107-11 (T) TORX® Bits Puntas TORX®

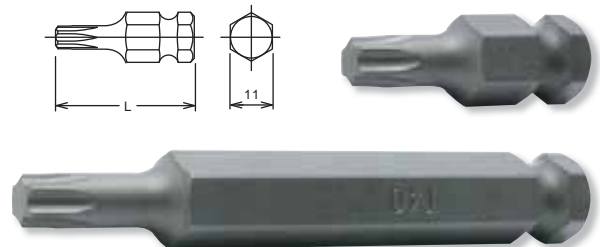

## 107-11 (XZN) XZN Bits Puntas XZN

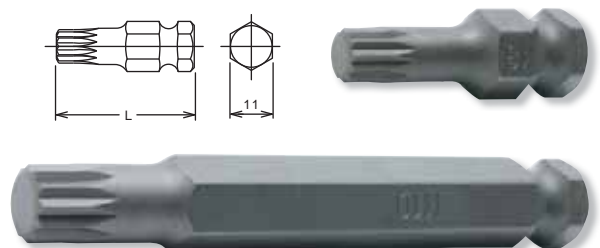

HAND MANUALES  
Z-SERIES  
TITANIUM DE TITANIO  
ACCESSORIES ACCESORIOS  
SCREWDRIVERS DESTORNILLADORES  
IMPACT DE IMPACTO  
SLEEVE-DRIVE INDUSTRIAL INDUSTRIALES  
AUTOMOTIVE  
CONSTRUCTION CONSTRUCCION  
RENEWAL KITS JUEGOS DE PIEZAS REPUESTO



HAND MANUALES  
Z-SERIES  
TITANIUM DE TITANIO  
ACCESSORIES ACCESORIOS  
SCREWDRIVERS DESTORNILLADORES  
IMPACT DE IMPACTO  
SLEEVE-DRIVE  
INDUSTRIAL INDUSTRIALES  
AUTOMOTIVE  
CONSTRUCTION CONSTRUCCIÓN  
RENEWAL KITS JUEGOS DE PIEZAS REPLÉSTO

## 14105-11 Hex bit sockets Vasos con Punta Hexagonal



14105.11 (mm)	L (mm)	(g)	(pcs.)	
3	60	141	10	*1
4	60	142	10	*1
5	60	142	10	*1
6	60	144	10	*1
7	60	145	10	*1
8	60	146	10	*1
10	60	152	10	*1
11	60	154	10	*1
12	60	157	10	*1
14	60	164	10	*1
16	60	173	10	*1
17	60	176	10	*1
18	60	179	10	*1
19	60	182	10	*1

14105.11 (inch)	L (mm)	(g)	(pcs.)	
1/4	60	144	10	*1
5/16	60	146	10	*1
3/8	60	152	10	*1
1/2	60	164	10	*1
3/4	60	182	10	*1

\*1 C-Ring=1402C, Pin/O-Ring=1402A/B → P232-233

## 14105-11 (T) TORX® Bit Sockets Vasos con Punta TORX®



14105.11 (T)	L (mm)	(g)	(pcs.)	
T25	60	144	10	*1
T30	60	144	10	*1
T40	60	146	10	*1
T45	60	152	10	*1
T50	60	157	10	*1
T55	60	160	10	*1
T60	60	164	10	*1

\*1 C-Ring=1402C, Pin/O-Ring=1402A/B → P232-233

## 14105-11 (XZN) XZN Bit Sockets Vasos con Punta XZN



14105.11 (XZN)	L (mm)	(g)	(pcs.)	
M 4	60	144	10	*1
M 5	60	146	10	*1
M 6	60	152	10	*1
M 8	60	157	10	*1
M10	60	160	10	*1
M12	60	164	10	*1

\*1 C-Ring=1402C, Pin/O-Ring=1402A/B → P232-233

## 14105-L105 Hex Bit Sockets Vasos con Punta Hexagonal



14105(L105) (mm)	L (mm)	(g)	(pcs.)	
4	105	180	10	*1
5	105	180	10	*1
6	105	185	10	*1
7	105	185	10	*1
8	105	185	10	*1
10	105	190	10	*1
11	105	190	10	*1
12	105	200	10	*1
14	105	230	10	*1

\*1 C-Ring=1402C, Pin/O-Ring=1402A/B → P232-233

## 14105-L105 (T) TORX® Bit Sockets Vasos con Punta TORX®



14105(L105) (T)	L (mm)	(g)	(pcs.)	
T30	105	180	10	*1
T40	105	180	10	*1
T45	105	185	10	*1
T50	105	185	10	*1
T55	105	195	10	*1
T60	105	205	10	*1

\*1 C-Ring=1402C, Pin/O-Ring=1402A/B → P232-233

	D <sub>1</sub> (mm)	D <sub>2</sub> (mm)	L (mm)	(g)	(pcs.)	
<b>14106</b>	28	30	43	160	10	*1

\*1 C-Ring=1402C, Pin/O-Ring=1402A/B → P232-233

Replacement Screw : M6x8, 3mm



## 14106 Bit Holder for 107-16 Porta Punta

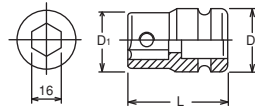

107.16 (mm)	L (mm)	(g)	(pcs.)
10	40	46	10
12	40	52	10
13	40	56	10
14	40	60	10
16	40	69	10
17	40	73	10
18	40	78	10
19	40	80	10
22	40	97	10

107.16 (inch)	L (mm)	(g)	(pcs.)
1/2	40	56	10
9/16	40	60	10
5/8	40	69	10
3/4	40	80	10

107.16 (T)	L (mm)	(g)	(pcs.)
T55	50	57	10
T60	50	64	10
T70	50	73	10

107.16 (XZN)	L (mm)	(g)	(pcs.)
M14	60	83	10
M16	60	93	10
M18	60	103	10

## 107-16 Bits for Inhex screws Puntas para Tornillos Inhex

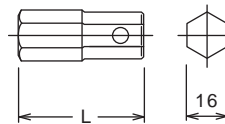

## 107-16 (T) TORX® Bits Puntas TORX®

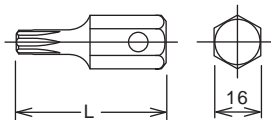

## 107-16 (XZN) XZN Bits Puntas XZN

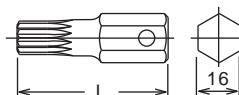

HAND MANUALES  
Z-SERIES  
TITANIUM DE TITANIO  
ACCESSORIES ACCESORIOS  
SCREWDRIVERS DESTORNILLADORES  
IMPACT DE IMPACTO  
SLEEVE-DRIVE INDUSTRIAL INDUSTRIALES  
AUTOMOTIVE  
CONSTRUCTION CONSTRUCCION  
RENEWAL KITS JUEGOS DE PIEZAS REPIESTO

# Impact Sockets 1/2"

HAND MANUALES  
Z-SERIES  
TITANIUM DE TITANIO  
ACCESSORIES ACCESORIOS  
SCREWDRIVERS DESTORNILLADORES  
IMPACT DE IMPACTO  
SLEEVE-DRIVE  
INDUSTRIAL INDUSTRIALES  
AUTOMOTIVE  
CONSTRUCTION CONSTRUCCIÓN  
RENEWAL KITS JUEGOS DE PIEZAS REPLÉSTO

## 14145M-150 · -200 · -250 Extra Long Sockets Vasos Extra-Largos

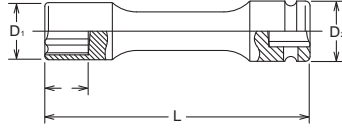

14145M.200 (mm)	D <sub>1</sub> (mm)	D <sub>2</sub> (mm)	(mm)	L (mm)	(g)	(pce.)	
10	17	25	10	200	234	1	*1
12	19.5	25	12	200	248	1	*1
13	20.7	25	13	200	260	1	*1
14	22	25	14	200	272	1	*1
15	23.2	25	15	200	284	1	*1
16	24.5	25	16	200	290	1	*1
17	25.7	25	17	200	297	1	*1
18	27	25	18	200	305	1	*1
19	28.2	25	19	200	311	1	*1

\*1 C-Ring=1401C, Pin/O-Ring=1401A/B → P232-233

14145M.150 (mm)	D <sub>1</sub> (mm)	D <sub>2</sub> (mm)	(mm)	L (mm)	(g)	(pce.)	
10	17	25	10	150	190	1	*1
12	19.5	25	12	150	204	1	*1
13	20.7	25	13	150	216	1	*1
14	22	25	14	150	228	1	*1
15	23.2	25	15	150	240	1	*1
16	24.5	25	16	150	245	1	*1
17	25.7	25	17	150	253	1	*1
18	27	25	18	150	260	1	*1
19	28.2	25	19	150	267	1	*1

14145M.250 (mm)	D <sub>1</sub> (mm)	D <sub>2</sub> (mm)	(mm)	L (mm)	(g)	(pce.)	
10	17	25	10	250	278	1	*1
12	19.5	25	12	250	292	1	*1
13	20.7	25	13	250	304	1	*1
14	22	25	14	250	316	1	*1
15	23.2	25	15	250	328	1	*1
16	24.5	25	16	250	335	1	*1
17	25.7	25	17	250	341	1	*1
18	27	25	18	250	350	1	*1
19	28.2	25	19	250	355	1	*1

\*1 C-Ring=1401C, Pin/O-Ring=1401A/B → P232-233

## 14146M-150 · -200 · -250 Extra Long Universal Sockets Vasos con Articulación Universal Extra-Largos

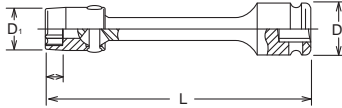

14146M.200 (mm)	D <sub>1</sub> (mm)	D <sub>2</sub> (mm)	(mm)	L (mm)	(g)	(pce.)	
10	16	25	6.5	200	241	1	*1
12	19.3	25	7.5	200	244	1	*1
13	20	25	8	200	245	1	*1
14	21	25	8.5	200	247	1	*1
15	22	25	9	200	245	1	*1
16	23	25	9.5	200	244	1	*1
17	25	25	9.5	200	244	1	*1
18	26	25	11	200	250	1	*1
19	28	25	11.5	200	254	1	*1

\*1 C-Ring=1401C, Pin/O-Ring=1401A/B → P232-233

14146M.150 (mm)	D <sub>1</sub> (mm)	D <sub>2</sub> (mm)	(mm)	L (mm)	(g)	(pce.)	
10	16	25	6.5	150	197	1	*1
12	19.3	25	7.5	150	200	1	*1
13	20	25	8	150	201	1	*1
14	21	25	8.5	150	203	1	*1
15	22	25	9	150	201	1	*1
16	23	25	9.5	150	200	1	*1
17	25	25	9.5	150	200	1	*1
18	26	25	11	150	210	1	*1
19	28	25	11.5	150	210	1	*1

14146M.250 (mm)	D <sub>1</sub> (mm)	D <sub>2</sub> (mm)	(mm)	L (mm)	(g)	(pce.)	
10	16	25	6.5	250	285	1	*1
12	19.3	25	7.5	250	288	1	*1
13	20	25	8	250	289	1	*1
14	21	25	8.5	250	291	1	*1
15	22	25	9	250	289	1	*1
16	23	25	9.5	250	288	1	*1
17	25	25	9.5	250	288	1	*1
18	26	25	11	250	290	1	*1
19	28	25	11.5	250	299	1	*1

\*1 C-Ring=1401C, Pin/O-Ring=1401A/B → P232-233

## 14147M-150 · -200 Extra Long Universal Inhex Sockets Vasos Inhex con Articulación Universal Extra-Largos

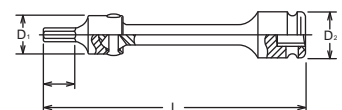

14147M.150 (mm)	D <sub>1</sub> (mm)	D <sub>2</sub> (mm)	(mm)	L (mm)	(g)	(pce.)	
6	25	25	15	150	200	1	*1
8	25	25	15	150	205	1	*1
10	25	25	15	150	210	1	*1
12	25	25	15	150	217	1	*1

14147M.200 (mm)	D <sub>1</sub> (mm)	D <sub>2</sub> (mm)	(mm)	L (mm)	(g)	(pce.)	
6	25	25	15	200	244	1	*1
8	25	25	15	200	249	1	*1
10	25	25	15	200	254	1	*1
12	25	25	15	200	261	1	*1

\*1 C-Ring=1401C, Pin/O-Ring=1401A/B → P232-233

14760	D (mm)	L (mm)	(g)	(pce.)	⚡
50	30	50	150	1	*1
75	30	75	188	1	*1
100	30	100	240	1	*1
125	30	125	275	1	*1
150	30	150	300	1	*1
175	30	175	358	1	*1
200	30	200	405	1	*1
250	30	250	480	1	*1

\*1 C-Ring=1402C, Pin/O-Ring=1402A/B → P232-233

### Lock & Quick Release

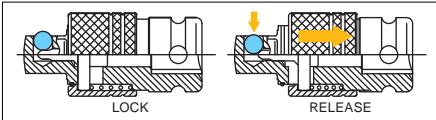

14444AL	L (mm)	(g)	(pcs.)	⚡
14444AL	55	128	5	*1

\*1 C-Ring=1401C, Pin/O-Ring=1401A/B → P232-233

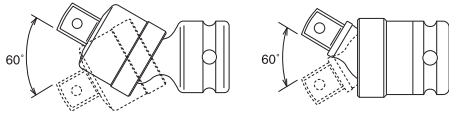

	L (mm)	(g)	(pcs.)	⚡
14770	74	210	5	*1
14770-B	74	210	5	*1
14770-P	74	210	5	*1
14771	65	198	5	*1
14771-B	65	198	5	*1
14771-P	65	198	5	*1

\*1 C-Ring=1402C, Pin/O-Ring=1402A/B → P232-233

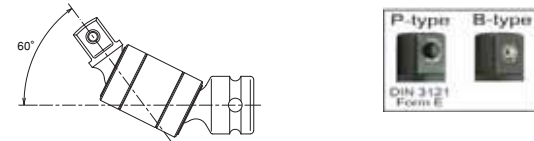

14772-P	D1 (mm)	D2 (mm)	L (mm)	(g)	(pcs.)	⚡
14772-P	27	25	90	230	5	*1

\*1 C-Ring=1401C, Pin/O-Ring=1401A/B → P232-233



## 14760-50 · -75 · -100 · -125 · -150 · -175 · -200 · -250

Extension Bars  
Alargaderas

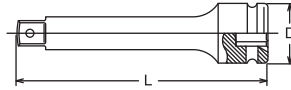

## 14444AL

Adaptor (Quick Release)  
Adaptador (Extracción Rápida)

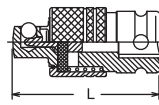

## 14770

Universal Joint  
Articulación Universal

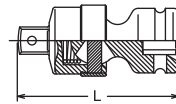

## 14771

Universal Joint  
Articulación Universal

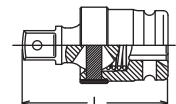

## 14772-P

Universal Double Joint  
Articulación Universal

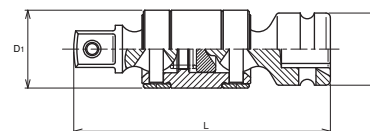

HAND MANUALES  
Z-SERIES  
TITANIUM DE TITANIO  
ACCESSORIES ACCESORIOS  
SCREWDRIVERS DESTORNILLADORES  
IMPACT DE IMPACTO  
SLEEVE-DRIVE INDUSTRIAL INDUSTRIALES  
AUTOMOTIVE  
CONSTRUCTION CONSTRUCCION  
RENEWAL KITS JUEGOS DE PIEZAS REPUESTO

# Impact Sockets 1/2"

HAND MANUALES  
Z-SERIES  
TITANIUM DE TITANIO  
ACCESSORIES ACCESORIOS  
SCREWDRIVERS DESTORNILLADORES  
IMPACT DE IMPACTO  
SLEEVE-DRIVE  
INDUSTRIAL INDUSTRIALES  
AUTOMOTIVE  
CONSTRUCTION CONSTRUCCION  
RENEWAL KITS JUEGOS DE PIEZAS REPLÉSTO

## 14433A Adaptor Adaptador ⚠

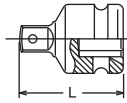

## 14455A Adaptor Adaptador

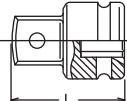

## 14466A Adaptor Adaptador

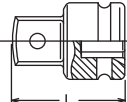

## 14203M Set Juego



## 14204M Set Juego



## 14204T Set Juego



## 14204X Set Juego



	□ (sq.)	□ (sq.)	L (mm)	⚖ (g)	📦 (pcs.)	⚡
14433A	1/2"	3/8"	36	68	10	*1
14433A-B	1/2"	3/8"	36	68	10	*1
14433A-P	1/2"	3/8"	36	68	10	*1

\*1 C-Ring=1401C, Pin/O-Ring=1401A/B → P232-233

⚠ Adapting down to a smaller square drive may lead to excessive torque load and possibly cause breakage. Always stay within limit torque of the smaller square drive.



	□ (sq.)	□ (sq.)	L (mm)	⚖ (g)	📦 (pcs.)	⚡
14455A	1/2"	5/8"	42	135	10	*1

\*1 C-Ring=1402C, Pin/O-Ring=1402A/B → P232-233

	□ (sq.)	□ (sq.)	L (mm)	⚖ (g)	📦 (pcs.)	⚡
14466A	1/2"	3/4"	44	146	10	*1
14466A-B	1/2"	3/4"	44	146	10	*1

\*1 C-Ring=1402C, Pin/O-Ring=1402A/B → P232-233

14203M		10 Pieces Set/⚖=900g
METAL CASE: W215xH80xT47mm		
Bits		Bit Holder
107.11 Hex Bits 5, 6, 8, 10		14105 Bit Holder
107.16 Hex Bits 12, 14, 17, 19		14106 Bit Holder

14204M		18 Pieces Set/⚖=1,370g
METAL CASE: W310xH90xT48mm		
Bits		Bit Holder
107.11 Hex Bits 4, 5, 6, 7, 8, 10, 12, 14		14105 Bit Holder
107.11(L80) Hex Bits 4, 5, 6, 7, 8, 10, 12, 14		168H-2.5(40) Screwdriver

14204T		14 Pieces Set/⚖=1,180g
METAL CASE: W310xH90xT48mm		
Bits		Bit Holder
107.11(T) TORX® Bits T30, T40, T45, T50, T55, T60		14105 Bit Holder
107.11(T)(L80) TORX® Bits T30, T40, T45, T50, T55, T60		168H-2.5(40) Screwdriver

14204X		14 Pieces Set/⚖=1,180g
METAL CASE: W310xH90xT48mm		
Bits		Bit Holder
107.11(XZN) XZN Bits M4, M5, M6, M8, M10, M12		14105 Bit Holder
107.11(L80) XZN Bits M4, M5, M6, M8, M10, M12		168H-2.5(40) Screwdriver





# 1/2" Impact Sockets

HAND  
MANUALES  
Z-SERIES  
TITANIUM  
DE TITANIO  
ACCESSORIES  
ACCESORIOS  
SCREWDRIVERS  
DESTORNILLADORES  
IMPACT  
DE IMPACTO  
SLEEVE-DRIVE  
INDUSTRIAL  
INDUSTRIALES  
AUTOMOTIVE  
CONSTRUCTION  
CONSTRUCCION  
RENEWAL KITS  
JUEGOS DE PIEZAS REPUESTO





<b>14207M</b>	10 Pieces Set/△=2,700g
METAL CASE:W310xH90xT48mm	
Sockets	
 <b>14300M</b> 6-pt Deep Sockets	10, 12, 13, 14, 17, 19, 21, 22, 24, 27





<b>14208M</b>	13 Pieces Set/△=3,500g
METAL CASE:W395xH90xT50mm	
Sockets	
 <b>14300M</b> 6-pt Deep Sockets	10, 12, 13, 14, 15, 16, 17, 18, 19, 21, 22, 24, 27

<b>14241M</b>	13 Pieces Set/△=2,000g
METAL CASE:W196xH100xT45mm	
Sockets	
 <b>14400M</b> 6-pt. Sockets	10, 11, 12, 13, 14, 15, 16, 17, 19, 21, 22, 24, 27

<b>14241M-05</b>	13 Pieces Set/△=2,000g
METAL CASE:W196xH100xT45mm	
Sockets	
 <b>14405M</b> 12-pt. Sockets	10, 11, 12, 13, 14, 15, 16, 17, 19, 21, 22, 24, 27

<b>14242M</b>	12 Pieces Set/△=1,890g
METAL CASE:W310xH90xT48mm	
Sockets	
 <b>14400M</b> 6-pt. Sockets	10, 11, 12, 13, 14, 15, 16, 17, 19, 21, 22, 27

<b>14245M-00</b>	18 Pieces Set/△=2,250g
METAL CASE:W310xH90xT45mm	
Sockets	Accessories
 <b>14400M</b> 6-pt.Sockets	 <b>14760-125</b>
10, 12, 13, 14, 16, 17, 18, 19, 21, 22, 24, 27	<b>14770</b>
	 <b>1401A, 1402A</b>
	 <b>1401B, 1402B</b>

<b>14245M-05</b>	18 Pieces Set/△=2,250g
METAL CASE:W310xH90xT48mm	
Sockets	Accessories
 <b>14405M</b> 12-pt. Sockets	 <b>14760-125</b>
10, 12, 13, 14, 16, 17, 18, 19, 21, 22, 24, 27	<b>14770</b>
	 <b>1401A, 1402A</b>
	 <b>1401B, 1402B</b>

<b>S14240M</b>	14400M 98 Pieces Set/△=13,690g	
DISPLAY STAND:W510xH150xT230mm		
 10mm:8pcs	15mm:7pcs	22mm:6pcs
11mm:8pcs	16mm:7pcs	23mm:6pcs
12mm:8pcs	17mm:7pcs	24mm:6pcs
13mm:8pcs	19mm:7pcs	27mm:5pcs
14mm:8pcs	21mm:7pcs	

**14207M**  Socket Set  
Juego de Vasos



**14208M**  Socket Set  
Juego de Vasos



**14241M**  Socket Set  
Juego de Vasos

**14241M-05** 



**14242M**  Socket Set  
Juego de Vasos



**14245M-00**  Socket Set  
Juego de Vasos

**14245M-05** 



**S14240M**  Display Stand  
Expositor



# Impact Sockets 5/8"

HAND MANUALES  
Z-SERIES  
TITANIUM DE TITANIO  
ACCESSORIES ACCESORIOS  
SCREWDRIVERS DESTORNILLADORES  
IMPACT DE IMPACTO  
SLEEVE-DRIVE  
INDUSTRIAL INDUSTRIALES  
AUTOMOTIVE  
CONSTRUCTION CONSTRUCCION  
RENEWAL KITS JUEGOS DE PIEZAS REPLUESTO

## 15400M 6-point Sockets Vasos Hexagonales

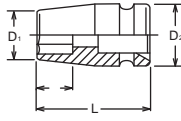

15400M (mm)	D <sub>1</sub> (mm)	D <sub>2</sub> (mm)	(mm)	L (mm)	(g)	(pcs.)	
14	24	35	10	47.5	220	10	*1
17	27.8	35	12	47.5	225	10	*1
19	30.3	35	13	47.5	225	10	*1
21	32.8	35	15	47.5	225	10	*1
22	34	35	15	47.5	225	10	*1
23	35.4	35	16	47.5	225	10	*1
24	36.5	35	16	50.5	245	10	*1
26	39	35	16	50.5	260	10	*1

\*1 Pin/O-Ring=1500A/B → P233

## 15400A 6-point Sockets Vasos Hexagonales

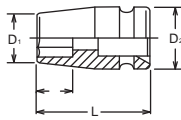

15400A (inch)	D <sub>1</sub> (mm)	D <sub>2</sub> (mm)	(mm)	L (mm)	(g)	(pcs.)	
9/16	24	35	10	47.5	220	10	*1
5/8	26.5	35	11	47.5	225	10	*1
11/16	27.8	35	12	47.5	225	10	*1
3/4	30.3	35	13	47.5	225	10	*1
13/16	32.8	35	15	47.5	225	10	*1
7/8	34	35	15	47.5	225	10	*1
15/16	36.5	35	16	50.5	245	10	*1

\*1 Pin/O-Ring=1500A/B → P233

## 15410M Surface Drive Sockets Vasos Surface Drive (de Contacto Curvo)

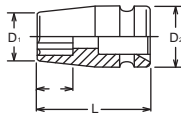

15410M (mm)	D <sub>1</sub> (mm)	D <sub>2</sub> (mm)	(mm)	L (mm)	(g)	(pcs.)	
14	24	35	10	47.5	220	10	*1
17	27.8	35	12	47.5	225	10	*1
19	30.3	35	13	47.5	225	10	*1
21	32.8	35	15	47.5	225	10	*1
22	34	35	15	47.5	225	10	*1
23	35.4	35	16	47.5	225	10	*1
24	36.5	35	16	50.5	245	10	*1
26	39	35	16	50.5	260	10	*1

\*1 Pin/O-Ring=1500A/B → P233

## SURFACE DRIVE

Surface drive sockets are designed to retain contact with flat sides of nut to transmit high torque and reduce nut wear. These sockets are ideal for use on polished nuts, aluminum nuts and nuts with worn out points.

Los vasos de contacto curvo se diseñan para mantener el contacto con las caras planas de la tuerca y transmitir un alto par reduciendo el desgaste de la tuerca. Estos vasos son ideales para utilizarse en tuercas pulidas, tuercas de aluminio y tuercas con puntas gastadas

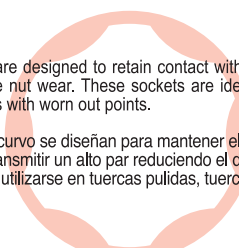

15300M (mm)	D <sub>1</sub> (mm)	D <sub>2</sub> (mm)	(mm)	L (mm)	(g)	(pcs.)	
14	24	35	14	90	295	10	*1
17	27.8	35	17	90	325	10	*1
19	30.3	35	19	90	350	10	*1
21	32.8	35	21	90	380	10	*1
22	34	35	22	90	390	10	*1

\*1 Pin/O-Ring=1500A/B → P233

15310M (mm)	D <sub>1</sub> (mm)	D <sub>2</sub> (mm)	(mm)	L (mm)	(g)	(pcs.)	
14	24	35	14	90	295	10	*1
17	27.8	35	17	90	325	10	*1
19	30.3	35	19	90	350	10	*1
21	32.8	35	21	90	380	10	*1
22	34	35	22	90	390	10	*1

\*1 Pin/O-Ring=1500A/B → P233

### Lock & Quick Release

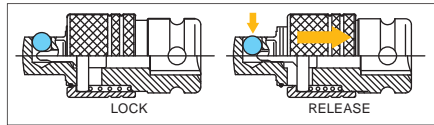

	L (mm)	(g)	(pcs.)	
15555AL	70	310	10	*1

\*1 Pin/O-Ring=1500A/B → P233

	L (mm)	(g)	(pcs.)	
15770	88	420	10	*1

\*1 Pin/O-Ring=1500A/B → P233

	(sq.)	(sq.)	L (mm)	(g)	(pcs.)	
15544A	5/8"	1/2"	46	165	10	*1
15544A-P	5/8"	1/2"	46	165	10	*1

\*1 Pin/O-Ring=1500A/B → P233

**⚠** Adapting down from bigger square drive to smaller square drive may lead to excessive torque load and possibly cause breakage. Always stay within safe torque of the smaller square drive.

	(sq.)	(sq.)	L (mm)	(g)	(pcs.)	
15566A	5/8"	3/4"	48	200	10	*1

\*1 Pin/O-Ring=1500A/B → P233

## 15300M 6-point Deep Sockets Vasos Hexagonales Largos

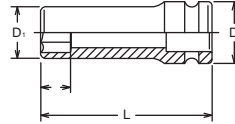

## 15310M Surface Drive Sockets, deep Vasos Surface Drive (de Contacto Curvo) Largos

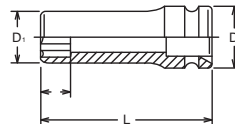

## 15555AL Adaptor (Quick Release) Adaptador (Extracción Rápida)

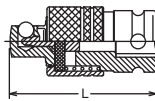

## 15770 Universal Joint Articulación Universal

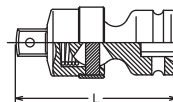

## 15544A Adaptor Adaptador

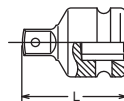

## 15566A Adaptor Adaptador

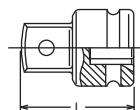

HAND MANUALES  
Z-SERIES  
TITANIUM DE TITANIO  
ACCESSORIES ACCESORIOS  
SCREWDRIVERS DESTORNILLADORES  
IMPACT DE IMPACTO  
SLEEVE-DRIVE  
INDUSTRIAL INDUSTRIALES  
AUTOMOTIVE  
CONSTRUCTION CONSTRUCCION  
RENEWAL KITS JUEGOS DE PIEZAS REPUESTO

# Impact Sockets 3/4"

HAND  
MANUALES

Z-SERIES

TITANIUM  
DE TITANIOACCESSORIES  
ACCESORIOSSCREWDRIVERS  
DESTORNILLADORESIMPACT  
DE IMPACTO

SLEEVE-DRIVE

INDUSTRIAL  
INDUSTRIALES

AUTOMOTIVE

CONSTRUCTION  
CONSTRUCCIONRENEWAL KITS  
JUEGOS DE PIEZAS/REPLUESTO

## 16400M • 16400A

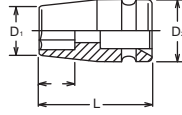
 6-point Sockets  
Vasos Hexagonales

16400A (inch)	D <sub>1</sub> (mm)	D <sub>2</sub> (mm)	(mm)	L (mm)	⚖️ (g)	📦 (pcs.)	⚡
11/16	30	44	12	50	355	5	*1
3/4	32.5	44	13	50	360	5	*1
13/16	35	44	15	50	374	5	*1
7/8	36.3	44	15	50	373	5	*1
15/16	38.8	44	16	50	370	5	*1
1	40	44	16	50	374	5	*1
1. 1/16	42.5	44	16	50	375	5	*1
1. 1/8	45	44	18	53	412	5	*1
1. 3/16	46.3	44	18	53	410	5	*1
1. 1/4	48.8	44	19	53	428	5	*1
1. 5/16	51.3	44	20	55	490	5	*1
1. 3/8	52.5	44	20	55	494	5	*1
1. 7/16	55	44	20	55	526	2	*1
1. 1/2	56.3	44	20	57	558	2	*1
1. 9/16	58.8	44	20	57	598	2	*1
1. 5/8	60	44	22	57	572	2	*1
1.11/16	62.5	44	23	62	720	2	*1
1. 3/4	65	44	23	62	757	2	*1
1.13/16	66.3	44	23	62	755	2	*1
1. 7/8	68.8	54	23	62	940	2	*2
1.15/16	70	54	23	62	912	2	*2
2	72.5	54	30	62	969	2	*2
2. 1/16	73.8	54	29	62	1011	2	*2
2. 1/8	76.3	54	29	62	1035	2	*2
2. 3/16	77.5	54	29	62	1056	2	*2
2. 1/4	80	54	32	65	1126	2	*2
2. 5/16	81.3	54	31	65	1163	2	*2
2. 3/8	83.8	54	31	65	1215	2	*2

## 16405M • 16405A

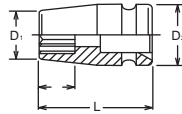
 12-point Sockets  
Vasos Bihexagonales

16405A (inch)	D <sub>1</sub> (mm)	D <sub>2</sub> (mm)	(mm)	L (mm)	⚖️ (g)	📦 (pcs.)	⚡
3/4	32.5	44	13	50	360	5	*1
13/16	35	44	15	50	374	5	*1
7/8	36.3	44	15	50	373	5	*1
15/16	38.8	44	16	50	370	5	*1
1	40	44	16	50	374	5	*1
1. 1/16	42.5	44	16	50	375	5	*1
1. 1/8	45	44	18	53	412	5	*1
1. 3/16	46.3	44	18	53	410	5	*1
1. 1/4	48.8	44	19	53	428	5	*1
1. 5/16	51.3	44	20	55	490	5	*1
1. 3/8	52.5	44	20	55	494	5	*1
1. 7/16	55	44	20	55	526	2	*1
1. 1/2	56.3	44	20	57	558	2	*1
1. 5/8	60	44	22	57	572	2	*1
1.11/16	62.5	44	23	62	720	2	*1
1. 3/4	65	44	23	62	757	2	*1
1. 7/8	68.8	54	23	62	940	2	*2
2	72.5	54	30	62	969	2	*2

16400M (mm)	D <sub>1</sub> (mm)	D <sub>2</sub> (mm)	(mm)	L (mm)	⚖️ (g)	📦 (pcs.)	⚡
17	30	44	12	50	355	5	*1
18	31.3	44	13	50	372	5	*1
19	32.5	44	13	50	360	5	*1
20	33.8	44	14	50	375	5	*1
21	35	44	15	50	374	5	*1
22	36.3	44	15	50	373	5	*1
23	37.5	44	16	50	373	5	*1
24	38.8	44	16	50	370	5	*1
25	40	44	16	50	374	5	*1
26	41.3	44	16	50	378	5	*1
27	42.5	44	16	50	375	5	*1
28	43.8	44	16	50	383	5	*1
29	45	44	18	53	412	5	*1
30	46.3	44	18	53	410	5	*1
31	47.5	44	18	53	426	5	*1
32	48.8	44	19	53	428	5	*1
33	50	44	20	55	470	5	*1
34	51.3	44	20	55	490	5	*1
35	52.5	44	20	55	494	5	*1
36	53.8	44	20	55	498	5	*1
37	55	44	20	55	526	2	*1
38	56.3	44	20	57	558	2	*1
39	57.5	44	20	57	579	2	*1
40	58.8	44	20	57	598	2	*1
41	60	44	22	57	572	2	*1
42	61.3	44	22	57	617	2	*1
43	62.5	44	23	62	720	2	*1
44	63.8	44	23	62	761	2	*1
45	65	44	23	62	757	2	*1
46	66.3	44	23	62	755	2	*1
47	67.5	54	23	62	805	2	*2
48	68.8	54	23	62	940	2	*2
49	70	54	23	62	912	2	*2
50	71.3	54	30	62	930	2	*2
52	73.8	54	29	62	1011	2	*2
54	76.3	54	29	62	1035	2	*2
55	77.5	54	29	62	1056	2	*2
56	78.8	54	29	62	1091	2	*2
57	80	54	32	65	1126	2	*2
58	81.3	54	31	65	1163	2	*2
59	82.5	54	31	65	1185	2	*2
60	83.8	54	31	65	1215	2	*2
65	90	54	30	65	1325	2	*2
New 70	96.3	54	34	70	1570	1	*2

\*1 C-Ring=1600C, Pin/O-Ring=1601A/B → P232-233  
 \*2 C-Ring=1801C, Pin/O-Ring=1602A/B

16405M (mm)	D <sub>1</sub> (mm)	D <sub>2</sub> (mm)	(mm)	L (mm)	⚖️ (g)	📦 (pcs.)	⚡
17	30	44	12	50	355	5	*1
18	31.3	44	13	50	372	5	*1
19	32.5	44	13	50	360	5	*1
20	33.8	44	14	50	375	5	*1
21	35	44	15	50	374	5	*1
22	36.3	44	15	50	373	5	*1
23	37.5	44	16	50	373	5	*1
24	38.8	44	16	50	370	5	*1
25	40	44	16	50	374	5	*1
26	41.3	44	16	50	378	5	*1
27	42.5	44	16	50	375	5	*1
28	43.8	44	16	50	383	5	*1
29	45	44	18	53	412	5	*1
30	46.3	44	18	53	410	5	*1
32	48.8	44	19	53	428	5	*1
33	50	44	20	55	470	5	*1
34	51.3	44	20	55	490	5	*1
36	53.8	44	20	55	498	5	*1
38	56.3	44	20	57	558	2	*1
41	60	44	22	57	572	2	*1
42	61.3	44	22	57	617	2	*1
46	66.3	44	23	62	755	2	*1
50	71.3	54	30	62	930	2	*2
52	73.8	54	29	62	1011	2	*2
55	77.5	54	29	62	1056	2	*2
60	83.8	54	31	65	1215	2	*2
New 65	90	54	30	65	1325	2	*2

\*1 C-Ring=1600C, Pin/O-Ring=1601A/B → P232-233  
 \*2 C-Ring=1801C, Pin/O-Ring=1602A/B

# 3/4" Impact Sockets



## 16401M • 16401A

6-point Sockets, Thin Walled  
Vasos Hexagonales de Pared Delgada

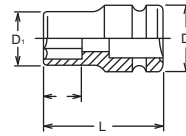

16401M (mm)	D <sub>1</sub> (mm)	D <sub>2</sub> (mm)	(mm)	L (mm)	(g)	(pcs.)	⊕
17	28	43	12	50	300	5	*1
18	29.3	43	13	50	300	5	*1
19	30.5	43	13	50	300	5	*1
20	31.8	43	14	50	302	5	*1
21	33	43	15	50	305	5	*1
22	34.3	43	15	50	310	5	*1
23	35.5	43	16	50	315	5	*1
24	36.8	43	16	50	325	5	*1
25	38	43	16	50	326	5	*1
26	39.3	43	16	50	330	5	*1
27	40.5	43	16	50	340	5	*1
28	41.8	43	16	50	345	5	*1
29	43	43	18	53	355	5	*1
30	44.3	43	18	53	365	5	*1
31	45.5	43	18	53	375	5	*1
32	46.8	43	19	53	385	5	*1
33	48	43	20	55	395	5	*1
34	49.3	43	20	55	420	5	*1
35	50.5	43	20	55	430	5	*1
36	51.8	43	20	55	440	5	*1
37	53	43	20	55	460	2	*1
38	54.3	43	20	57	472	2	*1
40	56.8	43	20	57	525	2	*1
41	58	43	22	57	555	2	*1
42	59.3	43	22	57	565	2	*1
44	61.8	43	23	62	670	2	*1
46	64.3	43	23	62	710	2	*1

\*1 C-Ring=1600C, Pin/O-Ring=1601A/B → P232-233

16401A (inch)	D <sub>1</sub> (mm)	D <sub>2</sub> (mm)	(mm)	L (mm)	(g)	(pcs.)	⊕
11/16	28	43	12	50	300	5	*1
3/4	30.5	43	13	50	300	5	*1
13/16	33	43	15	50	305	5	*1
7/8	34.3	43	15	50	310	5	*1
15/16	36.8	43	16	50	325	5	*1
1	38	43	16	50	326	5	*1
1. 1/16	40.5	43	16	50	340	5	*1
1. 1/8	43	43	18	53	355	5	*1
1. 3/16	44.3	43	18	53	365	5	*1
1. 1/4	46.8	43	19	53	385	5	*1
1. 5/16	49.3	30	20	55	437	5	*1
1. 3/8	50.5	43	20	55	430	5	*1
1. 7/16	53	43	20	55	460	2	*1
1. 1/2	54.3	43	20	57	472	2	*1
1. 9/16	56.8	43	20	57	525	2	*1
1. 5/8	58	43	22	57	555	2	*1
1.13/16	64.3	43	23	62	710	2	*1

\*1 C-Ring=1600C, Pin/O-Ring=1601A/B → P232-233

16425 (E)	D <sub>1</sub> (mm)	D <sub>2</sub> (mm)	(mm)	L (mm)	(g)	(pcs.)	⊕
E18	26.3	44	13	50	355	5	*1
E20	28.8	44	14.4	50	370	5	*1
E22	31.3	44	15.5	50	390	5	*1
E24	32.5	44	17	50	390	5	*1
E26	35	44	18.8	60	460	2	*1
E28	36.3	44	25.2	60	465	2	*1

\*1 C-Ring=1600C, Pin/O-Ring=1601A/B → P232-233

## 16425

TORX® Sockets  
Vasos TORX®

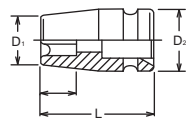

### TORX® (E)

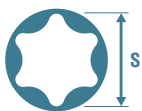

E	E4	E5	E6	E7	E8	E10	E11	E12	E14	E16	E18	E20	E22	E24	E26	E28
S (ref. mm)	3.83	4.72	5.69	6.17	7.47	9.37	10.03	11.12	12.85	14.71	16.64	18.41	20.24	22.10	23.85	25.65

16425-EPL (EPL)	D <sub>1</sub> (mm)	D <sub>2</sub> (mm)	(mm)	L (mm)	(g)	(pcs.)	⊕
24EPL	32.5	44	12.2	55	427	5	*1
32EPL	40	44	16.1	62	488	2	*1

\*1 C-Ring=1600C, Pin/O-Ring=1601A/B → P232-233

## 16425-EPL

TORX PLUS® Sockets  
Vasos TORX PLUS®

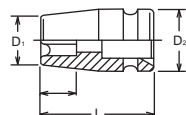

TORX is a registered trademark of Acument Intellectual Properties, LLC.  
TORX es una marca registrada de Acument Intellectual Properties, LLC.  
TORX PLUS is a registered trademark of Acument Intellectual Properties, LLC.  
TORX PLUS es una marca registrada de Acument Intellectual Properties, LLC.

HAND MANUALES  
Z-SERIES  
TITANIUM DE TITANIO  
ACCESSORIES ACCESORIOS  
SCREWDRIVERS DESTORNILLADORES  
IMPACT DE IMPACTO  
SLEEVE-DRIVE INDUSTRIAL INDUSTRIALES  
AUTOMOTIVE  
CONSTRUCTION CONSTRUCCION  
RENEWAL KITS JUEGOS DE PIEZAS REPUESTO



# Impact Sockets **3/4"**

HAND MANUALES  
Z-SERIES  
TITANIUM DE TITANIO  
ACCESSORIES ACCESORIOS  
SCREWDRIVERS DESTORNILLADORES  
IMPACT DE IMPACTO  
SLEEVE-DRIVE  
INDUSTRIAL INDUSTRIALES  
AUTOMOTIVE  
CONSTRUCTION CONSTRUCCION  
RENEWAL KITS JUEGOS DE PIEZAS REPLUSTO

## 16301X 6-point Semi-Deep Sockets, Thin Walled Vasos Hexagonales Medianos de Pared Delgada

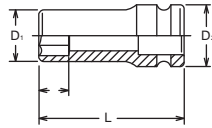

16301X (mm)	D <sub>1</sub> (mm)	D <sub>2</sub> (mm)	(mm)	L (mm)	(g)	(pcs.)	⚡
17	28	43	17	75	370	2	*1
18	29.3	43	18	75	380	2	*1
19	30.5	43	19	75	393	2	*1
20	31.8	43	20	75	400	2	*1
21	33	43	21	75	408	2	*1
22	34.3	43	22	75	418	2	*1
23	35.5	43	23	75	425	2	*1
24	36.8	43	24	75	435	2	*1
25	38	43	25	75	449	2	*1
26	39.3	43	26	75	455	2	*1
27	40.5	43	27	75	464	2	*1
28	41.8	43	28	75	479	2	*1
29	43	43	29	75	489	2	*1
30	44.3	43	30	75	506	2	*1
31	45.5	43	31	75	518	2	*1
32	46.8	43	32	75	535	2	*1
<b>New</b> 33	48	43	33	75	550	2	*1
35	50.5	43	35	75	585	2	*1
36	51.8	43	36	75	603	2	*1
37	53	43	37	75	645	2	*1
38	54.3	43	38	80	691	2	*1
40	56.8	43	38	80	725	2	*1
41	58	43	38	80	755	2	*1
46	64.3	43	38	80	808	2	*1

\*1 C-Ring=1600C, Pin/O-Ring=1601A/B → P232-233

## 16300M • 16300A 6-point Sockets, deep Vasos Hexagonales Largos

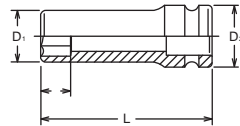

16300M (mm)	D <sub>1</sub> (mm)	D <sub>2</sub> (mm)	(mm)	L (mm)	(g)	(pcs.)	⚡
17	30	44	17	100	544	2	*1
18	31.3	44	18	100	642	2	*1
19	32.5	44	19	100	655	2	*1
20	33.8	44	20	100	680	2	*1
21	35	44	21	100	700	2	*1
22	36.3	44	22	100	700	2	*1
23	37.5	44	23	100	720	2	*1
24	38.8	44	24	100	705	2	*1
25	40	44	25	100	715	2	*1
26	41.3	44	26	100	760	2	*1
27	42.5	44	27	100	765	2	*1
28	43.8	44	28	100	800	2	*1
29	45	44	29	100	835	2	*1
30	46.3	44	30	100	840	2	*1
31	47.5	44	31	100	815	2	*1
32	48.8	44	32	100	875	2	*1
33	50	44	33	100	920	2	*1
34	51.3	44	34	100	950	2	*1
35	52.5	44	35	100	980	2	*1
36	53.8	44	36	100	960	2	*1
37	55	44	37	100	970	2	*1
38	56.3	44	38	100	990	2	*1
40	58.8	44	38	100	1060	2	*1
41	60	44	38	100	1120	2	*1
42	61.3	44	38	100	1153	2	*1
43	62.5	44	38	100	1200	2	*1
46	66.3	44	38	100	1305	2	*1
50	71.3	54	61	100	1469	2	*2
55	77.5	54	59	100	1620	2	*2

\*1 C-Ring=1600C, Pin/O-Ring=1601A/B → P232-233  
\*2 C-Ring=1801C, Pin/O-Ring=1602A/B

16300A (inch)	D <sub>1</sub> (mm)	D <sub>2</sub> (mm)	(mm)	L (mm)	(g)	(pcs.)	⚡
3/4	32.5	44	19	100	655	2	*1
13/16	35	44	21	100	700	2	*1
7/8	36.3	44	22	100	700	2	*1
15/16	38.8	44	24	100	705	2	*1
1	40	44	25	100	715	2	*1
1. 1/16	42.5	44	27	100	765	2	*1
1. 1/8	45	44	29	100	835	2	*1
1. 3/16	46.3	44	30	100	840	2	*1
1. 1/4	48.8	44	32	100	875	2	*1
1. 5/16	51.3	44	34	100	950	2	*1
1. 3/8	52.5	44	35	100	980	2	*1
1. 7/16	55	44	37	100	970	2	*1
1. 1/2	56.3	44	38	100	990	2	*1
1. 9/16	58.8	44	38	100	1060	2	*1
1. 5/8	60	44	38	100	1120	2	*1
1.11/16	62.5	44	38	100	1200	2	*1
1. 3/4	65	44	38	100	1284	2	*1
1.13/16	66.3	44	38	100	1305	2	*1
1. 7/8	68.8	54	38	100	1561	2	*2
2	72.5	54	60	100	1516	2	*2

\*1 C-Ring=1600C, Pin/O-Ring=1601A/B → P232-233  
\*2 C-Ring=1801C, Pin/O-Ring=1602A/B

# 3/4" Impact Sockets



## 16301M • 16301A

6-point Deep Sockets, Thin Walled  
Vasos Hexagonales Largos de Pared Delgada

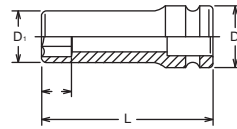

16301M (mm)	D <sub>1</sub> (mm)	D <sub>2</sub> (mm)	(mm)	L (mm)	(g)	(pcs.)	⚡
17	28	43	17	100	470	2	*1
18	29.3	43	18	100	475	2	*1
19	30.5	43	19	100	480	2	*1
20	31.8	43	20	100	491	2	*1
21	33	43	21	100	505	2	*1
22	34.3	43	22	100	528	2	*1
23	35.5	43	23	100	542	2	*1
24	36.8	43	24	100	560	2	*1
25	38	43	25	100	581	2	*1
26	39.3	43	26	100	600	2	*1
27	40.5	43	27	100	610	2	*1
28	41.8	43	28	100	639	2	*1
29	43	43	29	100	650	2	*1
30	44.3	43	30	100	670	2	*1
31	45.5	43	31	100	690	2	*1
32	46.8	43	32	100	715	2	*1
33	48	43	33	100	730	2	*1
34	49.3	43	34	100	750	2	*1
35	50.5	43	35	100	785	2	*1
36	51.8	43	36	100	830	2	*1
37	53	43	37	100	850	2	*1
38	54.3	43	38	100	885	2	*1
40	56.8	43	38	100	925	2	*1
41	58	43	38	100	970	2	*1
42	59.3	43	38	100	990	2	*1
46	64.3	43	38	100	1150	2	*1

\*1 C-Ring=1600C, Pin/O-Ring=1601A/B → P232-233

16301A (inch)	D <sub>1</sub> (mm)	D <sub>2</sub> (mm)	(mm)	L (mm)	(g)	(pcs.)	⚡
11/16	28	43	17	100	470	2	*1
3/4	30.5	43	19	100	480	2	*1
13/16	33	43	21	100	505	2	*1
7/8	34.3	43	22	100	528	2	*1
15/16	36.8	43	24	100	560	2	*1
1	38	43	25	100	581	2	*1
1. 1/16	40.5	43	27	100	610	2	*1
1. 1/8	43	43	29	100	650	2	*1
1. 3/16	44.3	43	30	100	670	2	*1
1. 1/4	46.8	43	32	100	715	2	*1
1. 3/8	50.5	43	35	100	785	2	*1
1. 7/16	53	43	37	100	850	2	*1
1. 1/2	54.3	43	38	100	885	2	*1
1. 9/16	56.8	43	38	100	925	2	*1
1. 5/8	58	43	38	100	970	2	*1
1.13/16	64.3	43	38	100	1150	2	*1

\*1 C-Ring=1600C, Pin/O-Ring=1601A/B → P232-233

16305M (mm)	D <sub>1</sub> (mm)	D <sub>2</sub> (mm)	(mm)	L (mm)	(g)	(pcs.)	⚡
17	30	44	17	100	544	2	*1
19	32.5	44	19	100	655	2	*1
21	35	44	21	100	700	2	*1
22	36.3	44	22	100	700	2	*1
23	37.5	44	23	100	720	2	*1
24	38.8	44	24	100	715	2	*1
26	41.3	44	26	100	760	2	*1
27	42.5	44	27	100	765	2	*1
28	43.8	44	28	100	800	2	*1
29	45	44	29	100	835	2	*1
30	46.3	44	30	100	840	2	*1
32	48.8	44	32	100	875	2	*1
35	52.5	44	35	100	980	2	*1
36	53.8	44	36	100	960	2	*1
38	56.3	44	38	100	990	2	*1
41	60	44	38	100	1120	2	*1
46	66.3	44	38	100	1305	2	*1

\*1 C-Ring=1600C, Pin/O-Ring=1601A/B → P232-233

## 16305M

12-point Sockets, deep  
Vasos Bihexagonales Largos

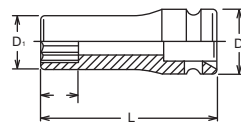

16325 (E)	D <sub>1</sub> (mm)	D <sub>2</sub> (mm)	(mm)	L (mm)	(g)	(pcs.)	⚡
E18	26.3	44	13.5	100	520	2	*1
E20	28.8	44	14.4	100	560	2	*1
E22	31.3	44	15.5	100	600	2	*1
E24	32.5	44	17.5	100	630	2	*1

\*1 C-Ring=1600C, Pin/O-Ring=1601A/B → P232-233

## 16325

TORX® Deep Sockets  
Vasos TORX® Largos

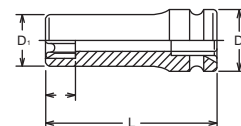

HAND MANUALES  
Z-SERIES  
TITANIUM DE TITANIO  
ACCESSORIES ACCESORIOS  
SCREWDRIVERS DESTORNILLADORES  
IMPACT DE IMPACTO  
SLEEVE-DRIVE INDUSTRIAL  
AUTOMOTIVE  
CONSTRUCTION CONSTRUCCION  
RENEWAL KITS JUEGOS DE PIEZAS REPUESTO

# Impact Sockets **3/4"**

HAND MANUALES  
Z-SERIES  
TITANIUM DE TITANIO  
ACCESSORIES ACCESORIOS  
SCREWDRIVERS DESTORNILLADORES  
IMPACT DE IMPACTO  
SLEEVE-DRIVE  
INDUSTRIAL INDUSTRIALES  
AUTOMOTIVE  
CONSTRUCTION CONSTRUCCION  
RENEWAL KITS JUEGOS DE PIEZAS REPLETO

## 16106-16 Hex bit sockets Vasos con Punta Hexagonal

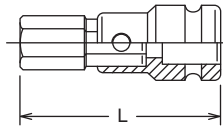

16106.16 (mm)	L (mm)	(g)	(pce.)	
10	76	416	1	*1
12	76	422	1	*1
13	76	426	1	*1
14	76	430	1	*1
16	76	439	1	*1
17	76	443	1	*1
18	76	448	1	*1
19	76	450	1	*1
22	76	473	1	*1

16106.16 (inch)	L (mm)	(g)	(pce.)	
1/2	76	426	1	*1
9/16	76	430	1	*1
5/8	76	439	1	*1
3/4	76	450	1	*1

\*1 C-Ring=1600C, Pin/O-Ring=1601A/B → P232-233

## 16106 Bit Holder, For 107-16 Porta Punta

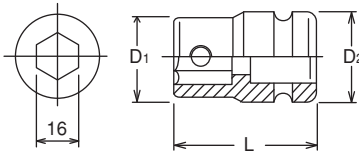

16106	D1 (mm)	D2 (mm)	L (mm)	(g)	(pcs.)	
16106	32	44	52	370	2	*1

\*1 C-Ring=1600C, Pin/O-Ring=1601A/B → P232-233

 Replacement Screw : M6x10, ●3mm

## 107-16 Bits for Inhex Screws Puntas para Tornillos Inhex

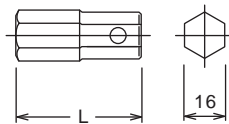

107.16 (mm)	L (mm)	(g)	(pcs.)
10	40	46	10
12	40	52	10
13	40	56	10
14	40	60	10
16	40	69	10
17	40	73	10
18	40	78	10
19	40	80	10
22	40	97	10

107.16 (inch)	L (mm)	(g)	(pcs.)
1/2	40	56	10
9/16	40	60	10
5/8	40	69	10
3/4	40	80	10

## 107-16 (T) TORX® Bits Puntas TORX®

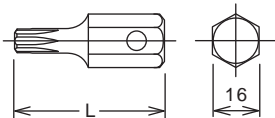

107.16 (T)	L (mm)	(g)	(pcs.)
T55	50	57	10
T60	50	64	10
T70	50	73	10

## 107-16 (XZN) XZN Bits Puntas XZN

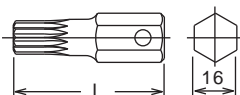

107.16 (XZN)	L (mm)	(g)	(pcs.)
M14	60	83	10
M16	60	93	10
M18	60	103	10

16107.22 (mm)	L (mm)	(g)	(pce.)	
19	88	670	1	*1
22	88	692	1	*1
24	88	706	1	*1
27	88	730	1	*1
30	88	757	1	*1
32	93	783	1	*1

\*1 C-Ring=1600C, Pin/O-Ring=1601A/B → P232-233



16107	D <sub>1</sub> (mm)	D <sub>2</sub> (mm)	L (mm)	(g)	(pcs.)	
16107	44	44	60	530	2	*1

\*1 C-Ring=1600C, Pin/O-Ring=1601A/B → P232-233

Replacement Screw : M8x14, 4mm

107.22 (mm)	L (mm)	(g)	(pcs.)
17	50	120	10
19	50	140	10
22	50	162	10
24	50	176	10
27	50	200	10
30	50	227	10
32	55	243	10

107.22 (T)	L (mm)	(g)	(pcs.)
T 80	60	141	10
T 90	60	155	10
T100	60	170	10

## 16107-22 Hex bit sockets Vasos con Punta Hexagonal

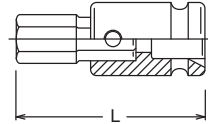

## 16107 Bit Holder Porta Punta

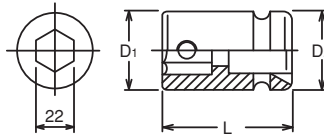

## 107-22 Bits for Inhex Screws Puntas para Tornillos Inhex

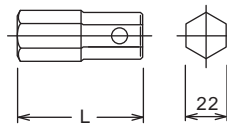

## 107-22 (T) TORX® Bits Puntas TORX®

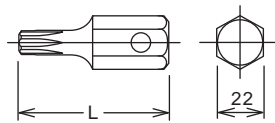

## 16760-150 · -175 · -200 · -250 · -330

Extension Bars Alargaderas

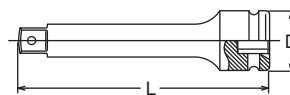

16760	D (mm)	L (mm)	(g)	(pce.)	
150	44	150	775	1	*1
175	44	175	870	1	*1
200	44	200	955	1	*1
250	44	250	1150	1	*1
330	44	330	1460	1	*1

\*1 C-Ring=1600C, Pin/O-Ring=1601A/B → P232-233

HAND MANUALES  
Z-SERIES  
TITANIUM DE TITANIO  
ACCESSORIES ACCESORIOS  
SCREWDRIVERS DESTORNILLADORES  
IMPACT DE IMPACTO  
SLEEVE-DRIVE INDUSTRIAL INDUSTRIALES  
AUTOMOTIVE  
CONSTRUCTION CONSTRUCCION  
RENEWAL KITS JUEGOS DE PIEZAS REPUESTO

# Impact Sockets **3/4"**

HAND MANUALES  
Z-SERIES  
TITANIUM DE TITANIO  
ACCESSORIES ACCESORIOS  
SCREWDRIVERS DESTORNILLADORES  
IMPACT DE IMPACTO  
SLEEVE-DRIVE  
INDUSTRIAL INDUSTRIALES  
AUTOMOTIVE  
CONSTRUCTION CONSTRUCCION  
RENEWAL KITS JUEGOS DE PIEZAS REPLUESTO

## 16666AL Adaptor (Quick Release) Adaptador (Extracción Rápida)

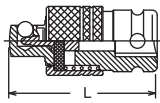

### Lock & Quick Release

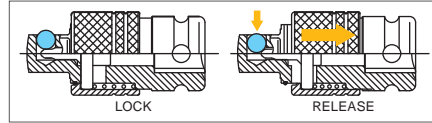

	L (mm)	(g)	(pcs.)	
16666AL	75	660	2	*1

\*1 C-Ring=1600C, Pin/O-Ring=1601A/B → P232-233

## 16770 Universal Joint Articulación Universal

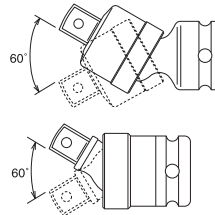
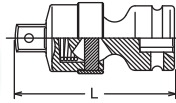

## 16771 Universal Joint Articulación Universal

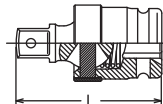

	L (mm)	(g)	(pce.)	
16770	106	790	1	*1
16771	95	720	1	*1

\*1 C-Ring=1600C, Pin/O-Ring=1601A/B → P232-233

## 16644A · 16655A Adaptors Adaptadores No Warranty Sin Garantía ⚠

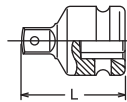

	(sq.)	(sq.)	L (mm)	(g)	(pce.)	
16644A	3/4"	1/2"	52	310	1	*1
16644A-B	3/4"	1/2"	52	310	1	*1
16644A-P	3/4"	1/2"	52	310	1	*1

	(sq.)	(sq.)	L (mm)	(g)	(pce.)	
16655A	3/4"	5/8"	53	336	1	*1

\*1 C-Ring=1600C, Pin/O-Ring=1601A/B → P232-233

⚠ Adapting down to a smaller square drive may lead to excessive torque load and possibly cause breakage. Always stay within limit torque of the smaller square drive.

## 16688A Adaptor Adaptador

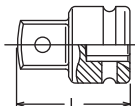

	(sq.)	(sq.)	L (mm)	(g)	(pce.)	
16688A	3/4"	1"	62	435	1	*1
16688A-250	3/4"	1"	250	1400	1	*1
16688A-330	3/4"	1"	330	1880	1	*1

\*1 C-Ring=1600C, Pin/O-Ring=1601A/B → P232-233

## 16688A-250 · -330 Adaptors Adaptadores





## 16201M • 16201A Socket Sets Juegos de Vasos





<b>16201M</b>	13 Pieces Set/△=6,800g
METAL CASE:W320xH110xT70mm	
Sockets	
 <b>16400M</b> 6-pt. Sockets	19, 21, 22, 23, 24, 26, 27, 30, 32, 33, 36, 38, 41

<b>16201A</b>	11 Pieces Set/△=6,000g
METAL CASE:W320xH110xT70mm	
Sockets	
 <b>16400A</b> 6-pt. Sockets	3/4, 7/8, 15/16, 1, 1.1/16, 1.1/8, 1.1/4, 1.5/16, 1.3/8, 1.7/16, 1.1/2

## 16201M-01 • 16201A-01 Socket Sets Juegos de Vasos



<b>16201M-01</b>	13 Pieces Set/△=6,000g
METAL CASE:W320xH110xT70mm	
Sockets	
 <b>16401M</b> 6-pt. Sockets, Thin-walled	19, 21, 22, 23, 24, 26, 27, 30, 32, 33, 36, 38, 41

<b>16201A-01</b>	11 Pieces Set/△=5,400g
METAL CASE:W320xH110xT70mm	
Sockets	
 <b>16401A</b> 6-pt. Sockets, Thin-walled	3/4, 7/8, 15/16, 1, 1.1/16, 1.1/8, 1.1/4, 1.5/16, 1.3/8, 1.7/16, 1.1/2

## 16245M Socket Sets Juegos de Vasos

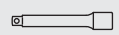
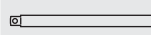

<b>16245M</b>	17 Pieces Set/△=12,000g
METAL CASE:W580xH200xT85mm	
Sockets	Accessories
 <b>16400M</b> 6-pt. Sockets	 <b>16760-175</b>
19, 21, 22, 24, 27, 29, 30, 32, 33, 35, 36, 38, 41, 46, 50	 <b>16760-330</b>

HAND  
MANUALES  
Z-SERIES  
TITANIUM  
DE TITANIO  
ACCESSORIES  
ACCESORIOS  
SCREWDRIVERS  
DESTORNILLADORES  
IMPACT  
DE IMPACTO  
SLEEVE-DRIVE  
INDUSTRIAL  
INDUSTRIALES  
AUTOMOTIVE  
CONSTRUCTION  
CONSTRUCCION  
RENEWAL KITS  
JUEGOS DE PIEZAS REPIESTO

## 18400M • 18400A

6-point Sockets  
Vasos Hexagonales

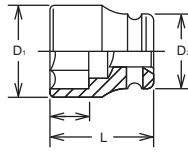

HAND MANUALES  
Z-SERIES  
TITANIUM DE TITANIO  
ACCESSORIES ACCESORIOS  
SCREWDRIVERS DESTORNILLADORES  
IMPACT DE IMPACTO  
SLEEVE-DRIVE  
INDUSTRIAL INDUSTRIALES  
AUTOMOTIVE  
CONSTRUCTION CONSTRUCCION  
RENEWAL KITS JUEGOS DE PIEZAS REPLISTO

18400M (mm)	D <sub>1</sub> (mm)	D <sub>2</sub> (mm)	(mm)	L (mm)	(g)	(pcs.)	
17	32.8	54	12	57	579	2	*1
<b>18</b>	34	54	13	57	590	2	*1
19	35.3	54	13	57	590	2	*1
21	37.8	54	15	57	605	2	*1
22	39	54	15	57	620	2	*1
23	40.3	54	16	57	615	2	*1
24	41.5	54	16	57	627	2	*1
25	42.8	54	16	57	620	2	*1
26	44	54	16	57	640	2	*1
27	45.3	54	16	57	627	2	*1
28	46.5	54	16	57	640	2	*1
29	47.8	54	18	57	657	2	*1
30	49	54	21	62	657	2	*1
31	50.3	54	21	62	687	2	*1
32	51.5	54	21	62	685	2	*1
33	52.8	54	21	62	685	2	*1
34	54	54	21	62	690	2	*1
35	55.3	54	21	62	710	2	*1
36	56.5	54	21	62	712	2	*1
37	57.8	54	21	62	735	2	*1
38	59	54	25	66	720	2	*1
40	61.5	54	25	66	850	2	*1
41	62.8	54	25	66	850	2	*1
42	64	54	25	66	905	2	*1
43	65.3	54	27	68	977	2	*1
44	66.5	54	27	68	970	2	*1
45	67.8	54	27	68	963	2	*1
46	69	54	29	70	1010	2	*1
47	70.3	54	36	70	997	2	*1
48	71.5	54	35	70	990	2	*1
50	74	54	35	70	1065	2	*1
52	76.5	54	40	75	1185	2	*1
54	79	54	40	75	1252	2	*1
55	80.3	54	39	75	1260	2	*1
56	81.5	54	39	75	1277	2	*1
58	84	54	39	75	1340	2	*1
60	86.5	54	39	75	1400	2	*1
62	89	54	38	75	1410	2	*1
63	90.3	54	38	75	1383	2	*1
65	92.8	54	38	75	1630	2	*1
67	95.3	54	38	75	1580	2	*1
68	96.5	54	37	75	1583	1	*1
70	99	54	37	75	1625	1	*1
75	105.3	86	37	80	2675	1	*2
80	111.5	86	41	85	2996	1	*2
85	117.8	86	37	90	3378	1	*2
90	124	86	40	95	3871	1	*2
95	130.3	86	43	100	4500	1	*2

18400A (inch)	D <sub>1</sub> (mm)	D <sub>2</sub> (mm)	(mm)	L (mm)	(g)	(pcs.)	
11/16	32.8	54	12	57	579	2	*1
3/4	35.3	54	13	57	590	2	*1
13/16	37.8	54	15	57	605	2	*1
7/8	39	54	15	57	620	2	*1
15/16	41.5	54	16	57	627	2	*1
1	42.8	54	16	57	620	2	*1
1. 1/16	45.3	54	16	57	627	2	*1
1. 1/8	47.8	54	18	57	657	2	*1
1. 3/16	49	54	21	62	657	2	*1
1. 1/4	51.5	54	21	62	685	2	*1
1. 5/16	54	54	21	62	690	2	*1
1. 3/8	55.3	54	21	62	710	2	*1
1. 7/16	57.8	54	21	62	735	2	*1
1. 1/2	59	54	25	66	720	2	*1
1. 9/16	61.5	54	25	66	850	2	*1
1. 5/8	62.8	54	25	66	850	2	*1
1.11/16	65.3	54	27	68	977	2	*1
1. 3/4	67.8	54	27	68	963	2	*1
1.13/16	69	54	29	70	1010	2	*1
1. 7/8	71.5	54	35	70	990	2	*1
1.15/16	72.8	54	35	70	1000	2	*1
2	75.3	54	35	70	1060	2	*1
2. 1/16	76.5	54	40	75	1185	2	*1
2. 1/8	79	54	40	75	1252	2	*1
2. 3/16	80.3	54	39	75	1260	2	*1
2. 1/4	82.8	54	39	75	1340	2	*1
2. 5/16	84	54	39	75	1400	2	*1
2. 3/8	86.5	54	39	75	1400	2	*1
2. 7/16	89	54	38	75	1410	2	*1
2. 1/2	91.5	54	38	75	1498	2	*1
2. 9/16	92.8	54	38	75	1630	2	*1
2. 5/8	95.3	54	38	75	1580	2	*1
2.11/16	96.5	54	37	75	1583	1	*1
2. 3/4	99	54	37	75	1625	1	*1
2.13/16	101.5	86	37	80	2705	1	*2
2. 7/8	102.8	86	38	80	2629	1	*2
2.15/16	105.3	86	37	80	2675	1	*2
3	106.5	86	37	80	2705	1	*2
3. 1/16	109	86	42	85	2967	1	*2
3. 1/8	111.5	86	41	85	2996	1	*2
3. 1/4	115.3	86	44	90	3328	1	*2
3. 3/8	119	86	36	90	3389	1	*2
3. 1/2	124	86	40	95	3871	1	*2

\*1 C-Ring=1801C, Pin/O-Ring=1801A/B  
\*2 C-Ring=1802C, Pin/O-Ring=1802A/B

\*1 C-Ring=1801C, Pin/O-Ring=1801A/B  
\*2 C-Ring=1802C, Pin/O-Ring=1802A/B



## 18401M • 18401A

6-point Sockets, Thin Walled  
Vasos Hexagonales de Pared Delgada

18401M (mm)	D <sub>1</sub> (mm)	D <sub>2</sub> (mm)	(mm)	L (mm)	(g)	(pcs.)	⊕
17	29.8	53	12	57	481	2	*1
19	32.3	53	13	57	492	2	*1
21	34.8	53	15	57	512	2	*1
22	36	53	15	57	520	2	*1
24	38.5	53	16	57	520	2	*1
27	42.3	53	16	57	540	2	*1
30	46	53	21	62	572	2	*1
32	48.5	53	21	62	600	2	*1
33	49.8	53	21	62	613	2	*1
35	52.3	53	21	62	630	2	*1
36	53.5	53	21	62	635	2	*1
38	56	53	25	66	705	2	*1
41	59.8	53	25	66	740	2	*1
46	66	53	29	70	900	2	*1
50	71	53	35	70	940	2	*1

18401A (inch)	D <sub>1</sub> (mm)	D <sub>2</sub> (mm)	(mm)	L (mm)	(g)	(pcs.)	⊕
11/16	29.8	53	12	57	481	2	*1
3/4	32.3	53	13	57	492	2	*1
13/16	34.8	53	15	57	512	2	*1
7/8	36	53	15	57	520	2	*1
15/16	38.5	53	16	57	520	2	*1
1. 1/16	42.3	53	16	57	540	2	*1
1. 3/16	46	53	21	62	572	2	*1
1. 1/4	48.5	53	21	62	600	2	*1
1. 3/8	52.3	53	21	62	630	2	*1
1. 1/2	56	53	25	66	705	2	*1
1. 5/8	59.8	53	25	66	740	2	*1
1.13/16	66	53	29	70	900	2	*1

\*1 C-Ring=1801C, Pin/O-Ring=1801A/B → P232-233

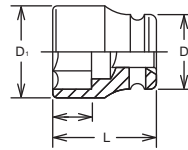

18405M (mm)	D <sub>1</sub> (mm)	D <sub>2</sub> (mm)	(mm)	L (mm)	(g)	(pcs.)	⊕
27	45.3	54	16	57	607	2	*1
30	49.5	54	21	62	657	2	*1
32	51.5	54	21	62	685	2	*1
33	52.8	54	21	62	690	2	*1
35	55.3	54	21	62	690	2	*1
36	56.5	54	21	62	692	2	*1
38	59	54	25	66	700	2	*1
40	61.5	54	25	66	830	2	*1
46	69	54	29	70	990	2	*1
50	74	54	35	70	1021	2	*1
55	80.3	54	39	75	1234	2	*1
56	81.5	54	39	75	1250	2	*1
60	86.5	54	39	75	1400	2	*1
65	92.8	54	38	75	1600	2	*1

18405A (inch)	D <sub>1</sub> (mm)	D <sub>2</sub> (mm)	(mm)	L (mm)	(g)	(pcs.)	⊕
3/4	35.3	54	13	57	590	2	*1
7/8	39	54	15	57	620	2	*1
1	42.8	54	16	57	620	2	*1
1. 1/8	47.8	54	18	57	660	2	*1
1. 3/16	49	54	21	62	660	2	*1
1. 1/4	51.5	54	21	62	690	2	*1
1. 3/8	55.3	54	21	62	710	2	*1
1. 7/16	57.8	54	21	62	735	2	*1
1. 1/2	59	54	25	66	720	2	*1
1. 3/4	67.8	54	27	68	970	2	*1
1.15/16	72.8	54	35	70	1000	2	*1

\*1 C-Ring=1801C, Pin/O-Ring=1801A/B → P232-233

## 18405M • 18405A

12-point Sockets  
Vasos Bihexagonales

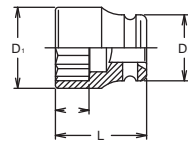

HAND  
MANUALES

Z-SERIES

TITANIUM  
DE TITANIO

ACCESSORIES  
ACCESORIOS

SCREWDRIVERS  
DESTORNILLADORES

IMPACT  
DE IMPACTO

SLEEVE-DRIVE

INDUSTRIAL  
INDUSTRIALES

AUTOMOTIVE

CONSTRUCTION  
CONSTRUCCION

RENEWAL KITS  
JUEGOS DE PIEZAS REPUESTO

# Impact Sockets 1"

HAND MANUALES  
Z-SERIES  
TITANIUM DE TITANIO  
ACCESSORIES ACCESORIOS  
SCREWDRIVERS DESTORNILLADORES  
IMPACT DE IMPACTO  
SLEEVE-DRIVE  
INDUSTRIAL INDUSTRIALES  
AUTOMOTIVE  
CONSTRUCTION CONSTRUCCION  
RENEWAL KITS JUEGOS DE PIEZAS/REPLUSTO

## 18301X

6-point Semi-Deep Sockets, Thin Walled  
Vasos Hexagonales Medianos de Pared Delgada

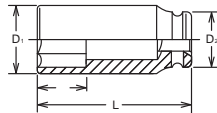

18301X (mm)	D <sub>1</sub> (mm)	D <sub>2</sub> (mm)	(mm)	L (mm)	(g)	(pcs.)	⚡
17	29.8	53	17	80	635	2	*1
19	32.3	53	19	80	655	2	*1
21	34.8	53	21	80	680	2	*1
22	36	53	22	80	686	2	*1
24	38.5	53	24	80	693	2	*1
27	42.3	53	27	80	745	2	*1
30	46	53	30	80	761	2	*1
32	48.5	53	32	85	770	2	*1
33	49.8	53	33	85	781	2	*1
35	52.3	53	35	85	800	2	*1
36	53.5	53	36	85	808	2	*1
38	56	53	38	85	865	2	*1
41	59.8	53	38	85	937	2	*1
46	66	53	38	85	1032	2	*1
50	71	53	55	85	1220	2	*1

\*1 C-Ring=1801C, Pin/O-Ring=1801A/B → P232-233

## 18300M • 18300A

6-point Sockets, deep  
Vasos Hexagonales Largos

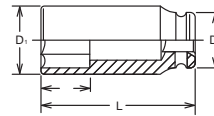

18300M (mm)	D <sub>1</sub> (mm)	D <sub>2</sub> (mm)	(mm)	L (mm)	(g)	(pcs.)	⚡
19	35.3	54	19	108	1010	2	*1
22	39	54	22	108	1010	2	*1
23	40.3	54	26	108	1063	2	*1
24	41.5	54	24	108	1060	2	*1
25	42.8	54	25	108	1085	2	*1
26	44	54	26	108	1133	2	*1
27	45.3	54	27	108	1125	2	*1
28	46.5	54	28	108	1140	2	*1
29	47.8	54	29	108	1120	2	*1
30	49	54	30	108	1179	2	*1
31	50.3	54	31	108	1125	2	*1
32	51.5	54	32	108	1200	2	*1
33	52.8	54	33	108	1200	2	*1
34	54	54	34	108	1280	2	*1
35	55.3	54	35	108	1300	2	*1
36	56.5	54	36	108	1280	2	*1
37	57.8	54	37	108	1320	2	*1
38	59	54	38	108	1423	2	*1
40	61.5	54	38	108	1415	2	*1
41	62.8	54	38	108	1450	2	*1
42	64	54	38	108	1550	2	*1
44	66.5	54	38	108	1636	2	*1
45	67.8	54	38	108	1660	2	*1
46	69	54	38	108	1680	2	*1
48	71.5	54	67	108	1500	2	*1
50	74	54	66	108	1650	2	*1
52	76.5	54	65	108	1770	2	*1
55	80.3	54	63	108	1855	2	*1
60	86.5	54	60	108	2047	2	*1
65	92.8	54	58	108	2310	2	*1
70	99	54	55	108	2440	1	*1
75	105.3	86	52	108	3646	1	*2
80	111.5	86	49	108	4039	1	*2
85	117.8	86	59	108	4000	1	*2
90	124	86	57	108	4200	1	*2
95	130.3	86	55	108	4400	1	*2

\*1 C-Ring=1801C, Pin/O-Ring=1801A/B

\*2 C-Ring=1802C, Pin/O-Ring=1802A/B

→ P232-233

18300A (inch)	D <sub>1</sub> (mm)	D <sub>2</sub> (mm)	(mm)	L (mm)	(g)	(pcs.)	⚡
11/16	32.8	54	17	108	978	2	*1
3/4	35.3	54	19	108	1010	2	*1
7/8	39	54	22	108	1010	2	*1
15/16	41.5	54	24	108	1060	2	*1
1	42.8	54	25	108	1085	2	*1
1. 1/16	45.3	54	27	108	1125	2	*1
1. 1/8	47.8	54	29	108	1120	2	*1
1. 3/16	49	54	30	108	1179	2	*1
1. 1/4	51.5	54	32	108	1200	2	*1
1. 5/16	54	54	34	108	1280	2	*1
1. 3/8	55.3	54	35	108	1300	2	*1
1. 7/16	57.8	54	37	108	1320	2	*1
1. 1/2	59	54	38	108	1423	2	*1
1. 9/16	61.5	54	38	108	1415	2	*1
1. 5/8	62.8	54	38	108	1450	2	*1
1.11/16	65.3	54	38	108	1577	2	*1
1. 3/4	67.8	54	38	108	1660	2	*1
1.13/16	69	54	38	108	1680	2	*1
1. 7/8	71.5	54	67	108	1500	2	*1
1.15/16	72.8	54	67	108	1570	2	*1
2	75.3	54	66	108	1605	2	*1
2. 1/16	76.5	54	65	108	1770	2	*1
2. 1/8	79	54	64	108	1812	2	*1
2. 3/16	80.3	54	63	108	1855	2	*1
2. 1/4	82.8	54	62	108	1916	2	*1
2. 5/16	84	54	61	108	1987	2	*1
2. 3/8	86.5	54	60	108	2047	2	*1
2. 7/16	89	54	59	108	2041	2	*1
2. 1/2	91.5	54	58	108	2250	2	*1
2. 9/16	92.8	54	58	108	2310	2	*1
2. 5/8	95.3	54	56	108	2370	1	*1
2. 3/4	99	54	55	108	2440	1	*1
2. 7/8	102.8	86	53	108	3600	1	*2
2.15/16	105.3	86	52	108	3646	1	*2
3	106.5	86	51	108	3677	1	*2
3. 1/16	109	86	50	108	3939	1	*2
3. 1/8	111.5	86	49	108	4039	1	*2
3. 3/16	112.8	86	48	108	4170	1	*2

\*1 C-Ring=1801C, Pin/O-Ring=1801A/B

\*2 C-Ring=1802C, Pin/O-Ring=1802A/B

→ P232-233



## 18301M · 18301A

6-point Deep Sockets, Thin Walled  
Vasos Hexagonales Largos de Parad De Igada

18301M (mm)	D <sub>1</sub> (mm)	D <sub>2</sub> (mm)	(mm)	L (mm)	(g)	(pcs.)	⚡
17	29.8	53	17	108	692	2	*1
New 18	31	53	18	108	710	2	*1
19	32.3	53	19	108	725	2	*1
New 20	33.5	53	20	108	740	2	*1
21	34.8	53	21	108	750	2	*1
22	36	53	22	108	770	2	*1
24	38.5	53	24	108	800	2	*1
27	42.3	53	27	108	860	2	*1
30	46	53	30	108	910	2	*1
32	48.5	53	32	108	970	2	*1
33	49.8	53	33	108	980	2	*1
New 34	51	53	34	108	980	2	*1
35	52.3	53	35	108	986	2	*1
36	53.5	53	36	108	992	2	*1
38	56	53	38	108	1025	2	*1
41	59.8	53	38	108	1213	2	*1
46	66	53	38	108	1400	2	*1
50	71	53	38	108	1435	2	*1

18301A (inch)	D <sub>1</sub> (mm)	D <sub>2</sub> (mm)	(mm)	L (mm)	(g)	(pcs.)	⚡
11/16	29.8	53	17	108	692	2	*1
3/4	32.3	53	19	108	725	2	*1
13/16	34.8	53	21	108	750	2	*1
7/8	36	53	22	108	770	2	*1
15/16	38.5	53	24	108	800	2	*1
1. 1/16	42.3	53	27	108	860	2	*1
1. 3/16	46	53	30	108	910	2	*1
1. 1/4	48.5	53	32	108	970	2	*1
1. 3/8	52.3	53	35	108	986	2	*1
1. 1/2	56	53	38	108	1025	2	*1
1. 5/8	59.8	53	38	108	1213	2	*1
1.13/16	66	53	38	108	1400	2	*1

\*1 C-Ring=1801C, Pin/O-Ring=1801A/B → P232-233

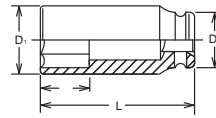

18104M (mm)	D <sub>1</sub> (mm)	D <sub>2</sub> (mm)	(mm)	L (mm)	(g)	(pcs.)	⚡
24	41.5	54	24	170	1327	1	*1
27	45.3	54	27	170	1375	1	*1
28	46.5	54	28	170	1390	1	*1
30	49	54	30	170	1407	1	*1
32	51.5	54	32	170	1537	1	*1
33	52.8	54	33	170	1590	1	*1
34	54	54	34	170	1670	1	*1
36	56.5	54	36	170	1800	1	*1

\*1 C-Ring=1801C, Pin/O-Ring=1801A/B → P232-233

## 18104M

Extra Long Sockets  
Vasos Extra-Largos

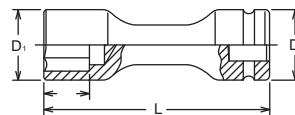

HAND MANUALES  
Z-SERIES  
TITANIUM DE TITANIO  
ACCESSORIES ACCESORIOS  
SCREWDRIVERS DESTORNILLADORES  
IMPACT DE IMPACTO  
SLEEVE-DRIVE  
INDUSTRIAL INDUSTRIALES  
AUTOMOTIVE  
CONSTRUCTION CONSTRUCCION  
RENEWAL KITS JUEGOS DE PIEZAS REPIESTO



HAND MANUALES  
Z-SERIES  
TITANIUM DE TITANIO  
ACCESSORIES ACCESORIOS  
SCREWDRIVERS DESTORNILLADORES  
IMPACT DE IMPACTO  
SLEEVE-DRIVE  
INDUSTRIAL INDUSTRIALES  
AUTOMOTIVE  
CONSTRUCTION CONSTRUCCION  
RENEWAL KITS JUEGOS DE PIEZAS REPLISTO

## 18106-16 Hex Bit Sockets Vasos con Punta Hexagonal



18106.16 (mm)	L (mm)	(g)	(pce.)	
10	92	686	1	*1
12	92	692	1	*1
13	92	696	1	*1
14	92	700	1	*1
16	92	709	1	*1
17	92	713	1	*1
18	92	718	1	*1
19	92	764	1	*1
22	92	781	1	*1

18106.16 (inch)	L (mm)	(g)	(pce.)	
1/2	92	696	1	*1
9/16	92	700	1	*1
5/8	92	709	1	*1
3/4	92	764	1	*1

\*1 C-Ring=1801C, Pin/O-Ring=1801A/B → P232-233

## 18106 Bit Holder Porta Punta



	D <sub>1</sub> (mm)	D <sub>2</sub> (mm)	L (mm)	(g)	(pcs.)	
18106	32	54	68	640	2	*1

\*1 C-Ring=1801C, Pin/O-Ring=1801A/B → P232-233

 Replacement Screw : M6x10 ● 3mm

## 107-16 Bits for Inhex Screws Puntas para Tornillos Inhex



107.16 (mm)	L (mm)	(g)	(pcs.)
10	40	46	10
12	40	52	10
13	40	56	10
14	40	60	10
16	40	69	10
17	40	73	10
18	40	78	10
19	40	80	10
22	40	97	10

107.16 (inch)	L (mm)	(g)	(pcs.)
1/2	40	56	10
9/16	40	60	10
5/8	40	69	10
3/4	40	80	10

## 107-16 (T) TORX® Bits Puntas TORX®



107.16 (T)	L (mm)	(g)	(pcs.)
T55	50	57	10
T60	50	64	10
T70	50	73	10

## 107-16 (XZN) XZN Bits Puntas XZN



107.16 (XZN)	L (mm)	(g)	(pcs.)
M14	60	83	10
M16	60	93	10
M18	60	103	10

18107.22 (mm)	L (mm)	(g)	(pcs.)	
19	98	910	1	*1
22	98	932	1	*1
24	98	946	1	*1
27	98	986	1	*1
30	98	1008	1	*1
32	103	1029	1	*1

\*1 C-Ring=1801C, Pin/O-Ring=1801A/B → P232-233

## 18107-22 Hex Bit Sockets Vasos con Punta Hexagonal

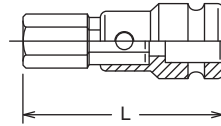

18107	D <sub>1</sub> (mm)	D <sub>2</sub> (mm)	L (mm)	(g)	(pcs.)	
18107	44	54	70	770	2	*1

\*1 C-Ring=1801C, Pin/O-Ring=1801A/B → P232-233

 Replacement Screw : M8x14, ●4mm

## 18107 Bit Holder Porta Punta

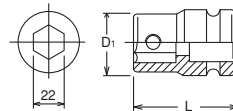

107.22 (mm)	L (mm)	(g)	(pcs.)
17	50	120	10
19	50	140	10
22	50	162	10
24	50	176	10
27	50	200	10
30	50	227	10
32	55	243	10

## 107-22 Bits for Inhex Screws Puntas para Tornillos Inhex

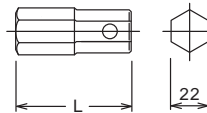

107.22 (T)	L (mm)	(g)	(pcs.)
T 80	60	141	10
T 90	60	155	10
T100	60	170	10

## 107-22 (T) TORX® Bits Puntas TORX®

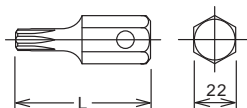

HAND MANUALES  
Z-SERIES  
TITANIUM DE TITANIO  
ACCESSORIES ACCESORIOS  
SCREWDRIVERS DESTORNILLADORES  
IMPACT DE IMPACTO  
SLEEVE-DRIVE INDUSTRIAL INDUSTRIALES  
AUTOMOTIVE  
CONSTRUCTION CONSTRUCCION  
RENEWAL KITS JUEGOS DE PIEZAS REPIESTO

HAND MANUALES  
Z-SERIES  
TITANIUM DE TITANIO  
ACCESSORIES ACCESORIOS  
SCREWDRIVERS DESTORNILLADORES  
IMPACT DE IMPACTO  
SLEEVE-DRIVE  
INDUSTRIAL INDUSTRIALES  
AUTOMOTIVE  
CONSTRUCTION CONSTRUCCION  
RENEWAL KITS JUEGOS DE PIEZAS REPLUESTO

## 18760-175 · -200 · -250 · -330 Extension Bars Alargaderas

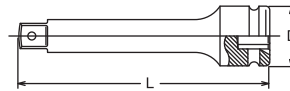

18760	D (mm)	L (mm)	(g)	(pce.)	Ⓢ
175	54	175	1400	1	*1
200	54	200	1580	1	*1
250	54	250	1885	1	*1
330	54	330	2380	1	*1

\*1 C-Ring=1801C, Pin/O-Ring=1801A/B → P232-233

## 18888AL Adaptor (Quick Release) Adaptador (Extracción Rápida)

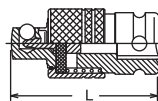

### Lock & Quick Release

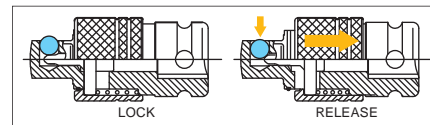

18888AL	L (mm)	(g)	(pce.)	Ⓢ
18888AL	95	980	2	*1

\*1 C-Ring=1801C, Pin/O-Ring=1801A/B → P232-233

## 18770 Universal Joint Articulación Universal

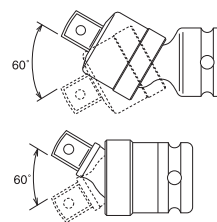
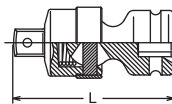

18770	L (mm)	(g)	(pce.)	Ⓢ
18770	127	1210	1	*1
18771	115	1210	1	*1

\*1 C-Ring=1801C, Pin/O-Ring=1801A/B → P232-233

## 18771 Universal Joint Articulación Universal

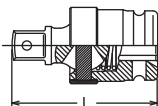

	(sq.)	(sq.)	L (mm)	(g)	(pce.)	
<b>18866A</b>	1"	3/4"	65	580	1	*1
<b>18866A-200</b>	1"	3/4"	200	1100	1	*1

\*1 C-Ring=1801C, Pin/O-Ring=1801A/B → P232-233

**⚠** Adapting down from bigger square drive to smaller square drive may lead to excessive torque load and possibly cause breakage. Always stay within safe torque of the smaller square drive.

## 18866A Adaptors Adaptadores No Warranty Sin Garantia **⚠**

### 18866A-200 **⚠**

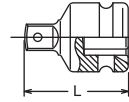

	(sq.)	(sq.)	L (mm)	(g)	(pce.)	
<b>18877A</b>	1"	1.1/2"	80	935	1	*1

\*1 C-Ring=1801C, Pin/O-Ring=1801A/B → P232-233

## 18877A Adaptor Adaptador

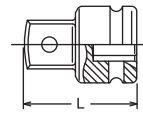

# Impact Sockets 1-1/2"

## 17400M • 17400A

6-point Sockets  
Vasos Hexagonales

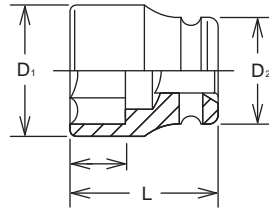

17400M (mm)	D <sub>1</sub> (mm)	D <sub>2</sub> (mm)	(mm)	L (mm)	(g)	(pce.)	⚡
<b>36</b>	62	86	20	77	2126	1	*1
<b>41</b>	68	86	22	80	2346	1	*1
<b>42</b>	70	86	22	80	2330	1	*1
<b>46</b>	74	86	26	84	2360	1	*1
<b>50</b>	79	86	27	84	2400	1	*1
<b>52</b>	82	86	38	84	2340	1	*1
<b>54</b>	84	86	38	84	2340	1	*1
<b>55</b>	85	86	44	90	2450	1	*1
<b>58</b>	88	86	44	90	2510	1	*1
<b>60</b>	91	86	43	90	2640	1	*1
<b>65</b>	97	86	48	95	3050	1	*1
<b>70</b>	103	86	52	100	3350	1	*1
<b>75</b>	108	86	56	105	3700	1	*1
<b>80</b>	115	86	60	110	4240	1	*1
<b>85</b>	122	86	60	110	4550	1	*1
<b>90</b>	128	86	60	112	4840	1	*1
<b>95</b>	135	127	52	112	7660	1	*2
<b>100</b>	140	127	53	115	7700	1	*2
<b>105</b>	146	127	57	120	8000	1	*2
<b>110</b>	153	127	60	124	9200	1	*2
<b>115</b>	160	127	62	128	10700	1	*2
<b>120</b>	166	127	64	132	11200	1	*2
<b>125</b>	173	127	67	136	13000	1	*2
<b>130</b>	180	127	69	140	14200	1	*2
<b>135</b>	186	127	73	145	14940	1	*2
<b>140</b>	190	127	76	150	15600	1	*2
<b>150</b>	200	127	83	160	16500	1	*2

17400A (inch)	D <sub>1</sub> (mm)	D <sub>2</sub> (mm)	(mm)	L (mm)	(g)	(pce.)	⚡
<b>1. 5/8</b>	68	86	22	80	2346	1	*1
<b>1.11/16</b>	71	86	22	80	2300	1	*1
<b>1. 3/4</b>	73	86	22	80	2290	1	*1
<b>1.13/16</b>	74	86	26	84	2360	1	*1
<b>1. 7/8</b>	77	86	26	84	2440	1	*1
<b>1.15/16</b>	79	86	27	84	2400	1	*1
<b>2</b>	80	86	27	84	2420	1	*1
<b>2. 1/16</b>	82	86	38	84	2340	1	*1
<b>2. 1/8</b>	84	86	38	84	2340	1	*1
<b>2. 3/16</b>	85	86	44	90	2450	1	*1
<b>2. 1/4</b>	87	86	43	90	2460	1	*1
<b>2. 5/16</b>	88	86	44	90	2510	1	*1
<b>2. 3/8</b>	91	86	43	90	2640	1	*1
<b>2. 7/16</b>	93	86	47	95	2860	1	*1
<b>2. 1/2</b>	96	86	47	95	3000	1	*1
<b>2. 9/16</b>	97	86	48	95	3050	1	*1
<b>2. 5/8</b>	100	86	51	100	3300	1	*1
<b>2.11/16</b>	101	86	51	100	3300	1	*1
<b>2. 3/4</b>	103	86	52	100	3350	1	*1
<b>2.13/16</b>	105	86	55	105	3670	1	*1
<b>2. 7/8</b>	106	86	55	105	3610	1	*1
<b>2.15/16</b>	108	86	56	105	3700	1	*1
<b>3</b>	108	86	55	105	3680	1	*1
<b>3. 1/8</b>	115	86	60	110	4240	1	*1
<b>3. 1/4</b>	118	86	59	110	4370	1	*1
<b>3. 3/8</b>	123	86	60	110	4570	1	*1
<b>3. 1/2</b>	128	86	60	112	4840	1	*1
<b>3. 5/8</b>	132	86	52	112	5500	1	*1
<b>3. 3/4</b>	135	127	52	112	7660	1	*2
<b>3. 7/8</b>	140	127	53	115	7700	1	*2
<b>4</b>	146	127	57	120	8000	1	*2
<b>4. 1/8</b>	146	127	57	120	8000	1	*2
<b>4. 1/4</b>	153	127	60	124	9200	1	*2
<b>4. 1/2</b>	160	127	62	128	10700	1	*2
<b>4. 5/8</b>	166	127	64	132	11200	1	*2
<b>4. 3/4</b>	168	127	64	132	11200	1	*2
<b>4. 7/8</b>	173	127	67	136	13000	1	*2
<b>5</b>	180	127	69	140	14200	1	*2
<b>5. 1/4</b>	186	127	73	145	14940	1	*2
<b>6</b>	205	127	88	165	16500	1	*2
<b>6. 1/2</b>	205	127	94	175	17500	1	*2

\*1 C-Ring=1700C, Pin/O-Ring=1701A/B → P232-233  
\*2 Pin/O-Ring=1702A/B



# 1-1/2" Impact Sockets

17405M (mm)	D <sub>1</sub> (mm)	D <sub>2</sub> (mm)	(mm)	L (mm)	(g)	(pcs.)	⊕
46	74	86	26	84	2360	1	*1
50	79	86	27	84	2400	1	*1
55	85	86	44	90	2450	1	*1
60	91	86	43	90	2640	1	*1
65	97	86	48	95	3050	1	*1
70	103	86	52	100	3350	1	*1
75	108	86	56	105	3700	1	*1
80	115	86	60	110	4240	1	*1
85	122	86	60	110	4550	1	*1
90	128	86	60	112	4840	1	*1

17405A (inch)	D <sub>1</sub> (mm)	D <sub>2</sub> (mm)	(mm)	L (mm)	(g)	(pcs.)	⊕
1.11/16	71	86	22	80	2300	1	*1
1.3/4	73	86	22	80	2290	1	*1
1.7/8	77	86	26	84	2440	1	*1
1.15/16	79	86	27	84	2400	1	*1
2	80	86	27	84	2420	1	*1
2.1/16	82	86	38	84	2340	1	*1
2.1/8	84	86	38	84	2340	1	*1
2.3/16	85	86	44	90	2450	1	*1
2.1/4	87	86	43	90	2460	1	*1
2.3/8	91	86	43	90	2640	1	*1
2.7/16	93	86	47	95	2860	1	*1
2.1/2	96	86	47	95	3000	1	*1
2.9/16	97	86	48	95	3050	1	*1
2.5/8	100	86	51	100	3300	1	*1

\*1 C-Ring=1700C, Pin/O-Ring=1701A/B → P232-233

## 17405M • 17405A

12-point Sockets  
Vasos Bihexagonales

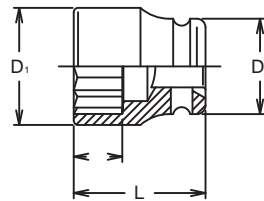

## 17300M • 17300A

6-point Deep Sockets  
Vasos Hexagonales Largos

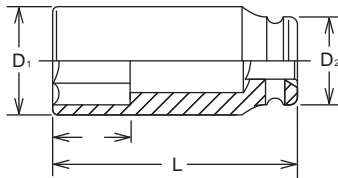

17300M (mm)	D <sub>1</sub> (mm)	D <sub>2</sub> (mm)	(mm)	L (mm)	(g)	(pce.)	⊕
41	68	86	27	115	3080	1	*1
42	70	86	27	115	3140	1	*1
46	74	86	28	125	3440	1	*1
50	79	86	30	135	3840	1	*1
54	84	86	30	135	4160	1	*1
55	85	86	33	135	4130	1	*1
60	91	86	35	135	4370	1	*1
65	97	86	38	145	5260	1	*1
70	103	86	40	145	5780	1	*1
75	108	86	42	155	6580	1	*1
80	115	86	46	165	7740	1	*1
85	122	86	49	165	7420	1	*1
90	128	86	52	175	9100	1	*1
95	135	127	55	175	12160	1	*2
100	140	127	58	185	11450	1	*2
105	146	127	62	195	13850	1	*2
110	153	127	65	195	15500	1	*2
115	160	127	68	195	17160	1	*2
120	166	127	72	205	18800	1	*2
125	173	127	74	205	19570	1	*2
130	180	127	76	205	20310	1	*2

\*1 C-Ring=1700C, Pin/O-Ring=1701A/B → P232-233  
\*2 Pin/O-Ring=1702A/B

17300A (inch)	D <sub>1</sub> (mm)	D <sub>2</sub> (mm)	(mm)	L (mm)	(g)	(pce.)	⊕
1.5/8	68	86	27	115	3080	1	*1
1.11/16	71	86	27	115	3180	1	*1
1.3/4	73	86	27	115	3210	1	*1
1.13/16	74	86	28	125	3440	1	*1
1.7/8	77	86	28	125	3550	1	*1
1.15/16	79	86	28	125	3590	1	*1
2	80	86	30	135	3916	1	*1
2.1/16	82	86	30	135	4030	1	*1
2.1/8	84	86	30	135	4160	1	*1
2.3/16	85	86	33	135	4200	1	*1
2.1/4	87	86	33	135	4160	1	*1
2.3/8	91	86	35	135	4370	1	*1
2.7/16	93	86	35	135	4490	1	*1
2.1/2	96	86	35	135	4630	1	*1
2.9/16	97	86	38	145	5260	1	*1
2.5/8	100	86	38	145	5320	1	*1
2.11/16	101	86	38	145	5670	1	*1
2.3/4	103	86	40	145	5780	1	*1
2.13/16	105	86	40	145	6000	1	*1
2.7/8	106	86	40	145	6080	1	*1
2.15/16	108	86	42	155	6580	1	*1
3	108	86	42	155	6850	1	*1
3.1/8	115	86	46	165	7740	1	*1
3.3/4	135	127	55	175	12200	1	*2
3.7/8	140	127	56	175	11080	1	*2

\*1 C-Ring=1700C, Pin/O-Ring=1701A/B → P232-233  
\*2 Pin/O-Ring=1702A/B

HAND MANUALES  
Z-SERIES  
TITANIUM DE TITANIO  
ACCESSORIES ACCESORIOS  
SCREWDRIVERS DESTORNILLADORES  
IMPACT DE IMPACTO  
SLEEVE-DRIVE  
INDUSTRIAL INDUSTRIALES  
AUTOMOTIVE  
CONSTRUCTION CONSTRUCCION  
RENEWAL KITS JUEGOS DE PIZAS REPUESTO

# Impact Sockets 1-1/2"

HAND MANUALES  
Z-SERIES  
TITANIUM DE TITANIO  
ACCESSORIES ACCESORIOS  
SCREWDRIVERS DESTORNILLADORES  
IMPACT DE IMPACTO  
SLEEVE-DRIVE  
INDUSTRIAL INDUSTRIALES  
AUTOMOTIVE  
CONSTRUCTION CONSTRUCCION  
RENEWAL KITS JUEGOS DE PIEZAS REPLUESTO

## 17108 Bit Holder, For 107-32 Porta Punta

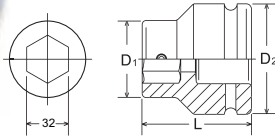

	D <sub>1</sub> (mm)	D <sub>2</sub> (mm)	L (mm)	(g)	(pce.)	
<b>17108</b>	60	86	85	2200	1	*1

\*1 C-Ring = 1700C, Pin/O-Ring = 1701A/B → P232-233

Replacement Screw : M8x14, ●4mm

## 107-32 Bit for Inhex Screws Puntas para Tornillos Inhex

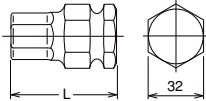

107.32 (mm)	L (mm)	(g)	(pce.)
<b>19</b>	60	300	10
<b>22</b>	60	320	10
<b>24</b>	60	330	10
<b>27</b>	60	360	10
<b>30</b>	60	390	10
<b>32</b>	60	410	10
<b>36</b>	60	460	10

## 17108-32 Hex Bit Sockets Vasos con Punta Hexagonal

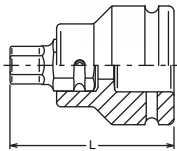

	17108-32 (mm)	L (mm)	(g)	(pce.)	
New	<b>19</b>	115	2500	1	*1
New	<b>22</b>	115	2520	1	*1
New	<b>24</b>	115	2530	1	*1
New	<b>27</b>	115	2560	1	*1
New	<b>30</b>	115	2590	1	*1
New	<b>32</b>	115	2610	1	*1
New	<b>36</b>	115	2660	1	*1

\*1 C-Ring=1700C, Pin/O-Ring=1701A/B → P232-233



# 1-1/2" Impact Sockets

17760	D (mm)	L (mm)	(g)	(pce.)	
175	86	175	3300	1	*1
250	86	250	4500	1	*1
330	86	330	5200	1	*1

\*1 C-Ring=1700C, Pin/O-Ring=1701A/B → P232-233

## 17760-175 • -250 • -330 Extension Bars Alargaderas



	L (mm)	(g)	(pce.)	
17770	200	4700	1	*1

\*1 C-Ring=1700C, Pin/O-Ring=1701A/B → P232-233

## 17770 Universal Joint Articulación Universal



17788A	(sq.)	(sq.)	L (mm)	(g)	(pce.)	
17788A	1.1/2"	1"	97	2600	1	*1

\*1 C-Ring=1700C, Pin/O-Ring=1701A/B → P232-233

**⚠** Adapting down from bigger square drive to smaller square drive may lead to excessive torque load and possibly cause breakage. Always stay within safe torque of the smaller square drive.

## 17788A ⚠ Adaptors Adaptadores No Warranty Sin Garantía



17799A	(sq.)	(sq.)	L (mm)	(g)	(pce.)	
17799A	1.1/2"	2.1/2"	115	3790	1	*1

\*1 C-Ring=1700C, Pin/O-Ring=1701A/B → P232-233

## 17799A Adaptors Adaptadores



HAND MANUALES  
Z-SERIES  
TITANIUM DE TITANIO  
ACCESSORIES ACCESORIOS  
SCREWDRIVERS DESTORNILLADORES  
IMPACT DE IMPACTO  
SLEEVE-DRIVE  
INDUSTRIAL INDUSTRIALES  
AUTOMOTIVE  
CONSTRUCTION CONSTRUCCION  
RENEWAL KITS JUEGOS DE PIEZAS REPIESTO

# Impact Sockets 2-1/2"

## 19400M • 19400A

6-point Sockets  
Vasos Hexagonales

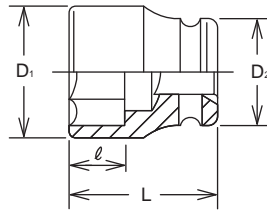

19400M (mm)	D <sub>1</sub> (mm)	D <sub>2</sub> (mm)	(mm)	L (mm)	(g)	(pce.)	Ⓟ
50	88	127	39	115	7270	1	*1
55	94	127	42	115	7350	1	*1
60	100	127	45	125	7870	1	*1
65	105	127	48	125	7790	1	*1
70	110	127	51	125	7640	1	*1
75	118	127	54	125	7740	1	*1
80	124	127	57	125	7640	1	*1
85	127	127	61	132	7840	1	*1
90	135	127	64	132	8500	1	*1
95	140	127	71	140	10160	1	*1
100	146	127	71	142	11500	1	*1
105	155	127	74	146	11350	1	*1
110	160	127	76	155	12710	1	*1
115	167	127	78	158	13980	1	*1
120	175	175	79	160	15430	1	*2
125	180	175	82	165	16590	1	*2
130	185	175	85	169	17590	1	*2
135	190	175	89	175	19030	1	*2
140	200	175	93	180	21810	1	*2
145	205	175	95	183	24440	1	*2
150	210	175	97	192	25720	1	*2
160	225	175	102	200	30920	1	*2
165	230	175	105	204	32610	1	*2
170	235	175	106	207	34390	1	*2
175	240	175	109	211	36210	1	*2
180	250	175	110	214	40630	1	*2
185	255	175	113	218	42690	1	*2
190	265	175	113	220	47440	1	*2
200	275	175	116	225	51550	1	*2
210	285	175	123	235	57170	1	*2
215	290	175	126	240	60260	1	*2
225	305	175	133	250	70180	1	*2
235	315	175	140	260	77060	1	*2

19400A (inch)	D <sub>1</sub> (mm)	D <sub>2</sub> (mm)	(mm)	L (mm)	(g)	(pce.)	Ⓟ
2. 3/8	100	127	45	125	7870	1	*1
2. 7/16	102	127	46	125	7840	1	*1
2. 1/2	103	127	47	125	7810	1	*1
2. 9/16	105	127	48	125	7790	1	*1
2. 5/8	107	127	49	125	7790	1	*1
2.11/16	108	127	50	125	7790	1	*1
2. 3/4	110	127	51	125	7640	1	*1
2.13/16	113	127	52	125	7690	1	*1
2. 7/8	115	127	53	125	7730	1	*1
2.15/16	118	127	54	125	7740	1	*1
3	120	127	55	125	7740	1	*1
3. 1/8	124	127	57	125	7640	1	*1
3. 1/4	125	127	59	125	7740	1	*1
3. 3/8	127	127	61	132	7840	1	*1
3. 1/2	135	127	64	132	8500	1	*1
3. 5/8	138	127	64	132	9330	1	*1
3. 3/4	140	127	71	140	10160	1	*1
3. 7/8	143	127	70	140	10830	1	*1
4	146	127	71	142	11500	1	*1
4. 1/8	155	127	70	142	11250	1	*1
4. 1/4	160	127	76	155	12710	1	*1
4. 1/2	167	127	78	158	13980	1	*1
4. 5/8	175	175	79	160	15430	1	*2
4. 7/8	180	175	82	165	16590	1	*2
5	183	175	81	165	17090	1	*2
5. 1/4	190	175	89	175	19030	1	*2
5. 3/8	198	175	94	180	20880	1	*2
5. 1/2	200	175	93	180	21810	1	*2
5. 5/8	203	175	94	182	22480	1	*2
5. 3/4	207	175	103	192	24440	1	*2
6	217	175	100	196	28510	1	*2
6. 1/8	218	175	99	196	29720	1	*2
6. 5/8	233	175	105	205	33500	1	*2
7	248	175	110	213	39160	1	*2

\*1 Pin/O-Ring=1901A/B

\*2 Pin/O-Ring=1902A/B

→ P233

# 2-1/2" Impact Sockets

19300M (mm)	D <sub>1</sub> (mm)	D <sub>2</sub> (mm)	(mm)	L (mm)	(g)	(pce.)	
75	118	127	42	190	11930	1	*1
80	124	127	46	190	12280	1	*1
85	127	127	49	195	12480	1	*1
90	135	127	52	205	14000	1	*1
95	140	127	55	210	14630	1	*1
100	146	127	58	215	15520	1	*1
105	155	127	62	220	18250	1	*1
110	160	127	65	225	18740	1	*1
115	167	127	68	230	20940	1	*1
120	175	175	72	235	23530	1	*2
125	180	175	74	238	26110	1	*2
130	185	175	76	243	25320	1	*2
135	190	175	80	248	26290	1	*2
140	200	175	82	248	28940	1	*2
145	205	175	84	248	29520	1	*2
150	210	175	88	255	30600	1	*2
155	215	175	92	255	31680	1	*2
160	225	175	95	260	35560	1	*2
165	230	175	98	260	36040	1	*2
170	235	175	100	265	37230	1	*2
175	240	175	102	270	39420	1	*2

\*1 Pin/O-Ring=1901A/B → P233  
 \*2 Pin/O-Ring=1902A/B

19760	D (mm)	L (mm)	(g)	(pce.)	
250	127	250	17800	1	*1
500	127	500	27800	1	*1

\*1 Pin/O-Ring=1901A/B → P233

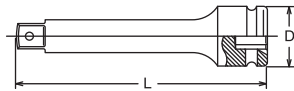

19770	L (mm)	(g)	(pce.)	
19770	303	21360	1	*1

\*1 Pin/O-Ring=1901A/B → P233

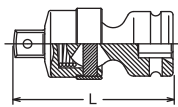

19977A	(sq.)	(sq.)	L (mm)	(g)	(pce.)	
19977A	2.1/2"	1.1/2"	144	7210	1	*1

\*1 Pin/O-Ring=1901A/B → P233

⚠ Adapting down from bigger square drive to smaller square drive may lead to excessive torque load and possibly cause breakage. Always stay within safe torque of the smaller square drive.

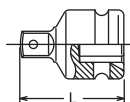

## 19300M 6-point Deep Sockets Vasos Hexagonales Largos

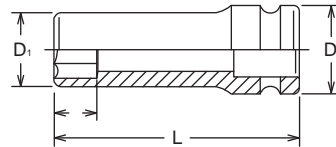

## 19760-250 · -500 Extension Bars Alargaderas



## 19770 Universal Joint Articulación Universal



## 19977A Adaptor Adaptador No Warranty Sin Garantía ⚠



HAND MANUALES  
 Z-SERIES  
 TITANIUM DE TITANIO  
 ACCESSORIES ACCESORIOS  
 SCREWDRIVERS DESTORNILLADORES  
 IMPACT DE IMPACTO  
 SLEEVE-DRIVE  
 INDUSTRIAL INDUSTRIALES  
 AUTOMOTIVE  
 CONSTRUCTION CONSTRUCCION  
 RENEWAL KITS JUEGOS DE PIEZAS REPIESTO



# Impact Sockets 3-1/2"

## 10400M • 10400A

6-point Sockets  
Vasos Hexagonales

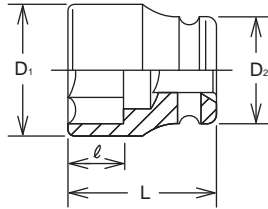

10400M (mm)	D <sub>1</sub> (mm)	D <sub>2</sub> (mm)	(mm)	L (mm)	(g)	(pce.)	⚡
105	165	175	86	176	19370	1	*1
110	170	175	88	179	20160	1	*1
115	175	175	90	183	21160	1	*1
120	180	175	91	185	21930	1	*1
125	188	175	94	190	23940	1	*1
130	193	175	97	194	25050	1	*1
135	200	175	101	199	26930	1	*1
140	205	175	105	205	28560	1	*1
145	210	200	106	207	29600	1	*2
150	215	200	109	212	31240	1	*2
160	228	200	114	220	35500	1	*2
165	235	200	117	224	37940	1	*2
170	240	200	118	227	39660	1	*2
175	245	200	121	231	41400	1	*2
180	255	200	122	234	45740	1	*2
185	265	200	125	238	50350	1	*2
190	275	200	125	239	54650	1	*2
200	285	200	128	245	59190	1	*2
210	295	200	135	255	64970	1	*2
215	300	200	138	260	68150	1	*2

10400A (inch)	D <sub>1</sub> (mm)	D <sub>2</sub> (mm)	(mm)	L (mm)	(g)	(pce.)	⚡
4.1/8	165	175	86	176	19370	1	*1
4.1/4	168	175	87	178	19770	1	*1
4.3/8	172	175	88	180	20660	1	*1
4.1/2	175	175	89	182	21160	1	*1
4.5/8	178	175	90	183	21550	1	*1
4.3/4	180	175	91	185	21930	1	*1
4.7/8	188	175	94	190	23940	1	*1
5	188	175	95	191	24500	1	*1
5.1/8	193	175	97	194	25050	1	*1
5.1/4	197	175	100	198	25990	1	*1
5.3/8	201	175	102	202	27750	1	*1
5.1/2	205	175	105	205	28560	1	*1
5.5/8	208	200	106	208	30110	1	*2
5.3/4	212	200	108	210	30610	1	*2
5.7/8	215	200	109	212	31240	1	*2
6	219	200	110	214	32460	1	*2
6.1/8	223	200	112	216	33670	1	*2
6.1/4	227	200	114	218	34590	1	*2
6.3/8	231	200	115	221	36720	1	*2
6.1/2	235	200	117	224	37940	1	*2
6.5/8	238	200	118	226	38800	1	*2
6.3/4	241	200	119	228	39870	1	*2
6.7/8	245	200	120	230	40640	1	*2
7	251	200	121	232	43570	1	*2
7.1/8	257	200	122	234	46450	1	*2
7.1/4	263	200	123	236	48400	1	*2
7.3/8	269	200	124	238	52500	1	*2
7.1/2	275	200	125	240	55350	1	*2
7.5/8	278	200	127	242	56050	1	*2
7.3/4	282	200	129	245	57620	1	*2
7.7/8	285	200	130	248	60870	1	*2
8	290	200	132	250	62550	1	*2
8.1/8	293	200	133	251	63760	1	*2
8.1/4	295	200	135	255	64970	1	*2
8.3/8	298	200	136	258	65580	1	*2
8.1/2	300	200	138	260	68150	1	*2
8.5/8	305	200	139	262	70760	1	*2
8.3/4	310	200	140	264	73830	1	*2
8.7/8	313	200	142	267	75780	1	*2

\*1 Pin/O-Ring=2001A/B → P233  
\*2 Pin/O-Ring=2002A/B

## 10099A

Adaptor  
Adaptador No Warranty  
Sin Garantía ⚠



10099A	(sq.)	(sq.)	L (mm)	(g)	(pce.)	⚡
10099A	3.1/2"	2.1/2"	182	16870	1	*1

\*1 Pin/O-Ring=2001A/B → P233

⚠ Adapting down from bigger square drive to smaller square drive may lead to excessive torque load and possibly cause breakage. Always stay within safe torque of the smaller square drive.

3/8"

1/2"

3/4"

# Sleeve Drive Sockets



HAND  
MANUALES

Z-SERIES

TITANIUM  
DE TITANIO

ACCESSORIES  
ACCESORIOS

SCREWDRIVERS  
DESTORNILLADORES

IMPACT  
DE IMPACTO

SLEEVE-DRIVE

INDUSTRIAL  
INDUSTRIALES

AUTOMOTIVE

CONSTRUCTION  
CONSTRUCCIÓN

RENEWAL KITS  
JUEGOS DE PIEZAS REPLUSTO



The deepened drive end of the **Sleeve-Drive** tools prevents the sometimes "wobbly" connection between pulse tool - extension - socket. An O-ring inside **Sleeve-Drive** optimizes the perfect fit of extension bars and sockets on the anvil to the effect, that the exactness of the required torque given by the pulse tool is generally improved. Further, the **Sleeve-Drive** avoids the direct transmission of vibrations on the pulse tool and finally on the operator.

El extremo de accionamiento alargado de las herramientas con **casquillo conductor** evita la unión a veces "holgada" entre la herramienta de percusión-alargadera-vaso. Una junta tórica en el interior del **casquillo conductor** optimiza el ajuste perfecto de las alargaderas y los vasos en el elemento de accionamiento lo que se traduce en la mejora de la exactitud del par requerido suministrado por la herramienta de percusión.

Sleeve Drive Sockets

Wrenches

O-Ring

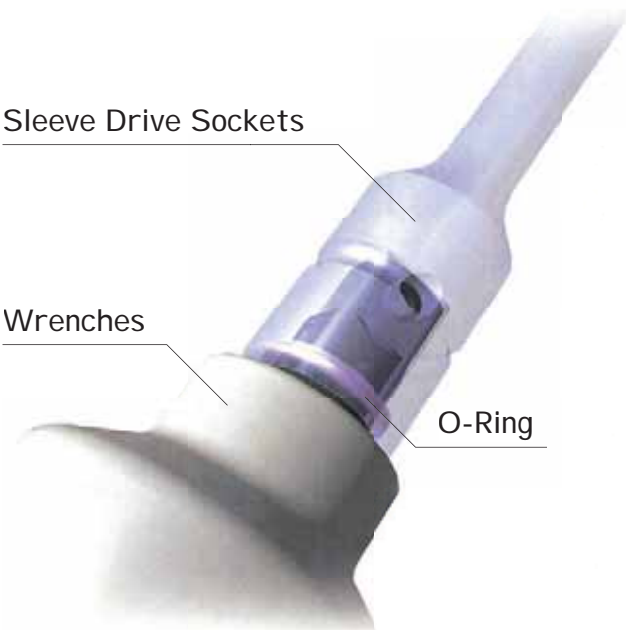

SLEEVE DRIVE SOCKET

PULSE TOOL

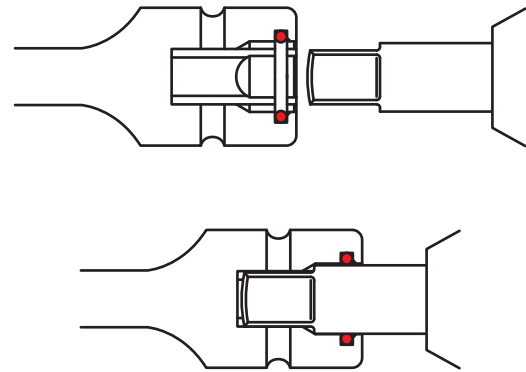

The "**Sleeve Drive**" Sockets and accessories are designed for use on Pulse Tools with anvils of certain lengths and diameters as shown hereunder.

Los Vasos y accesorios con Casquillo Conductor se han diseñado para su utilización con Herramientas de Percusión con elementos de accionamiento de cierta longitud y diámetro como se muestra a continuación.

	Anvil Diameter (mm)	Minimum Anvil Length (mm)
3/8"sq.	12	10
1/2"sq.	16	10
3/4"sq.	25	11.8

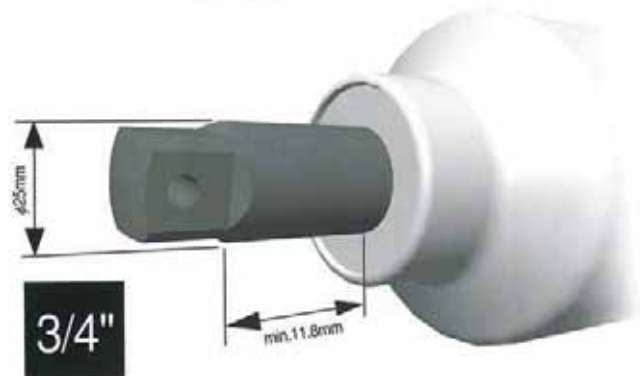
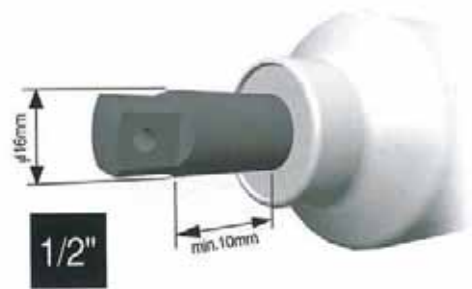

# 3/8" Sleeve Drive Sockets

NV13400 (mm)	D <sub>1</sub> (mm)	D <sub>2</sub> (mm)	(mm)	L (mm)	(g)	(pcs.)	⚡
10	15.8	19	7	43	53	10	*1
11	17	19	8	43	54	10	*1
12	18.3	19	9	43	55	10	*1
13	19.5	22	10	43	80	10	*2
14	20.8	22	10	43	80	10	*2
15	22	22	11	43	81	10	*2
16	23.3	22	11	43	83	10	*2
17	24.5	22	11	43	85	10	*2
18	25.8	22	11	43	89	10	*2
19	27	22	11	43	98	10	*2
21	29.5	22	11	43	105	10	*2
22	30.8	22	11	43	112	10	*2

\*1 C-Ring=1301C, Pin/O-Ring=1301A/B  
 \*2 C-Ring=1302C, Pin/O-Ring=1302A/B

➔ P232-233

## NV13400 6-point Sockets Vasos Hexagonales

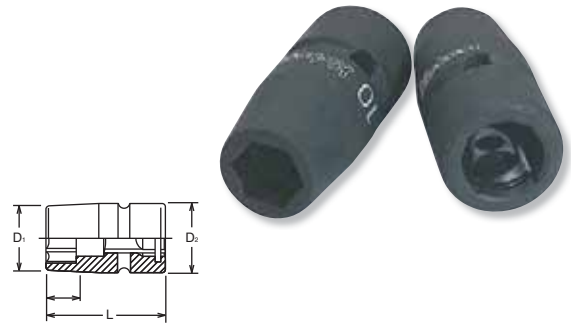

NV13145.100 (mm)	D <sub>1</sub> (mm)	D <sub>2</sub> (mm)	(mm)	L (mm)	(g)	(pcs.)	⚡
6	13	19	6	100	108	10	*1
8	13	19	8	100	110	10	*1
10	15.5	19	10	100	112	10	*1
12	18	19	12	100	120	10	*1
13	19	19	13	100	127	10	*1
14	21	19	14	100	131	10	*1
15	22	19	15	100	133	10	*1
16	24	19	15	100	144	10	*1
17	25	19	15	100	154	10	*1

NV13145.150 (mm)	D <sub>1</sub> (mm)	D <sub>2</sub> (mm)	(mm)	L (mm)	(g)	(pcs.)	⚡
6	13	19	6	150	163	10	*1
8	13	19	8	150	158	10	*1
10	15.5	19	10	150	165	10	*1
12	18	19	12	150	168	10	*1
13	19	19	13	150	170	10	*1
14	21	19	14	150	175	10	*1
15	22	19	15	150	177	10	*1
16	24	19	15	150	190	10	*1
17	25	19	15	150	203	10	*1

NV13145.200 (mm)	D <sub>1</sub> (mm)	D <sub>2</sub> (mm)	(mm)	L (mm)	(g)	(pcs.)	⚡
6	13	19	6	200	209	10	*1
8	13	19	8	200	203	10	*1
10	15.5	19	10	200	212	10	*1
12	18	19	12	200	214	10	*1
13	19	19	13	200	218	10	*1
14	21	19	14	200	220	10	*1
15	22	19	15	200	226	10	*1
16	24	19	15	200	235	10	*1
17	25	19	15	200	250	10	*1

\*1 C-Ring=1301C, Pin/O-Ring=1301A/B

➔ P232-233

## NV13145-100 • -150 • -200 Extended Sockets Vasos con Alargadera

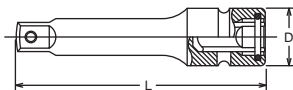
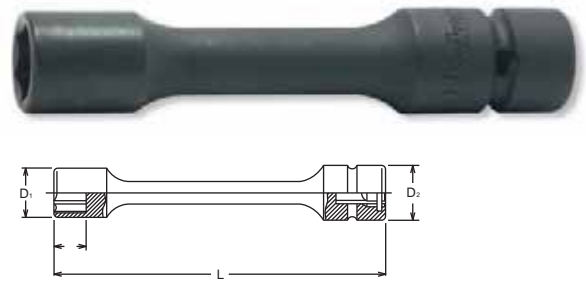

## NV13760-75P • -125P • -150P • -250P

Extension Bars Alargaderas



NV13760	D (mm)	L (mm)	(g)	(pcs.)	⚡
75P	19	75	95	10	*1
125P	19	125	125	10	*1
150P	19	150	150	10	*1
250P	19	250	255	10	*1

\*1 C-Ring=1301C, Pin/O-Ring=1301A/B

➔ P232-233

HAND MANUALES  
 Z-SERIES  
 TITANIUM DE TITANIO  
 ACCESSORIES ACCESORIOS  
 SCREWDRIVERS DESTORNILLADORES  
 IMPACT DE IMPACTO  
 SLEEVE-DRIVE INDUSTRIAL INDUSTRIALES  
 AUTOMOTIVE  
 CONSTRUCTION CONSTRUCCION  
 RENEWAL KITS JUEGOS DE PIEZAS REPUESTO

# Sleeve Drive Sockets **3/8"**

HAND MANUALES  
Z-SERIES  
TITANIUM DE TITANIO  
ACCESSORIES ACCESORIOS  
SCREWDRIVERS DESTORNILLADORES  
IMPACT DE IMPACTO  
SLEEVE-DRIVE  
INDUSTRIAL INDUSTRIALES  
AUTOMOTIVE  
CONSTRUCTION CONSTRUCCION  
RENEWAL KITS JUEGOS DE PIEZAS REPLÉSTO

## NV13105 Bit Holder Porta Punta

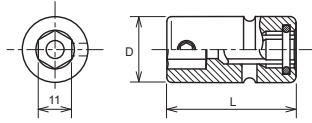

NV13105	D (mm)	L (mm)	(g)	(pcs.)	
	22	43	90	5	*1

\*1 C-Ring=1301C, Pin/O-Ring=1301A/B → P232-233

 Replacement Screw : M5x6, ●2.5mm

## 107-11 Bits for Inhex Screws Puntas para Tornillos de Seis Lados en el Interior (Inhex)

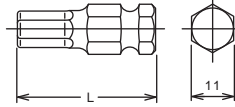

107-11 (inch)	L (mm)	(g)	(pcs.)
3/16	35	15	10
7/32	35	16	10
1/4	35	18	10
5/16	35	20	10
3/8	35	26	10
7/16	35	28	10
1/2	35	38	10
5/8	35	47	10
3/4	35	56	10

107-11 (mm)	L (mm)	(g)	(pcs.)
3	35	15	10
4	35	16	10
5	35	16	10
6	35	18	10
7	35	19	10
8	35	20	10
10	35	26	10
11	35	28	10
12	35	31	10
14	35	38	10
16	35	47	10
17	35	50	10
18	35	53	10
19	35	56	10

107-11 (L80) (mm)	L (mm)	(g)	(pcs.)
4	80	54	10
5	80	54	10
6	80	56	10
7	80	57	10
8	80	59	10
10	80	64	10
11	80	66	10
12	80	76	10
14	80	98	10

## 107-11 (T) TORX® Bits Puntas TORX®

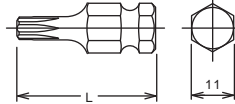

107-11 (T)	L (mm)	(g)	(pcs.)
T25	35	18	10
T30	35	18	10
T40	35	20	10
T45	35	22	10
T50	35	26	10
T55	35	31	10
T60	35	38	10

107-11 (L80) (T)	L (mm)	(g)	(pcs.)
T30	80	54	10
T40	80	54	10
T45	80	56	10
T50	80	57	10
T55	80	66	10
T60	80	76	10

## 107-11 (XZN) Bits XZN Puntas XZN

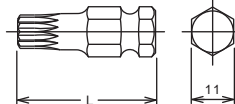

107-11 (XZN)	L (mm)	(g)	(pcs.)
M 4	35	18	10
M 5	35	20	10
M 6	35	22	10
M 8	35	26	10
M10	35	31	10
M12	35	38	10

107-11 (L80) (XZN)	L (mm)	(g)	(pcs.)
M 4	80	54	10
M 5	80	54	10
M 6	80	56	10
M 8	80	57	10
M10	80	66	10
M12	80	76	10
M14	80	80	10



# 1/2" Sleeve Drive Sockets

NV14400 (mm)	D <sub>1</sub> (mm)	D <sub>2</sub> (mm)	(mm)	L (mm)	(g)	(pcs.)	
12	19.5	25	9	54	120	10	*1
13	20.7	25	10	54	120	10	*1
14	22	25	10	54	120	10	*1
15	23.2	30	11	54	188	10	*2
16	24.5	30	11	54	189	10	*2
17	25.7	30	12	54	190	10	*2
18	27	30	12	54	190	10	*2
19	28.2	30	12	54	190	10	*2
21	30.7	30	12	54	191	10	*2
22	32	30	12	54	192	10	*2
23	33.2	30	12	54	196	10	*2
24	34.5	30	12	54	200	10	*2

\*1 C-Ring=1401C, Pin/O-Ring=1401A/B  
 \*2 C-Ring=1402C, Pin/O-Ring=1402A/B → P232-233

NV14145.100 (mm)	D <sub>1</sub> (mm)	D <sub>2</sub> (mm)	(mm)	L (mm)	(g)	(pcs.)	
10	15.5	25	10	100	161	10	*1
12	18	25	12	100	178	10	*1
13	19	25	13	100	175	10	*1
14	21	25	14	100	181	10	*1
15	22	25	15	100	185	10	*1
16	24	25	15	100	193	10	*1
17	25	25	15	100	201	10	*1
18	26	25	15	100	211	10	*1
19	28	25	15	100	221	10	*1

NV14145.150 (mm)	D <sub>1</sub> (mm)	D <sub>2</sub> (mm)	(mm)	L (mm)	(g)	(pcs.)	
10	15.5	25	10	150	200	10	*1
12	18	25	12	150	215	10	*1
13	19	25	13	150	220	10	*1
14	21	25	14	150	225	10	*1
15	22	25	15	150	230	10	*1
16	24	25	15	150	240	10	*1
17	25	25	15	150	250	10	*1
18	26	25	15	150	262	10	*1
19	28	25	15	150	275	10	*1

## NV14400 6-point Sockets Vasos Hexagonales



## NV14145-100 • -150 • -200 Extended Sockets Vasos con Alargadera

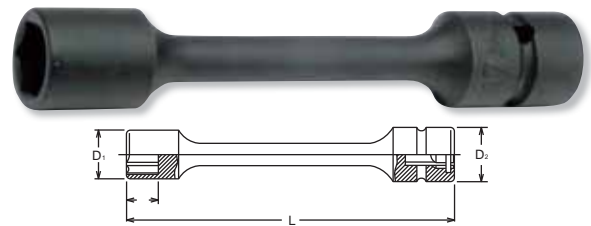

NV14145.200 (mm)	D <sub>1</sub> (mm)	D <sub>2</sub> (mm)	(mm)	L (mm)	(g)	(pcs.)	
10	15.5	25	10	200	236	10	*1
12	18	25	12	200	250	10	*1
13	19	25	13	200	260	10	*1
14	21	25	14	200	270	10	*1
15	22	25	15	200	275	10	*1
16	24	25	15	200	287	10	*1
17	25	25	15	200	300	10	*1
18	26	25	15	200	310	10	*1
19	28	25	15	200	320	10	*1

\*1 C-Ring=1401C, Pin/O-Ring=1401A/B → P232-233

## NV14760-75P • -125P • -175P • -250P Extension Bars Alargaderas

NV14760	D (mm)	L (mm)	(g)	(pcs.)	
75P	25	75	149	10	*1
125P	25	125	230	10	*1
175P	25	175	308	10	*1
250P	25	250	422	10	*1

\*1 C-Ring=1401C, Pin/O-Ring=1401A/B → P232-233

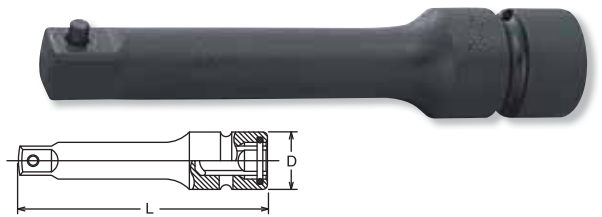

## NV14433A-75P • -100P • -150P

Adaptors No Warranty   
 Adaptadores Sin Garantía

NV14433A	(mm)	(mm)	L (mm)	(g)	(pce.)	
75P	1/2"	3/8"	75	120	1	*1
100P	1/2"	3/8"	100	145	1	*1
150P	1/2"	3/8"	150	187	1	*1

\*1 C-Ring=1401C, Pin/O-Ring=1401A/B → P232-233

 Adapting down from bigger square drive to smaller square drive may lead to excessive torque load and possibly cause breakage. Always stay within safe torque of the smaller square drive.

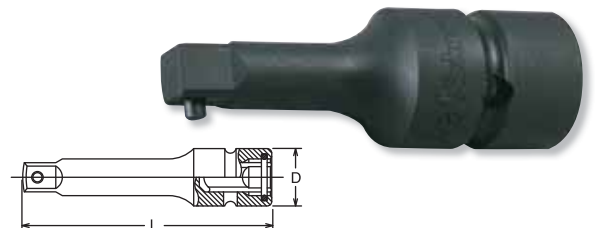

HAND MANUALES  
 Z-SERIES  
 TITANIUM DE TITANIO  
 ACCESSORIES ACCESORIOS  
 SCREWDRIVERS DESTORNILLADORES  
 IMPACT DE IMPACTO  
 SLEEVE-DRIVE  
 INDUSTRIAL INDUSTRIALES  
 AUTOMOTIVE  
 CONSTRUCTION CONSTRUCCION  
 RENEWAL KITS JUEGOS DE PIEZAS REPUESTO

# Sleeve Drive Sockets 1/2"

HAND MANUALES  
Z-SERIES  
TITANIUM DE TITANIO  
ACCESSORIES ACCESORIOS  
SCREWDRIVERS DESTORNILLADORES  
IMPACT DE IMPACTO  
SLEEVE-DRIVE  
INDUSTRIAL INDUSTRIALES  
AUTOMOTIVE  
CONSTRUCTION CONSTRUCCION  
RENEWAL KITS JUEGOS DE PIEZAS REPLÉSTO

## NV14105 Bit Holder Porta Punta

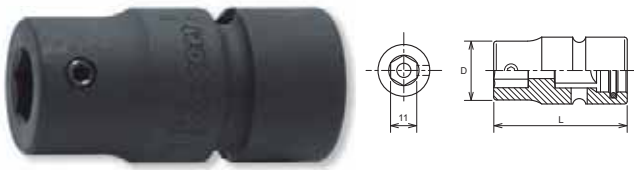

NV14105	D (mm)	L (mm)	(g)	(pcs.)	
	22	43	115	5	*1

\*1 C-Ring=1401C, Pin/O-Ring=1401A/B → P232-233

 Replacement Screw : M5x6, ●2.5mm

## 107-11 Bits for Inhex Screws Puntas para Tornillos de Seis Lados en el Interior (Inhex)

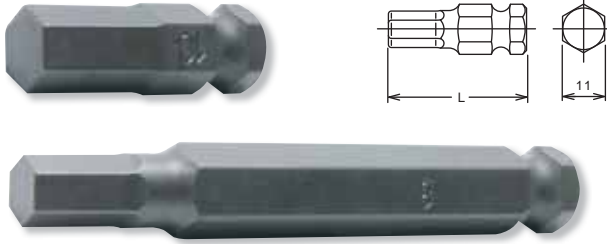

107-11 (inch)	L (mm)	(g)	(pcs.)
3/16	35	15	10
7/32	35	16	10
1/4	35	18	10
5/16	35	20	10
3/8	35	26	10
7/16	35	28	10
1/2	35	38	10
5/8	35	47	10
3/4	35	56	10

107-11 (mm)	L (mm)	(g)	(pcs.)
3	35	15	10
4	35	16	10
5	35	16	10
6	35	18	10
7	35	19	10
8	35	20	10
10	35	26	10
11	35	28	10
12	35	31	10
14	35	38	10
16	35	47	10
17	35	50	10
18	35	53	10
19	35	56	10

107-11 (L80) (mm)	L (mm)	(g)	(pcs.)
4	80	54	10
5	80	54	10
6	80	56	10
7	80	57	10
8	80	59	10
10	80	64	10
11	80	66	10
12	80	76	10
14	80	98	10

## 107-11 (T) TORX® Bits Puntas TORX®

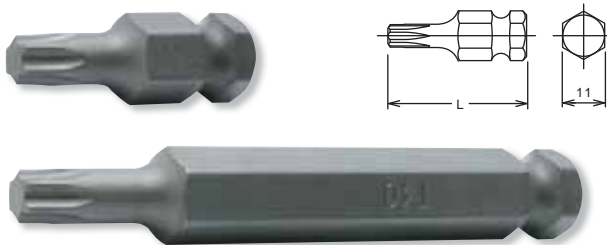

107-11 (T)	L (mm)	(g)	(pcs.)
T25	35	18	10
T30	35	18	10
T40	35	20	10
T45	35	22	10
T50	35	26	10
T55	35	31	10
T60	35	38	10

107-11 (L80) (T)	L (mm)	(g)	(pcs.)
T30	80	54	10
T40	80	54	10
T45	80	56	10
T50	80	57	10
T55	80	66	10
T60	80	76	10

## 107-11 (XZN) Bits XZN Puntas XZN

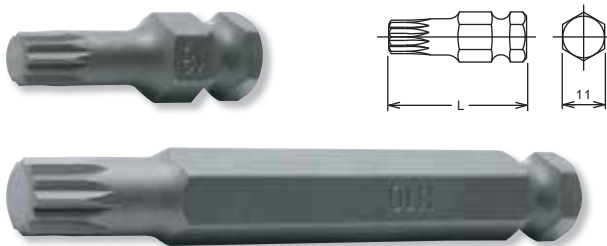

107-11 (XZN)	L (mm)	(g)	(pcs.)
M 4	35	18	10
M 5	35	20	10
M 6	35	22	10
M 8	35	26	10
M10	35	31	10
M12	35	38	10

107-11 (L80) (XZN)	L (mm)	(g)	(pcs.)
M 4	80	54	10
M 5	80	54	10
M 6	80	56	10
M 8	80	57	10
M10	80	66	10
M12	80	76	10
M14	80	80	10

# 3/4" Sleeve Drive Sockets

NV16400 (mm)	D <sub>1</sub> (mm)	D <sub>2</sub> (mm)	(mm)	L (mm)	(g)	(pcs.)	⚡
17	30	44	12	65	448	5	*1
18	31.3	44	13	65	470	5	*1
19	32.5	44	13	65	455	5	*1
21	35	44	15	65	472	5	*1
22	36.3	44	16	65	471	5	*1
23	37.5	44	16	65	471	5	*1
24	38.8	44	16	65	467	5	*1
26	41.3	44	16	65	477	5	*1
27	42.5	44	16	65	473	5	*1
28	43.8	44	16	68	483	5	*1
29	45	44	18	68	464	5	*1
30	46.3	44	18	68	492	5	*1
32	48.8	44	19	70	514	5	*1
33	50	44	20	70	564	5	*1
34	51.3	44	20	70	588	5	*1
35	52.5	44	20	70	593	5	*1
36	53.8	44	20	70	598	5	*1
38	56.3	44	20	72	670	2	*1
41	60	44	22	72	687	2	*1
46	66.3	44	23	77	906	2	*1
50	69	44	23	77	1116	2	*1

\*1 C-Ring=1600C, Pin/O-Ring=1601A/B → P232-233

## NV16400 6-point Sockets Vasos Hexagonales

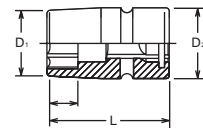

## NV16760-175 • -250 • -330 Extension Bars Alargaderas

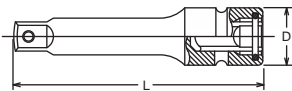

NV16760	D (mm)	L (mm)	(g)	(pce.)	⚡
175	44	175	870	1	*1
250	44	250	1160	1	*1
330	44	330	1460	1	*1

\*1 C-Ring=1600C, Pin/O-Ring=1601A/B → P232-233

HAND MANUALES  
Z-SERIES  
TITANIUM DE TITANIO  
ACCESSORIES ACCESORIOS  
SCREWDRIVERS DESTORNILLADORES  
IMPACT DE IMPACTO  
SLEEVE-DRIVE  
INDUSTRIAL INDUSTRIALES  
AUTOMOTIVE  
CONSTRUCTION CONSTRUCCION  
RENEWAL KITS JUEGOS DE PIEZAS REPIESTO

# C-Ring Lock Clamps and Pullers

## Aro de Sujeción en C y Extractor

HAND  
MANUALES

Z-SERIES

TITANIUM  
DE TITANIO

ACCESSORIES  
ACCESORIOS

SCREWDRIVERS  
DESTORNILLADORES

IMPACT  
DE IMPACTO

SLEEVE-DRIVE

INDUSTRIAL  
INDUSTRIALES

AUTOMOTIVE

CONSTRUCTION  
CONSTRUCCIÓN

RENEWAL KITS  
JUEGOS DE PIEZAS/REPLUSTO



One Piece solid springs steel ring. Simply set by finger pushing and easily removed by puller. Much more convenient and safer than combination of pin and o-ring.

Aro de acero elástico de una pieza. Colocación sencilla apretando con el dedo y fácilmente extraíble con el extractor. Mucho más cómodo y seguro que la combinación de pasador y junta tórica.

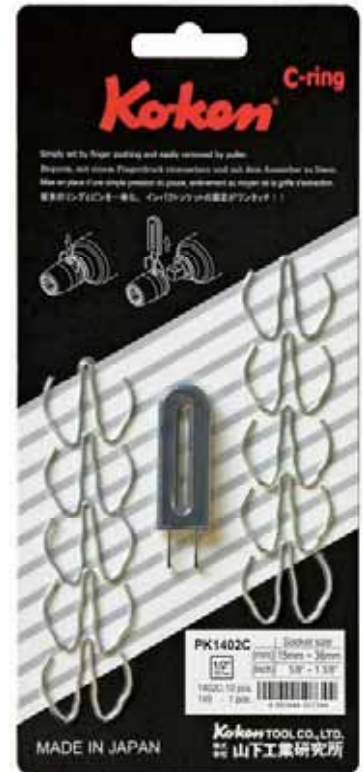

### C-Ring

No.	Opening (mm)	(pcs.)
1301C	3/8"	12
1302C	3/8"	> 12
1401C	1/2"	14
1402C	1/2"	> 14
1600C	3/4"	46
1801C	1"	70
1802C	1"	> 70
1700C	1-1/2"	90

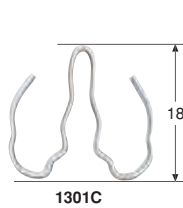

1301C

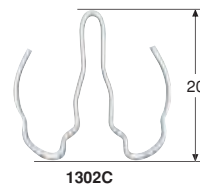

1302C

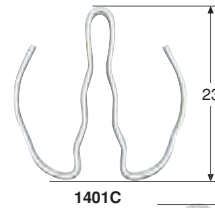

1401C

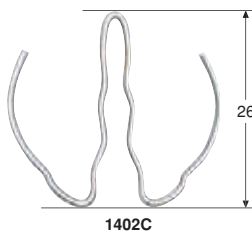

1402C

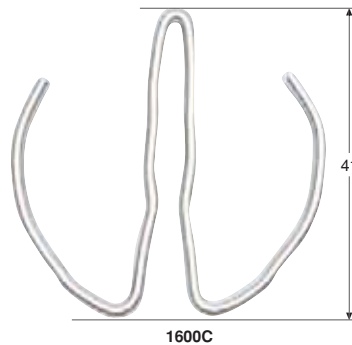

1600C

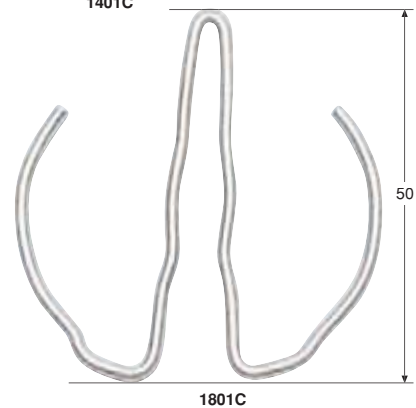

1801C

### C-Ring Set

Set No.	C-Ring 10pcs.	Puller 1pce.
PK1301C	1301C + 149	
PK1302C	1302C + 149	
PK1401C	1401C + 149	
PK1402C	1402C + 149	
PK1600C	1600C + 152	
PK1801C	1801C + 152	

### Puller

No.	Opening (mm)	(pcs.)
149	3/8"	10
152	3/4"	10

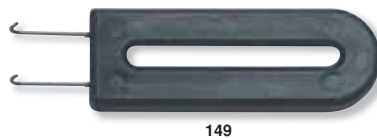

149



152

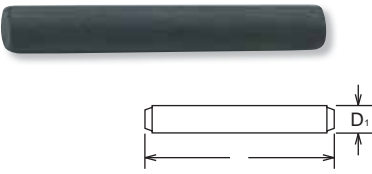

### Pin

No.	□	Opening (mm)	D <sub>1</sub> (mm)	(mm)	(pcs.)
1200A	1/4"		1.5	10.2	100
1301A	3/8"	12	2.5	14.5	100
1302A	3/8"	> 12	2.5	17.5	100
1401A	1/2"	14	3.5	20	100
1402A	1/2"	> 14	3.5	25	100
1500A	5/8"		4	30	100
1601A	3/4"	46	5.5	35	100
1602A	3/4"	> 46	5.5	45	100
1801A	1"	70	6	45	100
1802A	1"	> 70	6	75	50
1701A	1-1/2"	90	7	75	50
1702A	1-1/2"	> 90	7	110	50
1901A	2-1/2"	115	9	110	50
1902A	2-1/2"	> 115	9	155	50
2001A	3-1/2"	140	13	155	1
2002A	3-1/2"	> 140	13	180	1



### O-Ring

No.	□	Opening (mm)	D <sub>2</sub> (mm)	D <sub>3</sub> (mm)	(pcs.)
1200B	1/4"		2.5	9	100
1301B	3/8"	12	3.5	13	100
1302B	3/8"	> 12	3.5	16	100
1401B	1/2"	14	4	19	100
1402B	1/2"	> 14	4	24	100
1500B	5/8"		4.5	28	100
1601B	3/4"	46	5	36	100
1602B	3/4"	> 46	5	45	100
1801B	1"	70	7	45	100
1802B	1"	> 70	7	75	50
1701B	1-1/2"	90	10	75	50
1702B	1-1/2"	> 90	10	114	50
1901B	2-1/2"	115	10.5	114	50
1902B	2-1/2"	> 115	10.5	158	50
2001B	3-1/2"	140	15	158	1
2002B	3-1/2"	> 140	15	183	1



HAND MANUALES Z-SERIES TITANIUM DE TITANIO ACCESSORIES ACCESORIOS SCREWDRIVERS DESTORNILLADORES DE IMPACTO SLEEVE-DRIVE INDUSTRIAL INDUSTRIALES AUTOMOTIVE CONSTRUCTION CONSTRUCCION RENEWAL KITS JUEGOS DE PIEZAS REPIESTO



Pins & O Rings/C-Ring Lock Clamps  
Pasadores y Juntas Tóricas/Aros de Sujeción en C

IMPACT Standard Sockets size	Sq. Dr.	1/4"	3/8"		1/2"		3/4"		1"		1-1/2"	
	C-Ring		1301C	1302C	1401C	1402C	1600C	1801C	1801C	1802C	1700C	
	O-Ring/Pin	1200A/B	1301A/B	1302A/B	1401A/B	1402A/B	1601A/B	1602A/B	1801A/B	1802A/B	1701A/B	1702A/B
4												
4.5	3/16											
5												
5.5												
6	1/4											
7	9/32											
8	5/16											
9	11/32											
10	3/8											
11	7/16											
12												
13	1/2											
14	9/16											
15												
16	5/8											
17	11/16											
18												
19	3/4											
20												
21	13/16											
22	7/8											
23												
24	15/16											
25	1											
26												
27	1- 1/16											
28												
29	1- 1/8											
30	1- 3/16											
31												
32	1- 1/4											
33	1- 5/16											
34	1- 3/8											
36												
37	1- 7/16											
38	1- 1/2											
39												
40	1- 9/16											
41	1- 5/8											
42												
43	1- 11/16											
44												
45	1- 3/4											
46	1- 13/16											
47												
48	1- 7/8											
	1- 15/16											
50												
	2											
52	2- 1/16											
54	2- 1/8											
55	2- 3/16											
56												
	2- 1/4											
58	2- 5/16											
60	2- 3/8											
62	2- 7/16											
63												
	2- 1/2											
65	2- 9/16											
67	2- 5/8											
68	2- 11/16											
70	2- 3/4											
	2- 13/16											
	2- 7/8											
75	2- 15/16											
	3											
	3- 1/16											
80	3- 1/8											
	3- 1/4											
85												
	3- 3/8											
90	3- 1/2											
	3- 5/8											
95	3- 3/4											
100	3- 7/8											
105	4											
	4- 1/8											
110	4- 1/4											
115	4- 1/2											
120	4- 5/8											
	4- 3/4											
125	4- 7/8											
130	5											
135	5- 1/4											
140												
150												
	6											
	6- 1/2											



# INDUSTRIAL Sockets

1/4"

3/8"

1/2"



# Industrial Sockets 1/4"

HAND MANUALES  
Z-SERIES  
TITANIUM DE TITANIO  
ACCESSORIES ACCESORIOS  
SCREWDRIVERS DESTORNILLADORES  
IMPACT DE IMPACTO  
SLEEVE-DRIVE  
INDUSTRIAL INDUSTRIALES  
AUTOMOTIVE  
CONSTRUCTION CONSTRUCCION  
RENEWAL KITS JUEGOS DE PIEZAS/REPLUESTO

## 22400M 6-point Sockets Vasos Hexagonales

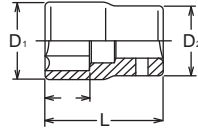

22400M (mm)	D <sub>1</sub> (mm)	D <sub>2</sub> (mm)	(mm)	L (mm)	(g)	(pcs.)
6	9.2	11.2	5.5	22	9	10
7	10.3	11.2	6	22	9	10
8	11.2	11.7	6.9	22	11	10
10	14.3	12.9	7.7	22	15	10
12	16.8	15.5	9.3	22	23	10
13	18	16.4	9.8	22	23	10

## 22425 TORX® Sockets Vasos TORX®

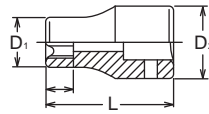

22425 (E)	D <sub>1</sub> (mm)	D <sub>2</sub> (mm)	(mm)	L (mm)	(g)	(pcs.)
E 4	5.4	11.2	4.6	22	7	10
E 5	6.7	11.2	5.2	22	8	10
E 6	7.7	11.2	5.4	22	8	10
E 7	8.3	11.2	6.6	22	9	10
E 8	9.6	11.2	7	22	9	10
E10	11.3	12	8.2	22	10	10

### TORX® (E)

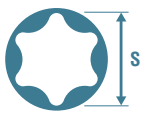

E	E4	E5	E6	E7	E8	E10	E11	E12	E14	E16	E18	E20	E22	E24	E26	E28
S (ref. mm)	3.83	4.72	5.69	6.17	7.47	9.37	10.03	11.12	12.85	14.71	16.64	18.41	20.24	22.10	23.85	25.65

## 22300M · 22300A 6-point Sockets, deep Vasos Hexagonales, largos

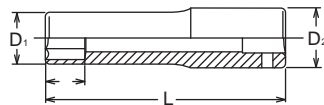

22300M (mm)	D <sub>1</sub> (mm)	D <sub>2</sub> (mm)	(mm)	L (mm)	(g)	(pcs.)
7	10.3	11.2	8	50	24	10
8	11.2	11.7	9	50	28	10
10	14.3	12.9	11	50	33	10
12	16.8	15.5	13	50	50	10
13	18	16.4	14	50	50	10

22300A (inch)	D <sub>1</sub> (mm)	D <sub>2</sub> (mm)	(mm)	L (mm)	(g)	(pcs.)
1/4	9.6	11.2	7	50	24	10
5/16	11.2	11.7	9	50	28	10
3/8	13.7	12.5	11	50	33	10



INDUSTRIAL sockets are thin walled sockets and to be used on electric or pneumatic nut runners for assembly work only.

Los vasos INDUSTRIALES son vasos de pared delgada para su utilización con herramientas eléctricas o neumáticas solamente para trabajos de montaje.

23400M (mm)	D <sub>1</sub> (mm)	D <sub>2</sub> (mm)	(mm)	L (mm)	(g)	(pcs.)
New 6	9.9	17.3	6	26	20	10
New 7	10.8	17.3	6.5	26	20	10
8	12	17.3	6.9	26	22	10
10	14.5	17.3	8	26	24	10
11	15.8	17.3	9.3	26	25	10
12	16.8	17.3	9	26	25	10
13	18	17	9.4	26	24	10
14	19.5	18.5	11	27	31	10
15	21	19.5	11.5	28	39	10
16	22	20	12	28	42	10
17	23.5	21.5	12.5	29	51	10
18	24.6	22.5	13	30	51	10
19	26	23.5	13.5	30	53	10
New 21	28	26	14.5	32	77	10

23400A (inch)	D <sub>1</sub> (mm)	D <sub>2</sub> (mm)	(mm)	L (mm)	(g)	(pcs.)
5/16	12	17.3	6.9	26	22	10
3/8	13.9	17.3	8	26	22	10
7/16	15.8	17.3	9.3	26	25	10
1/2	18	17	9.4	26	24	10
9/16	19.5	18.5	11	27	31	10
11/16	24.6	22.5	13	30	51	10
3/4	26	23.5	13.5	30	63	10

23405M (mm)	D <sub>1</sub> (mm)	D <sub>2</sub> (mm)	(mm)	L (mm)	(g)	(pcs.)
New 8	12	17.3	6.9	26	22	10
New 10	14.5	17.3	8	26	24	10
New 12	16.8	17.3	9	26	25	10
New 14	19.5	18.5	11	27	31	10

23410M (mm)	D <sub>1</sub> (mm)	D <sub>2</sub> (mm)	(mm)	L (mm)	(g)	(pcs.)
New 8	12	17.3	6.9	26	22	10
New 10	14.5	17.3	8	26	24	10
New 12	16.8	17.3	9	26	25	10
New 13	18	17	9.4	26	24	10
New 14	19.5	18.5	11	27	31	10
New 15	21	19.5	11.5	28	39	10
New 16	22	20	12	28	42	10
New 17	23.5	21.5	12.5	29	51	10
New 18	24.6	22.5	13	30	51	10
New 19	26	23.5	13.5	30	53	10

23425 (E)	D <sub>1</sub> (mm)	D <sub>2</sub> (mm)	(mm)	L (mm)	(g)	(pcs.)
E 5	7	17.3	5.2	26	20	10
E 6	8.3	17.3	5.4	26	21	10
E 7	8.9	17.3	6.6	26	22	10
E 8	9.9	17.3	7	26	23	10
E10	12	17.3	8.2	26	24	10
E11	13.3	17.3	8.7	26	25	10
E12	14.5	17.3	9.3	26	26	10
E14	15.8	17.3	10.6	26	27	10
E16	18	17	11.8	26	27	10

TORX® (E)



E	E4	E5	E6	E7	E8	E10	E11	E12	E14	E16	E18	E20	E22	E24	E26	E28
S (ref. mm)	3.83	4.72	5.69	6.17	7.47	9.37	10.03	11.12	12.85	14.71	16.64	18.41	20.24	22.10	23.85	25.65

## 23400M • 23400A 6-point Sockets Vasos Hexagonales

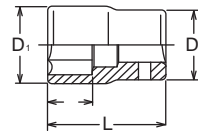

## 23405M 12-point Sockets Vasos Bihexagonales

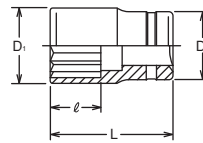

## 23410M Surface Drive Sockets Vasos Surface Drive (de Contacto Curvo)

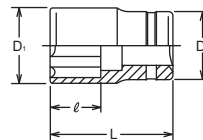

## 23425 TORX® Sockets Vasos TORX®

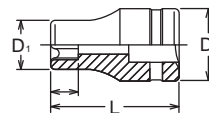

HAND MANUALES  
Z-SERIES  
TITANIUM DE TITANIO  
ACCESSORIES ACCESORIOS  
SCREWDRIVERS DESTORNILLADORES  
IMPACT DE IMPACTO  
SLEEVE-DRIVE INDUSTRIAL INDUSTRIALES  
AUTOMOTIVE  
CONSTRUCTION CONSTRUCCION  
RENEWAL KITS JUEGOS DE PIZAS REPUESTO

HAND MANUALES  
Z-SERIES  
TITANIUM DE TITANIO  
ACCESSORIES ACCESORIOS  
SCREWDRIVERS DESTORNILLADORES  
IMPACT DE IMPACTO  
SLEEVE-DRIVE  
INDUSTRIAL INDUSTRIALES  
AUTOMOTIVE  
CONSTRUCTION CONSTRUCCION  
RENEWAL KITS JUEGOS DE PIEZAS REPLUSTO

**23300M • 23300A**  6-point Sockets, deep  
Vasos Hexagonales, largos

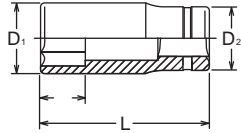

23300M (mm)	D <sub>1</sub> (mm)	D <sub>2</sub> (mm)	(mm)	L (mm)	(g)	(pcs.)
8	12	17.4	9	55	45	10
10	14.5	17.4	11	55	52	10
11	16	17.2	12	55	55	10
12	16.8	17.2	13	55	58	10
13	18	17	14	55	57	10
14	20	18	16	55	68	10
15	21	20	16	55	78	10
16	22	20	17	55	79	10
17	23.5	22	18	55	96	10
18	24.5	23	19	55	96	10
19	25	24	20	55	102	10

23300A (inch)	D <sub>1</sub> (mm)	D <sub>2</sub> (mm)	(mm)	L (mm)	(g)	(pcs.)
5/16	12	17.4	9	55	45	10
3/8	14	17.4	11	55	51	10
7/16	16	17.2	12	55	55	10
1/2	18	17	14	55	57	10
9/16	20	18	16	55	68	10
11/16	23.5	22	18	55	96	10
3/4	25	24	20	55	102	10

**23305M**  12-point Deep Sockets  
Vasos Bihexagonales Largos

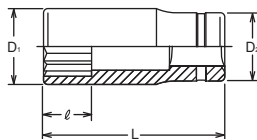

23305M (mm)	D <sub>1</sub> (mm)	D <sub>2</sub> (mm)	(mm)	L (mm)	(g)	(pcs.)
New 8	12	17.4	9	55	45	10
New 10	14.5	17.4	11	55	52	10
New 12	16.8	17.2	13	55	58	10
New 14	20	18	16	55	68	10

**23310M**  Surface Drive Sockets, deep  
Vasos Surface Drive (de Contacto Curvo) Largos

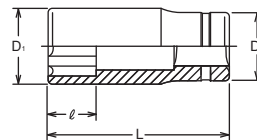

23310M (mm)	D <sub>1</sub> (mm)	D <sub>2</sub> (mm)	(mm)	L (mm)	(g)	(pcs.)
New 8	12	17.4	9	55	45	10
New 10	14.5	17.4	11	55	52	10
New 12	16.8	17.2	13	55	58	10
New 13	18	17	14	55	57	10
New 14	20	18	16	55	68	10
New 15	21	20	16	55	80	10
New 17	23.5	22	18	55	96	10

**23325**  TORX® Deep Sockets  
Vasos TORX®, largos

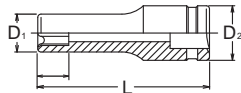

23325 (E)	D <sub>1</sub> (mm)	D <sub>2</sub> (mm)	(mm)	L (mm)	(g)	(pcs.)
E 5	6.9	17.4	5.2	55	50	10
E 6	7.9	17.4	5.4	55	52	10
E 7	8.9	17.4	6.6	55	55	10
E 8	9.9	17.4	7	55	58	10
E10	11.8	17.2	8.2	55	60	10
E12	14.5	17.2	9.3	55	68	10
E14	15.7	17.2	10.6	55	77	10
E16	18	17	11.8	55	80	10

**23760-75P • -125P • -250P** Extension Bars  
Alargaderas

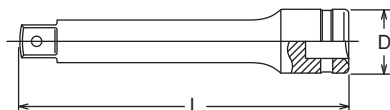

23760	D (mm)	L (mm)	(g)	(pcs.)
New 75P	18	75	70	10
New 125P	18	125	110	10
New 250P	18	250	200	5



24400M (mm)	D <sub>1</sub> (mm)	D <sub>2</sub> (mm)	(mm)	L (mm)	(g)	(pcs.)
10	15.3	21	9	37	45	10
11	16.5	21	9.5	37	46	10
12	17.8	21	10	37	47	10
13	19	22	10.5	37	53	10
14	20.3	22	11	37	56	10
15	21.5	22	11.5	37	52	10
16	22.8	22	12	37	62	10
17	24.1	23	12.5	37	69	10
18	25.1	24	13	37	74	10
19	26.6	25	14	38	89	10
20	27.9	26	15	38	92	10
21	29.1	27	15.5	38	102	10
22	30.1	28	16	40	113	10
23	31.5	29	16.5	40	128	10
24	32.9	30	17	42	140	5
26	35	32	19	42	165	5
27	36.5	33	19.5	43	196	5
29	39	35	20.5	43	190	5
30	40	36	22	46	222	5
32	42.8	38	23	46	250	5

24400A (inch)	D <sub>1</sub> (mm)	D <sub>2</sub> (mm)	(mm)	L (mm)	(g)	(pcs.)
7/16	16.5	21	9.5	37	46	10
1/2	19	22	10.5	37	53	10
9/16	20.3	22	11	37	56	10
5/8	22.9	22	12	37	62	10
3/4	26.6	25	14	38	89	10
15/16	32.9	30	17	42	140	10

24405M (mm)	D <sub>1</sub> (mm)	D <sub>2</sub> (mm)	(mm)	L (mm)	(g)	(pcs.)
New 10	15.3	21	9	37	45	10
New 12	17.8	21	10	37	47	10
New 14	20.3	22	11	37	56	10
New 17	24.1	23	12.5	37	69	10
New 19	26.6	25	14	38	89	10

24410M (mm)	D <sub>1</sub> (mm)	D <sub>2</sub> (mm)	(mm)	L (mm)	(g)	(pcs.)
New 10	15.3	21	9	37	45	10
New 12	17.8	21	10	37	47	10
New 13	19	22	10.5	37	53	10
New 14	20.3	22	11	37	56	10
New 15	21.5	22	11.5	37	52	10
New 16	22.8	22	12	37	62	10
New 17	24.1	23	12.5	37	69	10
New 18	25.1	24	13	37	74	10
New 19	26.6	25	14	38	89	10
New 21	29.1	27	15.5	38	102	10
New 22	30.1	28	16	40	113	10
New 24	32.9	30	17	42	140	10

24425 (E)	D <sub>1</sub> (mm)	D <sub>2</sub> (mm)	(mm)	L (mm)	(g)	(pcs.)
E10	13.2	21	8.2	36	68	10
E12	14.6	21	9.3	37	70	10
E14	16.5	21	10.6	37	75	10
E16	19	21.9	11.8	37	80	10
E18	20.3	21.9	13	37	83	10
E20	22.9	22	14.4	37	121	10

TORX® (E)



E	E4	E5	E6	E7	E8	E10	E11	E12	E14	E16	E18	E20	E22	E24	E26	E28
S (ref. mm)	3.83	4.72	5.69	6.17	7.47	9.37	10.03	11.12	12.85	14.71	16.64	18.41	20.24	22.10	23.85	25.65

## 24400M • 24400A

6-point Sockets  
Vasos Hexagonales

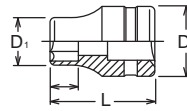

## 24405M

12-point Sockets  
Vasos Bihexagonales

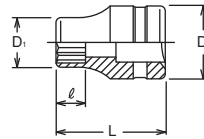

## 24410M

Surface Drive Sockets  
Vasos Surface Drive (de Contacto Curvo)

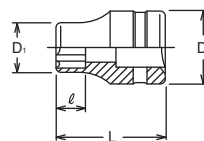

## 24425

TORX® Sockets  
Vasos TORX®

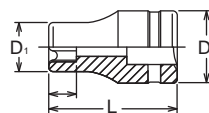

HAND  
MANUALES

Z-SERIES

TITANIUM  
DE TITANIO

ACCESSORIES  
ACCESORIOS

SCREWDRIVERS  
DESTORNILLADORES

IMPACT  
DE IMPACTO

SLEEVE-DRIVE

INDUSTRIAL  
INDUSTRIALES

AUTOMOTIVE

CONSTRUCTION  
CONSTRUCCION

RENEWAL KITS  
JUEGOS DE PIZAS REPUESTO

HAND MANUALES  
Z-SERIES  
TITANIUM DE TITANIO  
ACCESSORIES ACCESORIOS  
SCREWDRIVERS DESTORNILLADORES  
IMPACT DE IMPACTO  
SLEEVE-DRIVE  
INDUSTRIAL INDUSTRIALES  
AUTOMOTIVE  
CONSTRUCTION CONSTRUCCION  
RENEWAL KITS JUEGOS DE PIEZAS REPLUSTO

**24300M • 24300A**

6-point Sockets, deep  
Vasos Hexagonales, largos

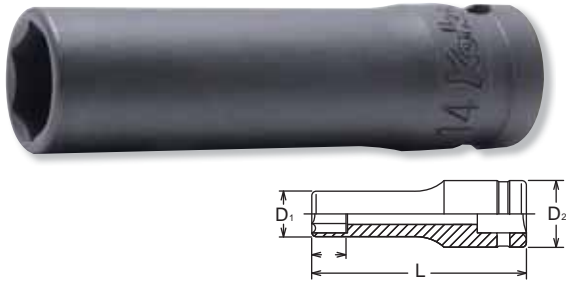

24300M (mm)	D <sub>1</sub> (mm)	D <sub>2</sub> (mm)	(mm)	L (mm)	(g)	(pcs.)
10	15.3	21	11	77	91	10
11	16.5	21	12	77	95	10
12	17.8	21	13	77	99	10
13	19	21.8	14	77	107	10
14	20.3	21.8	16	77	118	10
15	21.5	21.8	16	77	123	10
16	22.8	22	17	77	141	10
17	24	23	18	77	150	10
18	25	24	19	77	164	10
19	26.5	25	20	77	177	10
20	27.8	26	21	77	178	10
21	29	27	23	77	187	10
22	30	28	27	77	202	10
24	32.8	30	27	77	252	10
New 27	36.5	33	28	77	303	10
New 30	40	36	34	77	342	10
New 32	42.8	38	34	77	405	10

24300A (inch)	D <sub>1</sub> (mm)	D <sub>2</sub> (mm)	(mm)	L (mm)	(g)	(pcs.)
7/16	16.5	21	12	77	95	10
1/2	19	21.8	14	77	107	10
9/16	20.3	21.8	15	77	118	10
5/8	22.8	22	17	77	141	10
21/32	24	23	18	77	150	10
11/16	25	24	19	77	164	10
3/4	26.5	25	20	77	177	10
13/16	29	27	23	77	187	10
15/16	32.8	30	27	77	252	10

**24305M**

12-point Deep Sockets  
Vasos Bihexagonales Largos

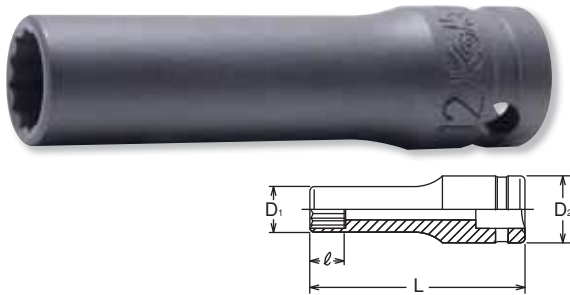

24305M (mm)	D <sub>1</sub> (mm)	D <sub>2</sub> (mm)	(mm)	L (mm)	(g)	(pcs.)
New 10	15.3	21	11	77	91	10
New 12	17.8	21	13	77	99	10
New 14	20.3	21.8	16	77	118	10
New 17	24	23	18	77	150	10
New 19	26.5	25	20	77	177	10

**24310M**

Surface Drive Sockets, deep  
Vasos Surface Drive (de Contacto Curvo) Largos

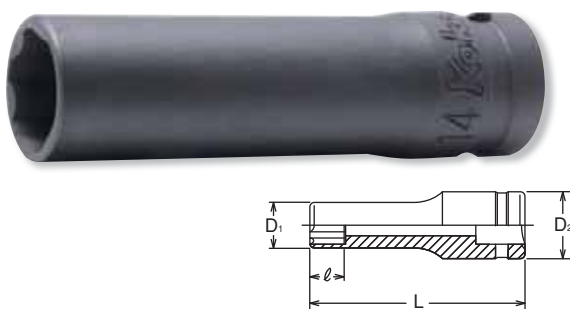

24310M (mm)	D <sub>1</sub> (mm)	D <sub>2</sub> (mm)	(mm)	L (mm)	(g)	(pcs.)
New 10	15.3	21	11	77	91	10
New 12	17.8	21	13	77	99	10
New 13	19	21.8	14	77	107	10
New 14	20.3	21.8	16	77	118	10
New 15	21.5	21.8	16	77	123	10
New 16	22.8	22	17	77	141	10
New 17	24	23	18	77	150	10
New 18	25	24	19	77	160	10
New 19	26.5	25	20	77	177	10
New 21	29	27	23	77	187	10
New 22	30	28	27	77	202	10
New 24	32.8	30	27	77	250	10

**24760-75P • -125P • -250P**

Extension Bars  
Alargaderas

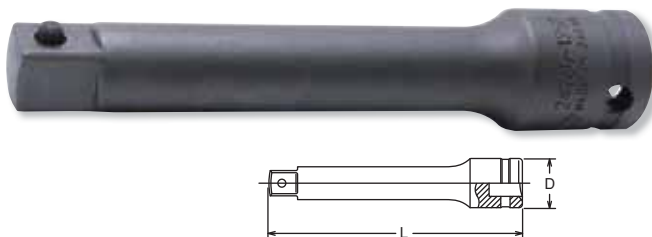

24760	D (mm)	L (mm)	(g)	(pcs.)
New 75P	24	75	140	10
New 125P	24	125	200	5
New 250P	24	250	370	5

# Automotive Tools



HAND  
MANUALES

Z-SERIES

TITANIUM  
DE TITANIO

ACCESSORIES  
ACCESORIOS

SCREWDRIVERS  
DESTORNILLADORES

IMPACT  
DE IMPACTO

SLEEVE-DRIVE

INDUSTRIAL  
INDUSTRIALES

AUTOMOTIVE

CONSTRUCTION  
CONSTRUCCIÓN

RENEWAL KITS  
JUEGOS DE PIEZAS/REPLUSTO

### 3300C · 4300C

Spark Plug Sockets with Spring Clips  
Llaves de Bujía con Presillas

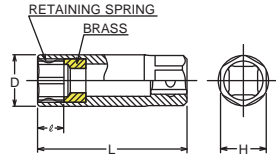

3300C (mm)	□	D (mm)	(mm)	L (mm)	H (mm)	(g)	(pcs.)
13	3/8"	17.5	11	70	17	66	10
14		19	11	70	17	82	10
16		20.5	13	70	17	91	10
18		23.9	12	70	21	140	10
20.8		26.9	13.5	70	22	132	10

4300C (mm)	□	D (mm)	(mm)	L (mm)	H (mm)	(g)	(pcs.)
16	1/2"	21	13	70	21	101	10
18		23.9	12	70	21	132	10
20.8		26.9	13.5	70	22	130	10

### 3300CB

Spark Plug Socket (BMW)  
Llave de Bujía (BMW)

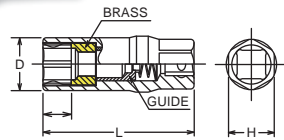

3300CB (mm)	□	D (mm)	(mm)	L (mm)	H (mm)	(g)	(pcs.)
16	3/8"	22.8	13	65	19	118	10

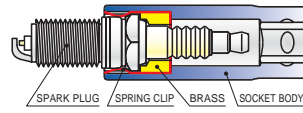

**SPARK PLUG SOCKETS with SPRING CLIP**  
An internal brass guide holds the clips in place, which ensures perfect alignment of the spark plug into the threaded plug hole of the cylinder head, thus preventing thread damage. The brass guide also eliminates stress loading and possible damage to the ceramic insulator of the spark plug.

### 3305P

Spark Plug Socket with Magnet, 12-pt. opening  
Llaves de bujía con Imán, Boca Bihex

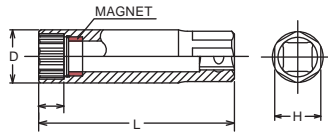

3305P (mm)	□	D (mm)	(mm)	L (mm)	H (mm)	(g)	(pcs.)
14	3/8"	19	8	70	17	87	10

Spark Plug Socket with Magnet, 12-pt. opening



### 3300S · 4300S

Spark Plug Sockets with Rubber  
Llaves de bujía con Goma

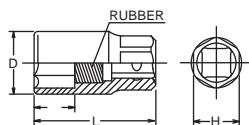

3300S (mm)	□	D (mm)	(mm)	L (mm)	H (mm)	(g)	(pcs.)
16	3/8"	20.9	19	70	17	100	10
18		23.9	21	70	21	145	10
20.8		26.9	27	70	22	140	10

4300S (mm)	□	D (mm)	(mm)	L (mm)	H (mm)	(g)	(pcs.)
16	1/2"	21	19	70	21	100	10
18		23.9	21	70	21	130	10
20.8		26.9	27	70	22	135	10

### 3300C-180 · -250

Spark Plug Sockets with Spring Clips  
Llaves de Bujía con Presillas

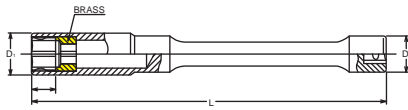

3300C.180 (mm)		D <sub>1</sub> (mm)	D <sub>2</sub> (mm)	(mm)	L (mm)	(g)	(pcs.)
14	3/8"	19	18	11	180	205	5
16		20.5	18	13	180	220	5
20.8		26.9	18	13.5	180	260	5

3300C.250 (mm)		D <sub>1</sub> (mm)	D <sub>2</sub> (mm)	(mm)	L (mm)	(g)	(pcs.)
14	3/8"	19	18	11	250	271	5
16		20.5	18	13	250	290	5
20.8		26.9	18	13.5	250	340	5

### 3305P-250

Spark Plug Socket with Magnet, 12pt. opening  
Llave de bujía con Imán, Boca Bihex

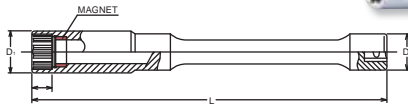

3305P.250 (mm)		D <sub>1</sub> (mm)	D <sub>2</sub> (mm)	(mm)	L (mm)	(g)	(pcs.)
14	3/8"	19	18	8	250	250	5

### 3340C · 4340C

Universal Spark Plug Sockets with Spring Clips  
Llaves de bujía con Presillas con Articulación Universal

3340C (mm)		D <sub>1</sub> (mm)	D <sub>2</sub> (mm)	(mm)	L (mm)	(g)	(pcs.)
14	3/8"	19	19	11	88	109	10
16		21	19	13	88	122	10
20.8		26.8	19	13.5	88	174	10

4340C (mm)		D <sub>1</sub> (mm)	D <sub>2</sub> (mm)	(mm)	L (mm)	(g)	(pcs.)
16	1/2"	21	25	13	100	220	10
20.8		26.8	25	13.5	100	250	10

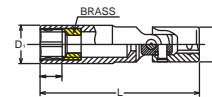

### 127C

T-type Universal Spark Plug Socket Wrench  
Llave de Bujías en T con Articulación Universal

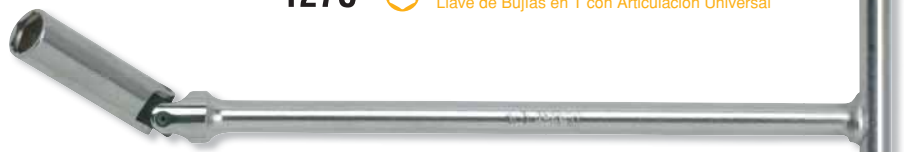

127C.315 (mm)	D (mm)	(mm)	L <sub>1</sub> (mm)	L <sub>2</sub> (mm)	(g)	(pce.)
14	19	11	315	150	520	1
16	21	13	315	150	530	1
18	23.9	12	315	150	590	1
20.8	26.8	13.5	315	150	590	1

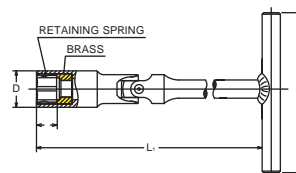



HAND  
MANUALES

Z-SERIES

TITANIUM  
DE TITANIO

ACCESSORIES  
ACCESORIOS

SCREWDRIVERS  
DESTORNILLADORES

IMPACT  
DE IMPACTO

SLEEVE-DRIVE

INDUSTRIAL  
INDUSTRIALES

AUTOMOTIVE

CONSTRUCTION  
CONSTRUCCION

RENEWAL KITS  
JUEGOS DE PIEZAS REPLÉSTO

**3751N** Torque Ratchet for Spark plugs  
Llave de Bujías Dinamométrica



**TORQUE RATCHET**

The torque is set at 25Nm. When the torque is loaded higher than 25Nm, the gear slips and no increased torque is transmitted. Cylinder heads and spark plugs are protected by this mechanism.

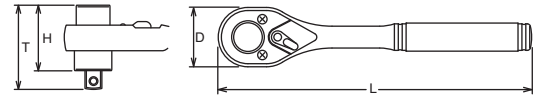

**3751J** Torque Ratchet for Spark plugs  
Llave de Bujías Dinamométrica



		D (mm)	T (mm)	H (mm)	L (mm)	(g)	(pce.)
3751N-25		34	57	43	178	320	1
3751J-25		34	57	43	178	320	1

**3225A** Set for Torque Controlled Installation of Spark Plugs  
Juego de Llaves de Bujías Dinamométricas



3225A		4 Pieces Set / $\Delta$ = 960g	
METAL CASE: W215xH80xT47mm			
Sockets		Accessories	
	3300C Spark Plug Sockets 16, 20.8		3751J-25
			3763-125

**3701-20Nm · -30Nm** Torque Adaptors 20Nm / 30Nm  
Adaptadores de Par 20Nm / 30Nm

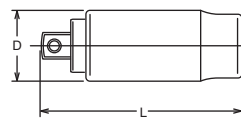

3701		D (mm)	L (mm)	(g)	(pce.)
20Nm		25.5	75	178	1
30Nm		28	75	220	1



3341G.70 (mm)		D <sub>1</sub> (mm)	D <sub>2</sub> (mm)	(mm)	L (mm)	(g)	(pcs.)
10	3/8"	14.5	19	6	70	76	10
11		15.8	19	6	70	80	10
12		17	19	6	70	85	10

3341G.89 (mm)		D <sub>1</sub> (mm)	D <sub>2</sub> (mm)	(mm)	L (mm)	(g)	(pcs.)
8	3/8"	12	19	7.5	89	82	10
9		13.3	19	7.5	89	87	10
10		14.5	19	6	89	92	10

**GLOW PLUG SOCKETS, NUT GRIP®**

Twin balls at the 6-point opening hold bolt/nut tightly for safe and reliable work.

El perno/tuerca se sujeta firmemente por medio de dos bolas en la boca hexagonal para un trabajo seguro y fiable



3342G.150 (mm)		D <sub>1</sub> (mm)	D <sub>2</sub> (mm)	(mm)	L (mm)	(g)	(pcs.)
8	3/8"	12	18	7.5	150	137	10

**3341G-70 • -89**

Universal Glow Plug Sockets with NUT GRIP®  
Llaves de Calentador con Articulación Universal con Sujeta-Tuercas (Nut Grip®)



**3342G-150**

Deep length universal Glow Plug Socket  
Llave de Calentador Larga con Articulación Universal

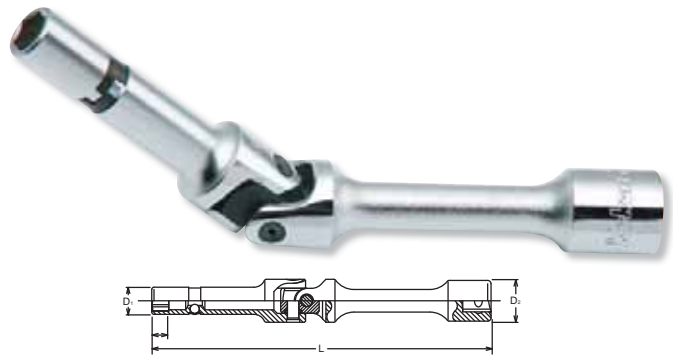

**144KM**

For Glow Plugs  
Para Calentadores



144KM (mm)	L (mm)	D (mm)	C (mm)	(g)	(pce.)
8	200	22.7	7.5	95	1
12	200	22.7	7.5	102	1

**148KM**

For Glow Plugs  
Para Calentadores



148KM (mm)	L (mm)	D <sub>1</sub> (mm)	D <sub>2</sub> (mm)	C (mm)	(g)	(pce.)
8Sx12	245	23.6	24.6	9	187	1

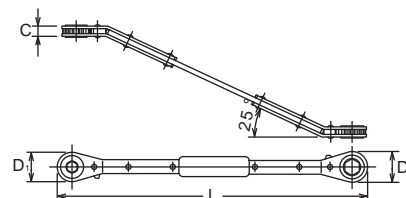

HAND MANUALES  
Z-SERIES  
TITANIUM DE TITANIO  
ACCESSORIES ACCESORIOS  
SCREWDRIVERS DESTORNILLADORES  
IMPACT DE IMPACTO  
SLEEVE-DRIVE INDUSTRIAL INDUSTRIALES  
AUTOMOTIVE  
CONSTRUCTION CONSTRUCCION  
RENEWAL KITS JUEGOS DE PIEZAS REPIESTO

HAND  
MANUALES

Z-SERIES

TITANIUM  
DE TITANIO

ACCESSORIES  
ACCESORIOS

SCREWDRIVERS  
DESTORNILLADORES

IMPACT  
DE IMPACTO

SLEEVE-DRIVE

INDUSTRIAL  
INDUSTRIALES

AUTOMOTIVE

CONSTRUCTION  
CONSTRUCCION

RENEWAL KITS  
JUEGOS DE PIEZAS REPLETO

**SP4305M-77**  Socket for Diesel engine injectors  
Vaso para Inyectores de Motor Diesel





SP4305M.77 (mm)		D <sub>1</sub> (mm)	D <sub>2</sub> (mm)	(mm)	L (mm)	 (g)	 (pcs.)
27	1/2"	36.5	33	28	77	212	10

**SP4305M.77-27**  
For fuel injection pump of BMW diesel cars.

**4133**  Socket for Diesel engine injectors  
Vaso para Inyectores de Motor Diesel



4133		D <sub>1</sub> (mm)	D <sub>2</sub> (mm)	L (mm)	 (g)	 (pcs.)
4133	1/2"	23.9	23	55	86	10

**4133**  
For fuel injection pump of M.B diesel cars.

**4122-72**  Diesel Injection Holder Nut Socket  
Vaso Porta Tuerca de Inyección Diesel

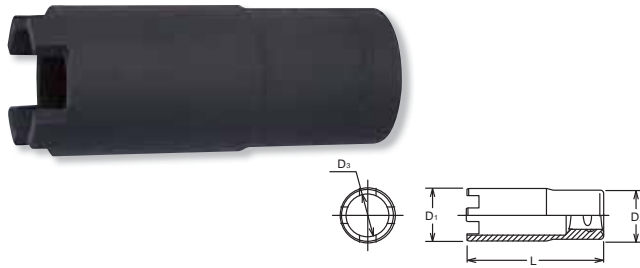



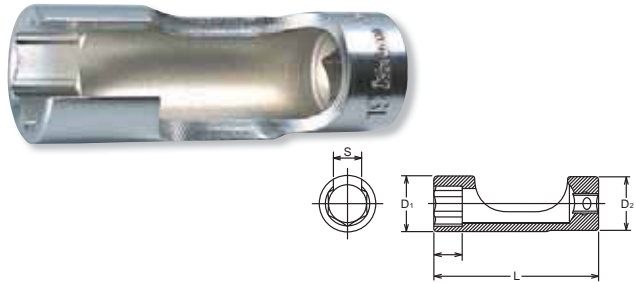

4122.72 (mm)		D <sub>1</sub> (mm)	D <sub>2</sub> (mm)	D <sub>3</sub> (mm)	L (mm)	 (g)	 (pcs.)
22	1/2"	28.5	27	22	72	150	10

**4122.72-22**  
For M.B Trucks, Holder nut of injection post.

**3300FN**  Flare Nut Sockets  
Llaves de vaso para entubar



3300FN (mm)		D <sub>1</sub> (mm)	D <sub>2</sub> (mm)	(mm)	L (mm)	S (mm)	 (g)	 (pcs.)
8	3/8"	14.5	17.3	6	53	6.4	38	10
9		16	17.3	7	53	6.8	41	10
10		16.8	17.2	7.5	53	7.2	42	10
11		18	17	8.5	53	8.3	42	10
12		20	18	9	53	8.8	50	10
13		21.1	20	9.5	62	9.4	66	10
14		22	20	10.5	62	10.5	66	10
15		23	22	11	70	11.5	82	10
16		24	23	11.5	70	12	90	10
17		25	24	12.5	80	13	110	10
18		27	25	13	80	13.5	120	10
19	28	26	14	80	14.5	130	10	

RS3300FN/6	6 Pieces Set/Rail 150mm						 (g)
8, 10, 12, 14, 17, 19							450



**RS3300FN/6**   Socket Set on Rail  
Juego de Vasos en Regleta

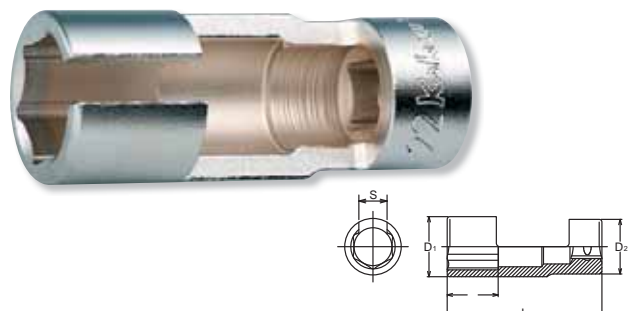

**SP4300M-85**  Special socket for Lambda Probes  
Vaso Especial para Sensores Lambda

**SP4300M-110** 



SP4300M.85-22		D <sub>1</sub> (mm)	D <sub>2</sub> (mm)	(mm)	L (mm)	S (mm)	 (g)	 (pcs.)
SP4300M.85-22	1/2"	33	30	29	85	8	228	10
SP4300M.110-22		33	30	34	110	8	279	10

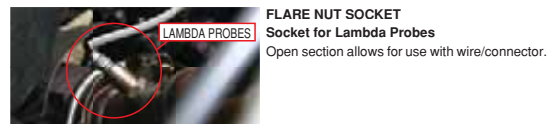

4300H (mm)		D <sub>1</sub> (mm)	D <sub>2</sub> (mm)	(mm)	L (mm)	H (mm)	(g)	(pcs.)
24		32.5	27	17	57	24	157	10
26		35	27	19	57	24	170	10
27		36.1	27	19.5	57	24	175	10

**4300H series**  
Removes and installs oil pressure switches

4300H (mm)		D <sub>1</sub> (mm)	D <sub>2</sub> (mm)	(mm)	L (mm)	(g)	(pcs.)
27(8P)		34	27	18.5	57	152	10

**4300H(8P) series**  
Socket for Switches, Mercedes Benz and MAN

4010M.100 (mm)		D (mm)	L (mm)	(g)	(pcs.)
8(12P)		23	100	132	10
10(12P)		23	100	135	10

4010M.120 (mm)		D (mm)	L (mm)	(g)	(pcs.)
8(12P)		23	120	151	10
10(12P)		23	120	155	10



**Cylinder head bolt socket for TOYOTA**  
4010M(12P) is Double Hex bit socket.  
XZN(Triple Square) bit socket has different shape.

ST4027.140		D (mm)	L (mm)	(g)	(pcs.)
ST4027.140		23	140	155	10



**Head Bolt Bit Socket for VW/AUDI**  
ST4027-140 can not substitute with 3027, 4027-CV bit series.

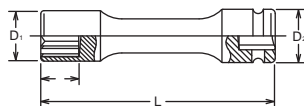

13145M.150 (12P) (mm)		D <sub>1</sub> (mm)	D <sub>2</sub> (mm)	(mm)	L (mm)	(g)	(pcs.)	
10		15.8	19	10	150	120	1	*1
12		18.3	19	12	150	128	1	*1

\*1 C-Ring=1301C, Pin/O-Ring=1301A+B → P232-233

16305M (mm)		D <sub>1</sub> (mm)	D <sub>2</sub> (mm)	(mm)	L (mm)	(g)	(pcs.)	
14		26.3	44	14	100	500	2	*1
17		30	44	17	100	544	2	*1
19		32.5	44	19	100	655	2	*1
22		36.3	44	22	100	700	2	*1

\*1 C-Ring=1600C, Pin/O-Ring=1601A+B → P232-233

**4300H** Oil Pressure Switch Sockets  
Vasos para Presostatos de Aceite

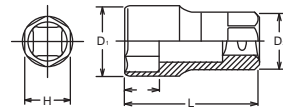

**4300H (8P)** 8-point Socket  
Vaso Octagonales

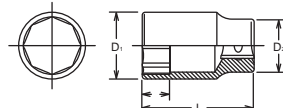

**4010M-100 · -120 (12P)**

Bit Sockets for Double Inhex Screws (12-point)  
Vasos con Punta para Tornillos Doble Inhex (Bihex)



**ST4027-140** Head Bolt Bit Socket for VW/AUDI  
Vasos con Punta para Perno de Culata VW/AUDI

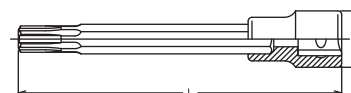

**13145M-150 · -200 (12P)**

Extra Long Sockets  
Vasos Extra-Largos



13145M.200 (12P) (mm)		D <sub>1</sub> (mm)	D <sub>2</sub> (mm)	(mm)	L (mm)	(g)	(pcs.)	
10		15.8	19	10	200	151	1	*1
12		18.3	19	12	200	159	1	*1

\*1 C-Ring=1301C, Pin/O-Ring=1301A/B → P232-233

**16305M** 12-point Sockets,deep  
Vasos Bihexagonales Largos

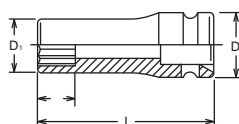

HAND MANUALES  
Z-SERIES  
TITANIUM DE TITANIO  
ACCESSORIES ACCESORIOS  
SCREWDRIVERS DESTORNILLADORES  
IMPACT DE IMPACTO  
SLEEVE-DRIVE  
INDUSTRIAL INDUSTRIALES  
AUTOMOTIVE  
CONSTRUCTION CONSTRUCCION  
RENEWAL KITS JUEGOS DE PIZAS REPUESTO

HAND MANUALES  
Z-SERIES  
TITANIUM DE TITANIO  
ACCESSORIES ACCESORIOS  
SCREWDRIVERS DESTORNILLADORES  
IMPACT DE IMPACTO  
SLEEVE-DRIVE  
INDUSTRIAL INDUSTRIALES  
AUTOMOTIVE  
CONSTRUCTION CONSTRUCCION  
RENEWAL KITS JUEGOS DE PIEZAS/REPLUSTO

**4109M**  Double square Sockets  
Vasos Octagonales

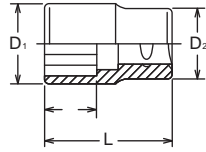

4109M (mm)		D <sub>1</sub> (mm)	D <sub>2</sub> (mm)	(mm)	L (mm)	(g)	(pcs.)
14	1/2"	26.8	26	11	38	110	10
17		30	28	12.5	40	140	10
19		31.5	29	14	40	150	10
21.5		35	32	16	40	170	10
23		37	34	16.5	43	180	10

**4109M series**  
For Lubrication service

**4111M**  6-point Socket  
Vaso Hexagonales

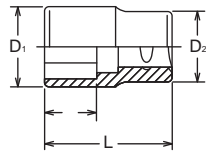

4111M (mm)		D <sub>1</sub> (mm)	D <sub>2</sub> (mm)	(mm)	L (mm)	(g)	(pcs.)
24	1/2"	32	30	17	40	133	10

**4111M**  
For Lubrication service

**4020-60 (MH)**  Bit Socket for XZN-Screws with hole  
Vaso con Punta para Tornillos XZN con agujero

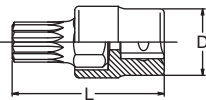

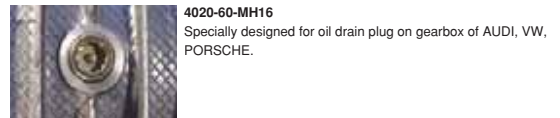

4020.60 (XZN)		D (mm)	L (mm)	(g)	(pcs.)
MH16	1/2"	24	60	135	10

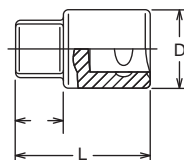

**3110M · 3110A**  4-point Male Sockets  
Vasos con Macho Cuadrado





3110M (mm)		D (mm)	(mm)	L (mm)	(g)	(pcs.)
6	3/8"	18	10	28	30	10
8		18	10	28	30	10
10		18	10	28	33	10
12		18	10	28	37	10

3110A (inch)		D (mm)	(mm)	L (mm)	(g)	(pcs.)
5/16	3/8"	18	10	28	30	10
3/8		18	10	28	33	10
1/2		18	10	28	37	10

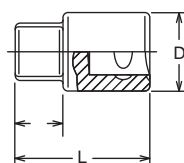
**4110M · 4110A**  4-point Male Sockets  
Vasos Macho Cuadrado



4110M (mm)		D (mm)	(mm)	L (mm)	(g)	(pcs.)
8	1/2"	24	10	32	57	10
10		24	10	32	62	10
10.5		24	10	32	64	10
12		24	10	32	64	10
13		24	10	32	66	10
13.5		24	10	32	67	10
19		25	15	37	101	10
20		26	15	37	114	10

4110A (inch)		D (mm)	(mm)	L (mm)	(g)	(pcs.)
3/8	1/2"	24	10	32	62	10
1/2		24	10	32	64	10



**158**  For Lubrication Service  
Para Lubricación





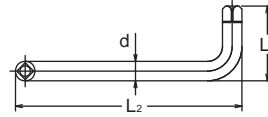

158 (mm)	L <sub>1</sub> (mm)	L <sub>2</sub> (mm)	d (mm)	(g)	(pcs.)
<b>8Sx10S</b>	63	230	13	319	1

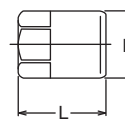

3012M.25 (mm)		D (mm)	L (mm)	(g)	(pcs.)
<b>14</b>	<b>3/8"</b>	19	25	30	10
<b>17</b>		19	25	30	10

**3012M-25**  Inhex Sockets  
Vasos con Punta Hexagonal



4202	7 Pieces Set/  =426g
METAL CASE:W190xH59xT45mm	
Sockets	
  <b>106 Drain Plug Keys</b> 8Sx10S, 8Hx3/8H, 10Hx11H, 12Hx13H, 14Hx17H, 19H	
 <b>4102 Drain Plug Key Adaptor</b>	

**4202** Drain Plug Keys Set  
Juego de Llaves de Tapón de Vaciado



106 (mm)	H (mm)	<sup>1</sup> (mm)	<sup>2</sup> (mm)	L (mm)	(g)	(pcs.)
<b>8Sx10S</b>	17	8	8	32	40	10
<b>8Hx3/8H</b>	17	8	8	32	38	10
<b>10Hx11H</b>	17	8	8	32	42	10
<b>12Hx13H</b>	17	8	8	32	47	10
<b>14Hx17H</b>	17	8	8	32	55	10
<b>19H</b>	17	-	8	24	49	10

**106**   4-point / 6-point Male bits  
Puntas Macho Cuadrado / Hexagonal

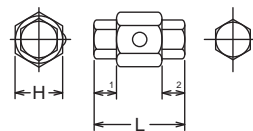

4102 (mm)		D <sub>1</sub> (mm)	D <sub>2</sub> (mm)	L (mm)	(g)	(pcs.)
<b>17</b>	<b>1/2"</b>	25	24	16	40	10

**4102**  Adaptor for 106 Drain plug key  
Adaptador para llave de tapón de Vaciado 106

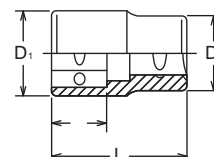

HAND  
MANUALES

Z-SERIES

TITANIUM  
DE TITANIO

ACCESSORIES  
ACCESORIOS

SCREWDRIVERS  
DESTORNILLADORES

IMPACT  
DE IMPACTO

SLEEVE-DRIVE

INDUSTRIAL  
INDUSTRIALES

AUTOMOTIVE

CONSTRUCTION  
CONSTRUCCION

RENEWAL KITS  
JUEGOS DE PIEZAS REPUESTO

HAND  
MANUALES

Z-SERIES

TITANIUM  
DE TITANIO

ACCESSORIES  
ACCESORIOS

SCREWDRIVERS  
DESTORNILLADORES

IMPACT  
DE IMPACTO

SLEEVE-DRIVE

INDUSTRIAL  
INDUSTRIALES

AUTOMOTIVE

CONSTRUCTION  
CONSTRUCCIÓN

RENEWAL KITS  
JUEGOS DE PIEZAS REPLÉSTO

**1206**  Push and Pull-Ratchet Set  
Juego de Llave de Carraca de Empuje y Tracción



1206		3 Pieces Set/⚖️=320g
CARDBOARD BOX		
Sockets		Accessory
 150.14H Sockets 12, 14	154K-14	

**154K**  Push and Pull-Ratchets  
Llaves de Carraca de Empuje y Tracción

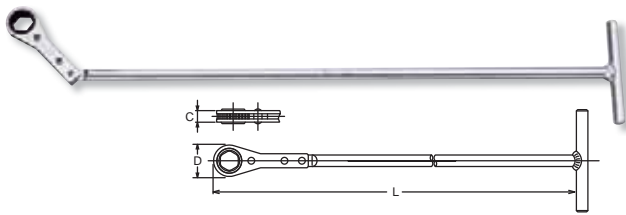

154K (mm)	L (mm)	D (mm)	C (mm)	⚖️ (g)	📦 (pcs.)
14	480	24.6	9	280	1



**150-14H**  Socket, For 154K  
Vasos



150.14H (mm)	D (mm)	(mm)	L (mm)	⚖️ (g)	📦 (pcs.)
10	16	5	17	16	10
12	17.3	5	18	14	10
14	19.2	7	21	17	10

**145LH3/8F**  Belt Tension Pulley Wrench 



145LH3/8F (LH-S)		L (mm)	D (mm)	C (mm)	⚖️ (g)	📦 (pcs.)
10S	 3/8"	100	25	15.5	90	10

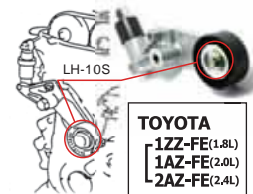

**Belt Tension Pulley Wrench**  
For LH-10S bolt on TOYOTA engines 1ZZ (1.8L), 1AZ (2.0L) and 2AZ (2.4L), belt tension pulley.

**TOYOTA**  
1ZZ-FE(1.8L)  
1AZ-FE(2.0L)  
2AZ-FE(2.4L)

 This item has less strength due to the special design.

**4282** Generator Service Set



4282		4 Pieces Set/⚖️=449g
PLASTIC BAG		
Sockets		
 4020.100-M10 4020.140-M10		
 4025.100R-T50		
 185		



**Generator Service Set**  
For removing and installing belt pulley at the generator.

**1210 · 1210E** Door Hinge Wrench Set  
Juego de Llave de Bisagra de Puerta



1210		8 Pieces Set/△=450g
PLASTIC BAG		
Sockets	Accessory	
179B.12H Sockets 10, 12	145KD-12	
179B.12H XZN Bits M6, M8, M10, M12		
179B.12H TORX® Bit T45		

1210E		11 Pieces Set/△=460g
PLASTIC BAG		
Sockets	Accessory	
179B.12H Sockets 10, 12, 13	145KD-12	
179B.12H XZN Bits M8, M10, M12		
179B.12H TORX® Bits T40, T45, T50		
179B.12H Hex Bit 8		

3247		4 Pieces Set/△=385g
PLASTIC BAG		
Sockets		
3025.160 Tamper-resistant TORX® Bit Sockets T27H, T30H, T40H, T50H		



**For Air Bag**  
For air-bag unit in hard to reach places in or around the steering wheel.

Tamper Resistant TORX® Bit Sockets have less strength.

**3247** Bit Socket Set  
Juego de Vasos con Punta



3300M/4-L120		4 Pieces Set/△=477g
PLASTIC BAG		
Sockets		
3300M(L120) 6-pt. Extra Deep Sockets 8, 10, 12, 14		



**Extra Deep Socket**  
Extra deep socket can be used to fasten or loosen longer bolts such as Bumper bolt and Door hinge etc.

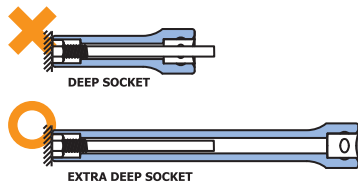

**3300M/4-L120** Socket Set  
Juego de Vasos



3350M/2-L120		2 Pieces Set/△=230g
PLASTIC BAG		
Sockets		
3350M(L120) Nut Grip Extra Deep Sockets 10, 12		

**Nut Grip Extra Deep Socket**

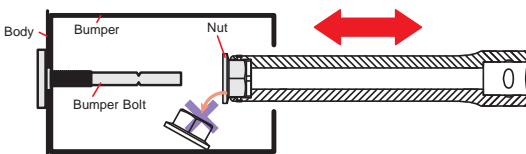

**3350M/2-L120** Socket Set  
Juego de Vasos





HAND  
MANUALES  
Z-SERIES  
TITANIUM  
DE TITANIO  
ACCESSORIES  
ACCESORIOS  
SCREWDRIVERS  
DESTORNILLADORES  
IMPACT  
DE IMPACTO  
SLEEVE-DRIVE  
INDUSTRIAL  
INDUSTRIALES  
AUTOMOTIVE  
CONSTRUCTION  
CONSTRUCCION  
RENEWAL KITS  
JUEGOS DE PIEZAS REPIESTO

HAND MANUALES  
Z-SERIES  
TITANIUM DE TITANIO  
ACCESSORIES ACCESORIOS  
SCREWDRIVERS DESTORNILLADORES  
IMPACT DE IMPACTO  
SLEEVE-DRIVE  
INDUSTRIAL INDUSTRIALES  
AUTOMOTIVE  
CONSTRUCTION CONSTRUCCION  
RENEWAL KITS JUEGOS DE PIEZAS/REPLÉSTO

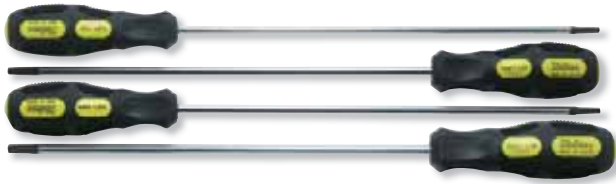
**1212**   Screwdriver set  
Destornilladores, juego de 4 piezas



**1212** 4 Pieces Set/ =380g  
PLASTIC BAG



Screwdrivers				
	<b>168T(250)</b> 20PR			
	<b>168T(250)</b> T20, T25, T30			



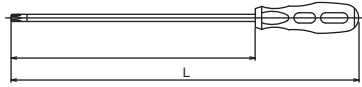

Long shank Screw Screwdriver

**168T (250)**   Screwdrivers  
Destornilladores



168T(250) (PR)	(mm)	L (mm)	 (g)	 (pce.)
<b>20PR</b>	250	350	85	1

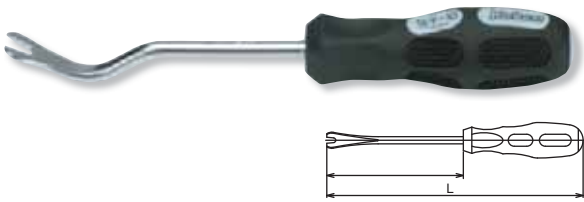

168T(250) (T)	(mm)	L (mm)	 (g)	 (pce.)
<b>T20</b>	250	350	85	1
<b>T25</b>	250	350	85	1
<b>T30</b>	250	360	120	1

**169/2** Door Trim Pad Tool, 2 pieces set  
Herramienta de Forro de Puerta, juego de 2 piezas  
**169** Door Trim Pad Tool  
Herramienta de Forro de Puerta



**169/2** 2 Pieces Set/ =200g  
PLASTIC BAG

Clip Handles				
			<b>169</b>	
			6, 10	

169	(mm)	L (mm)	 (g)	 (pcs.)
<b>6</b>	115	215	80	2
<b>10</b>	120	230	110	2





Trim Pad

Trim Clip

Clip Handle

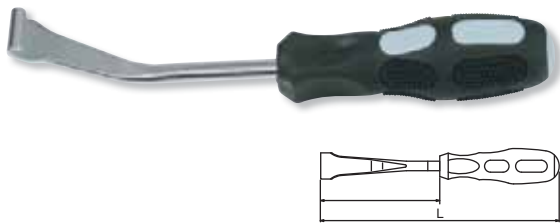
**169WM** Window Molding Remover  
Extractor de Burletes de Ventana





	(mm)	L (mm)	 (g)	 (pcs.)
<b>169WM</b>	100	210	90	2



Window Molding Remover

**169HR** Hose Remover  
Extractor de Mangueras





169HR	(mm)	L (mm)	 (g)	 (pcs.)
<b>A</b>	100	200	75	2



Hose Remover

**169BP** For Buttery Screws



169BP	TxW (mm)	(mm)	L (mm)	 (g)	 (pcs.)
<b>1.8x13</b>	1.8x13	50	150	60	2



For Battery screw



Quick Fastener

4425 (E)		D <sub>1</sub> (mm)	D <sub>2</sub> (mm)	(mm)	L (mm)	(g)	(pcs.)
<b>E10N</b>	1/2"	13.2	21	8.2	36	47	10
<b>E12N</b>		14.6	21	9.3	37	48	10
<b>E14N</b>		16.5	21	10.6	37	50	10
<b>E16N</b>		19	22	11.8	37	60	10
<b>E18N</b>		20.3	22	13	37	60	10
<b>E20N</b>		22.8	22	14.4	37	65	10

RS4425/6-N	6 Pieces Set/Rail 200mm	(g)
<b>E10N, E12N, E14N, E16N, E18N, E20N</b>		370



Engine type : QR/MR  
Flywheel bolt for NISSAN :E20N

13145A.150 (inch)		D <sub>1</sub> (mm)	D <sub>2</sub> (mm)	(mm)	L (mm)	(g)	(pce.)	
<b>9/16(D20)</b>	3/8"	20	19	13	150	130	1	*1

\*1 C-Ring=1301C, Pin/O-Ring=1301A/B → P232-233

14145A.150 (inch)		D <sub>1</sub> (mm)	D <sub>2</sub> (mm)	(mm)	L (mm)	(g)	(pce.)	
<b>9/16(D20)</b>	1/2"	20	25	13	150	200	1	*1

\*1 C-Ring=1401C, Pin/O-Ring=1401A/B → P232-233  
For Land Rover Prop Shaft

<b>13772-P</b>	3/8"	D <sub>1</sub> (mm)	D <sub>2</sub> (mm)	(mm)	L (mm)	(g)	(pce.)	
<b>14772-P</b>	1/2"	22	19	75	120	5	*1	
		27	25	90	230	1	*2	

\*1 C-Ring=1301C, Pin/O-Ring=1301A/B  
\*2 C-Ring=1401C, Pin/O-Ring=1401A/B → P232-233

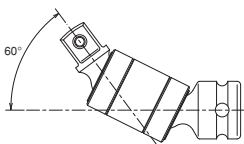

14305M (mm)		D <sub>1</sub> (mm)	D <sub>2</sub> (mm)	(mm)	L (mm)	(g)	(pcs.)	
<b>30</b>	1/2"	42	30	30	85	457	10	*1
<b>32</b>		44.5	30	32	85	542	10	*1
<b>36</b>		49.5	30	36	85	635	2	*1

\*1 C-Ring=1402C, Pin/O-Ring=1402A/B → P232-233



**4425-N** TORX® Sockets For Nut/Low Profile Head Bolt

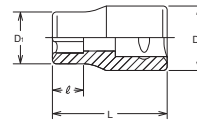

**RS4425/6-N** Socket Set on Rail Juego de Vasos en Regleta



**13145A-150** Extra Long Sockets Vasos Extra-Largos



**13772-P** Universal Double Joint Articulación Universal

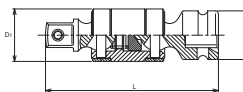

**14305M** 12-point Deep Sockets Vasos Bihexagonales Largos

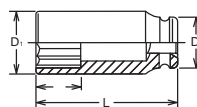

HAND MANUALES  
Z-SERIES  
TITANIUM DE TITANIO  
ACCESSORIES ACCESORIOS  
SCREWDRIVERS DESTORNILLADORES  
IMPACT DE IMPACTO  
SLEEVE-DRIVE INDUSTRIAL INDUSTRIALES  
AUTOMOTIVE  
CONSTRUCTION CONSTRUCCION  
RENEWAL KITS JUEGOS DE PIEZAS REPUESTO



HAND  
MANUALES

Z-SERIES

TITANIUM  
DE TITANIO

ACCESSORIES  
ACCESORIOS

SCREWDRIVERS  
DESTORNILLADORES

IMPACT  
DE IMPACTO

SLEEVE-DRIVE

INDUSTRIAL  
INDUSTRIALES

AUTOMOTIVE

CONSTRUCTION  
CONSTRUCCION

RENEWAL KITS  
JUEGOS DE PIEZAS REPLÉSTO

**4101 • 6101**

🔑 Sockets for Slotted Heads  
Vasos para Cabeza Ranurada

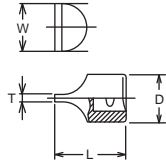

4101	🔑	T×W (mm)	D (mm)	L (mm)	(g)	(pcs.)
1	1/2"	2.7×18.6	22	40	59	10
2		3.7×24	24	40	79	10
3		3.7×30	30	40	128	10

6101	🔑	T×W (mm)	D (mm)	L (mm)	(g)	(pcs.)
6101	3/4"	6.4×33.5	35	50	205	10

**155**

Tyre Lever  
Llave de Neumáticos

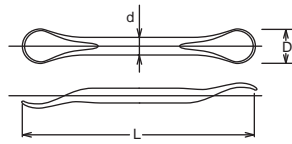

155	D (mm)	d (mm)	L (mm)	(g)	(pcs.)
155	22	10	170	100	10

For Motor Cycles

**4012M-43**

🔑 Inhex Sockets  
Vasos Inhex

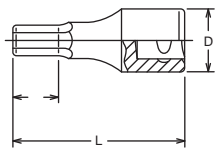

4012M.43 (mm)	🔑	D (mm)	(mm)	L (mm)	(g)	(pcs.)
20	1/2"	26	11.5	43	130	10
21		26	11.5	43	140	10
22		26	11.5	43	145	10
24		28	11.5	43	170	10
27		32	11.5	43	226	10



**4400M-DU**

🔑 Rear Wheel Nut Socket

**4405M-DU**

🔑

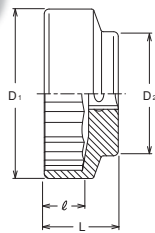

4400M	🔑	D <sub>1</sub> (mm)	D <sub>2</sub> (mm)	(mm)	L (mm)	(g)	(pcs.)
New 41DU	1/2"	53	45	15	28	240	5
New 46DU		59	48	15	28	280	5

4405M	🔑	D <sub>1</sub> (mm)	D <sub>2</sub> (mm)	(mm)	L (mm)	(g)	(pcs.)
New 55DU	1/2"	71	52	16	31	410	5



**6405A-MV**

🔑 Rear Wheel Nut Socket

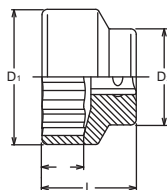

6405A	🔑	D <sub>1</sub> (mm)	D <sub>2</sub> (mm)	(mm)	L (mm)	(g)	(pcs.)
2.3/16MV	3/4"	74.6	53	23	52	790	2

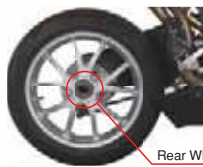

For: MV AGUSTA

Rear Wheel Nut

4300M(L60) (mm)		D (mm)	(mm)	L (mm)	H (mm)	 (g)	 (pcs.)
17		23.6	25	60	21	98	10
19		25.1	25	60	21	100	10
21		27.1	25	60	21	102	10



Wheel Nut Sockets

Please note that thin walled design is only for wheel nut work and Torque rating is limited.

4300M(L10) (mm)		D <sub>1</sub> (mm)	D <sub>2</sub> (mm)	(mm)	L (mm)	 (g)	 (pcs.)
17		23	22	32	110	155	10
19		25.8	22	32	110	170	10
21		26.8	22	32	110	165	10

Please note that thin walled design is only for wheel nut work and Torque rating is limited.

4711X		L <sub>1</sub> (mm)	L <sub>2</sub> (mm)	L <sub>3</sub> (mm)	 (g)	 (pcs.)
4711X		140	280	350	945	1

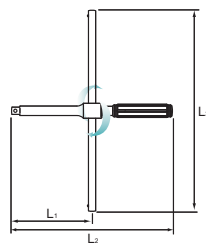

### 4300M (L60)



Wheel Nut Sockets (Long)  
Vasos para Ruedas (Largos)

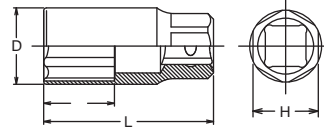

### 4300M (L110)



Wheel Nut Sockets (Long)  
Vasos para Ruedas (Largos)

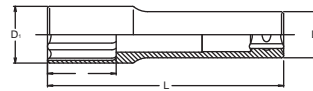

### 4711X

Spinning cross wrench



### 14201M

### 14145PM-110



Wheel Nut Sockets Set  
Juego de Vasos para Rueda



Wheel Nut Sockets  
Vasos para Rueda



14201M 3 Pieces Set/△=690g  
CARDBOARD BOX:W125xH95xT34mm  
Sockets  
 14145PM.110 Impact Wheel Nut Sockets  
17, 19, 21

14145PM.110 (mm)		D <sub>1</sub> (mm)	D <sub>2</sub> (mm)	(mm)	Shaft Color	 (g)	 (pcs.)	
17		23.7	25.2	21		223	5	*1
19		25.7	27.2	23		231	5	*1
21		27.5	29.5	25		236	5	*1
22		29	30.5	26		248	5	*1

\*1 C-Ring=1401C, Pin/O-Ring=1401A/B → P232-233



Impact Wheel Nut Sockets-Extra Thin wall  
Special design for wheel nut work.

-110mm length gives socket extra reach for nuts recessed deep inside the wheel and ideal for Aluminum wheel nuts where access to nut is very tight.

-Blue (17mm), Red (19mm), Yellow (21mm) and White (22mm), colour coded shafts make size identification easy.

-Plastic insert helps prevent damaged to wheel nut.

Please note that thin walled design is only for wheel nut work and Torque rating is limited.

- 198-17 : Spare Plastic Protector for 14145PM.110-17 : 10 pcs.
- 198-19 : Spare Plastic Protector for 14145PM.110-19 : 10 pcs.
- 198-21 : Spare Plastic Protector for 14145PM.110-21 : 10 pcs.
- 198-22 : Spare Plastic Protector for 14145PM.110-22 : 10 pcs.

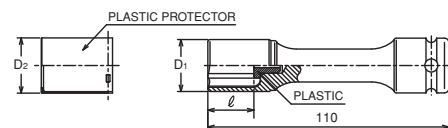

A detachable plastic protector is fitted to the socket to prevent damage to the wheel when working in tight areas.

The socket size and Ko-ken mark printed on the shaft makes it easier to see if the socket is still rotating or stopped.

HAND  
MANUALES  
Z-SERIES  
TITANIUM  
DE TITANIO  
ACCESSORIES  
ACCESORIOS  
SCREWDRIVERS  
DESTORNILLADORES  
IMPACT  
DE IMPACTO  
SLEEVE-DRIVE  
INDUSTRIAL  
INDUSTRIALES  
AUTOMOTIVE  
CONSTRUCTION  
CONSTRUCCION  
RENEWAL KITS  
JUEGOS DE PIEZAS REPUESTO

HAND  
MANUALES

Z-SERIES

TITANIUM  
DE TITANIO

ACCESSORIES  
ACCESORIOS

SCREWDRIVERS  
DESTORNILLADORES

IMPACT  
DE IMPACTO

SLEEVE-DRIVE

INDUSTRIAL  
INDUSTRIALES

AUTOMOTIVE

CONSTRUCTION  
CONSTRUCCION

RENEWAL KITS  
JUEGOS DE PIEZAS REPLUSTO



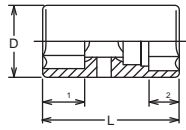

**14118M**  Wheel Nut Sockets, Double Ended  
Vasos para Rueda, Dos Bocas

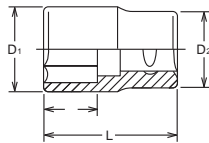

14118M (mm)		D (mm)	<sup>1</sup> (mm)	<sup>2</sup> (mm)	L (mm)	 (g)	 (pcs.)
17x19		28	15.5	13	48	150	10
19x21		31	17.5	13	57	177	10
19x22		31	17.5	15	57	187	10





**AL4400M**  Aluminium Sockets for Wheel Nuts  
Vasos de Aluminio para Tuercas de Rueda

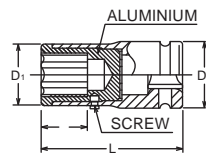

AL4400M (mm)		D <sub>1</sub> (mm)	D <sub>2</sub> (mm)	(mm)	L (mm)	 (g)	 (pcs.)
17		29.5	27	21	43	52	10
19		31	29	24	45	58	10

**AR14300**  Impact Sockets with exchangeable Aluminium Inlets  
Vasos de Impacto con Partes Internas de Aluminio Recambiables





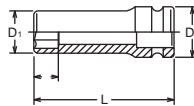

AR14300 (mm)		D <sub>1</sub> (mm)	D <sub>2</sub> (mm)	(mm)	L (mm)	 (g)	 (pcs.)	
17		28	30	21	65	220	10	*1
19		30	30	24	65	223	10	*1
21		33	30	25	65	237	10	*1

\*1 C-Ring=1402C, Pin/O-Ring=1402A/B → P232-233

**AN14300**  Impact Sockets, Aluminium alloyed, for aluminium wheel nuts  
Vasos de Impacto, de Aleación de Aluminio, para tuercas de rueda de aluminio





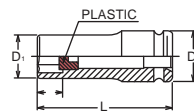

AN14300 (mm)		D <sub>1</sub> (mm)	D <sub>2</sub> (mm)	(mm)	L (mm)	 (g)	 (pcs.)	
17		25.7	30	17	80	85	10	*1
19		28.2	30	19	80	89	10	*1
21		30.7	30	21	80	93	10	*1

\*1 C-Ring=1402C, Pin/O-Ring=1402A/B → P232-233

**14113J**  Impact Sockets with Plastic Stops for Hub Cap Screws  
Vasos de Impacto con Topes de Plástico para Tornillos de Tapacubos





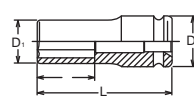

14113J (mm)		D <sub>1</sub> (mm)	D <sub>2</sub> (mm)	(mm)	L (mm)	 (g)	 (pcs.)	
17		25.7	30	14	80	251	10	*1
19		28.2	30	16	80	286	10	*1
21		30.7	30	20	80	309	10	*1

\*1 C-Ring=1402C, Pin/O-Ring=1402A/B → P232-233

**14113M**  For Hub Cap Screws  
Para Tornillos de Tapacubos



14113M (mm)		D <sub>1</sub> (mm)	D <sub>2</sub> (mm)	(mm)	L (mm)	 (g)	 (pcs.)	
17		25.7	30	34	80	230	10	*1
19		28.2	30	38	80	262	10	*1
21		30.7	30	42	80	285	10	*1

\*1 C-Ring=1402C, Pin/O-Ring=1402A/B → P232-233

14124 (mm)		D <sub>1</sub> (mm)	D <sub>2</sub> (mm)	r <sub>1</sub> (mm)	r <sub>2</sub> (mm)	L (mm)	 (g)	 (pcs.)
21×24.5	1/2"	28	29.5	24	25	65	157	10
26×27.5		31.5	35	24.5	24.5	65	197	10

14124/3		3 Pieces Set/=580g
CARDBOARD BOX:W125×H91×T43mm		
Sockets	Accessory	
<b>14124</b> 21×24.5 26×27.5	<b>14760-75B</b>	



14124 (mm)		D <sub>1</sub> (mm)	D <sub>2</sub> (mm)	r <sub>1</sub> (mm)	r <sub>2</sub> (mm)	L (mm)	 (g)	 (pcs.)	
17	1/2"	20.5	25	15	50	83	10	*1	
18		21	25	15	50	83	10	*1	
18.5		23	25	15	50	95	10	*1	
19		25	30	20.5	50	140	10	*2	
21		28	30	20.5	50	153	10	*2	
24.5		29.5	30	23	50	138	10	*2	
26		31.5	30	23	50	147	10	*2	
27.5		35	30	23	50	181	10	*2	

\*1 C-Ring=1401C, Pin/O-Ring=1401A/B  
 \*2 C-Ring=1402C, Pin/O-Ring=1402A/B  
 → P232-233

RS14124/7	7 Pieces Set/Rail 250mm	 (g)
18, 18.5, 19, 21, 24.5, 26, 27.5		980

**14124** Lock Nut Busters (Double Ended)  
 Tronzador de Tuercas (Dos Bocas)

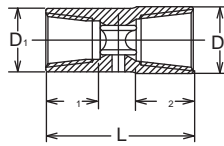

**14124/3** Lock Nut Busters (Double Ended) in set  
 Juego Tronzador de Tuercas (Dos Bocas)



**14124** Lock Nut Busters  
 Tronzador de Tuercas

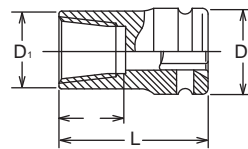

**RS14124/7** Socket Set on Rail  
 Juego de Vasos en Regleta



HAND  
MANUALES

Z-SERIES

TITANIUM  
DE TITANIO

ACCESSORIES  
ACCESORIOS

SCREWDRIVERS  
DESTORNILLADORES

IMPACT  
DE IMPACTO

SLEEVE-DRIVE

INDUSTRIAL  
INDUSTRIALES

AUTOMOTIVE

CONSTRUCTION  
CONSTRUCCION

RENEWAL KITS  
JUEGOS DE PIEZAS REPUESTO

HAND MANUALES  
Z-SERIES  
TITANIUM DE TITANIO  
ACCESSORIES ACCESORIOS  
SCREWDRIVERS DESTORNILLADORES  
IMPACT DE IMPACTO  
SLEEVE-DRIVE INDUSTRIAL INDUSTRIALES  
AUTOMOTIVE  
CONSTRUCTION CONSTRUCCION  
RENEWAL KITS JUEGOS DE PIEZAS/REPLUESTO

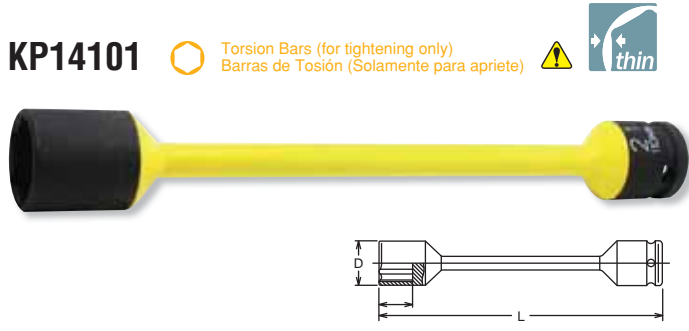

**KP14101** Torsion Bars (for tightening only)  
Barras de Torsión (Solamente para apriete)



KP14101 (mmxNm)	D (mm)	(mm)	L (mm)	Shaft Color	(g)	(pcs.)	
17x110Nm	24	21	204	Blue	230	10	*1
19x 90Nm	26	24	259	White	250	10	*1
19x110Nm	26	24	213	Red	240	10	*1
21x100Nm	28	27	215	Green	255	10	*1
21x110Nm	28	27	216	Yellow	250	10	*1
21x130Nm	28	27	207	Orange	305	10	*1

\*1 C-Ring=1401C, Pin/O-Ring=1401A/B → P232-233

**How to use Torsion Bar:**

1. Use with a 1/2" Sq. Dr. Pneumatic impact wrench.
2. Set air pressure 0.6MPa, and set impact wrench dial Medium range.
3. Chose a suitable Torsion bar according to wheel nut size and indicated tightening torque.
4. Attach the torsion bar to impact wrench and apply load.
5. Check the actual tightening torque value with torque wrench.
6. Adjust air pressure or torque value according to the results of check 5.
7. Tight other wheel nut in diagonal order.

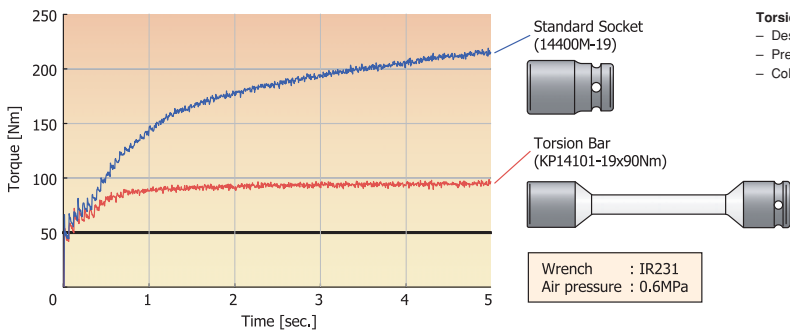

**Torsion Bars**

- Designed for tightening wheel nuts with an impact wrench.
- Prevent the excessive torque road.
- Color coded shafts make size identification easy.

**KP14101/6S** Display Stand Expositor



**KP14101/6S** 6 Pieces Set/△=2,230g

**DISPLAY STAND**

Torsion Bars  
**KP14101** Impact Torsion Bars (Thin walled)  
17x110Nm, 19x90Nm, 19x110Nm, 21x100Nm, 21x110Nm, 21x130Nm

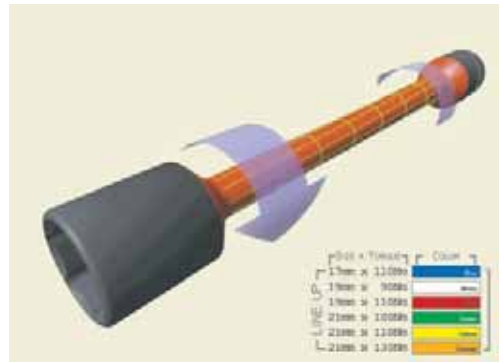

**KP14101/6H** Metal-Wall-Hanger for Workshops  
Colgador de Pared Metálico para Talleres



**KP14101/6H** 6 Pieces Set/△=2,230g



**HANGER**

Torsion Bars  
**KP14101** Impact Torsion Bars (Thin walled)  
17x110Nm, 19x90Nm, 19x110Nm, 21x100Nm, 21x110Nm, 21x130Nm

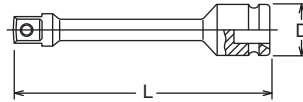

**14112**  Torsion Extension Bars (for tightening only)  
Alargaderas de Torsión (solamente para apriete) 





14112		D (mm)	L (mm)	(g)	(pce.)	
90NmP	1/2"	25	208	206	1	*1
95NmP		25	202	200	1	*1
100NmP		25	196	198	1	*1
110NmP		25	213	220	1	*1
120NmP		25	201	219	1	*1
140NmP		25	205	230	1	*1
170NmP		25	195	257	1	*1

\*1 C-Ring=1401C, Pin/O-Ring=1401A/B  P232-233

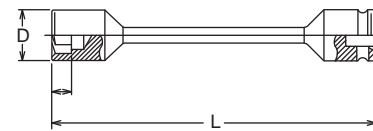
**14101M**  Torsion Bars (for tightening only)  
Barras de Torsión (solamente para apriete) 





14101M (mmxNm)		D (mm)	(mm)	L (mm)	(g)	(pce.)	
14x 95Nm	1/2"	22	11	208	230	1	*1
15x110Nm		23.2	11	201	230	1	*1
17x 60Nm		25.7	12	216	227	1	*1
17x 75Nm		25.7	12	228	240	1	*1
17x 95Nm		25.7	12	214	256	1	*1
17x110Nm		25.7	12	204	285	1	*1
17x120Nm		25.7	12	200	284	1	*1
19x 60Nm		28.2	13	219	237	1	*1
19x 90Nm		28.2	13	259	275	1	*1
19x110Nm		28.2	13	214	278	1	*1
19x120Nm		28.2	13	203	297	1	*1
19x135Nm		28.2	13	206	339	1	*1
19x170Nm		28.2	13	190	332	1	*1
21x100Nm		30.7	14	214	288	1	*1
21x120Nm		30.7	14	203	288	1	*1
22x160Nm		32	15	209	385	1	*1

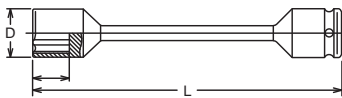

\*1 C-Ring=1401C, Pin/O-Ring=1401A/B  P232-233

**16101M · 18101M**  Torsion Bars (for tightening only)  
Barras de Torsión (solamente para apriete) 



16101M (mmxNm)		D (mm)	(mm)	L (mm)	(g)	(pce.)	
24x180Nm	3/4"	38.8	24	235	850	1	*1
27x450Nm		42.5	27	280	1236	1	*1
32x600Nm		48.8	32	280	1370	1	*1
33x600Nm		50	33	280	1370	1	*1

\*1 C-Ring=1600C, Pin/O-Ring=1601A/B  P232-233

18101M (mmxNm)		D (mm)	(mm)	L (mm)	(g)	(pce.)	
24x350Nm	1"	43.5	24	300	1380	1	*1
27x350Nm		47	27	300	1401	1	*1
27x450Nm		47	27	300	1579	1	*1
30x500Nm		51	30	300	1563	1	*1
32x450Nm		53.5	32	300	1600	1	*1
32x550Nm		53.5	32	300	1602	1	*1
32x600Nm		53.5	32	300	1602	1	*1
32x700Nm		51.5	32	300	1630	1	*1
33x550Nm		55	33	300	1638	1	*1
33x600Nm		55	33	300	1638	1	*1
36x600Nm		58.5	36	300	1718	1	*1

\*1 C-Ring=1801C, Pin/O-Ring=1801A/B  P232-233

 As the torque could vary with the type and the condition of the impact wrench, we strongly recommend the control with a torque wrench.

Como el par puede variar según el estado de la llave de impacto, se recomienda utilizar una llave dinamométrica.

HAND  
MANUALES

Z-SERIES

TITANIUM  
DE TITANIO

ACCESSORIES  
ACCESORIOS

SCREWDRIVERS  
DESTORNILLADORES

IMPACT  
DE IMPACTO

SLEEVE-DRIVE

INDUSTRIAL  
INDUSTRIALES

AUTOMOTIVE

RENEWAL KITS  
JUEGOS DE PIEZAS REPLÉSTO

CONSTRUCTION  
CONSTRUCCIÓN

# 6102M-400 8102M-400

Extra long Sockets for wheel Nuts  
Vasos de para Rueda Extra-largos

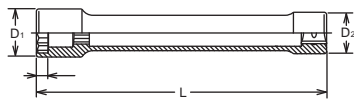

6102M.400 (mm)	□	D <sub>1</sub> (mm)	D <sub>2</sub> (mm)	(mm)	L (mm)	(g)	(pce.)
41Wx21W	3/4"	58	40	14	400	1880	1
32		48.5	40	32	400	1480	1
33		49.8	40	32	400	1500	1

8102M.400 (mm)	□	D <sub>1</sub> (mm)	D <sub>2</sub> (mm)	(mm)	L (mm)	(g)	(pce.)
41Wx21W	1"	58	49.9	14	400	2610	1
32		48.5	49.9	32	400	2210	1
33		49.8	49.9	32	400	2220	1

⚠ 6102M/8102M are for hand use only. Do not use with a power impact wrench.



Extra long Socket for wheel nut



Combination type.  
41Wx21W

# 16102M-270 · -400 18102M-270 · -400

Extra long Sockets for wheel Nuts  
Vasos de Impact para Rueda Extra-largos

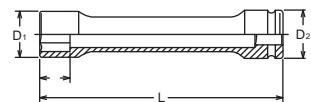

16102M.270 (mm)	□	D <sub>1</sub> (mm)	D <sub>2</sub> (mm)	(mm)	L (mm)	(g)	(pce.)	⚡
24	3/4"	38.8	44	24	270	1034	1	*1
27		42.5	44	27	270	1088	1	*1
30		46.3	44	30	270	1144	1	*1
32		48.8	44	32	270	1157	1	*1
33		50	44	32	270	1200	1	*1
36		53.8	44	32	270	1250	1	*1

\*1 C-Ring=1600C, Pin/O-Ring=1601A/B → P232-233

16102M.400 (mm)	□	D <sub>1</sub> (mm)	D <sub>2</sub> (mm)	(mm)	L (mm)	(g)	(pce.)	⚡
24	3/4"	38.8	44	24	400	1430	1	*1
27		42.5	44	27	400	1460	1	*1
30		46.3	44	30	400	1510	1	*1
32		48.8	44	32	400	1530	1	*1
33		50	44	32	400	1530	1	*1
36		53.8	44	32	400	2180	1	*1

\*1 C-Ring=1600C, Pin/O-Ring=1601A/B → P232-233

18102M.270 (mm)	□	D <sub>1</sub> (mm)	D <sub>2</sub> (mm)	(mm)	L (mm)	(g)	(pce.)	⚡
23	1"	37.3	54	23	270	1627	1	*1
24		38.5	54	24	270	1628	1	*1
26		41	54	26	270	1667	1	*1
27		42.3	54	27	270	1680	1	*1
29		44.8	54	29	270	1680	1	*1
30		46	54	30	270	1680	1	*1
32		48.5	54	32	270	1680	1	*1
33		49.8	54	32	270	1700	1	*1
34		51	54	32	270	1750	1	*1
36		53.5	54	32	270	1750	1	*1
38		56	54	32	270	1822	1	*1

\*1 C-Ring=1801C, Pin/O-Ring=1801A/B → P232-233

18102M.400 (mm)	□	D <sub>1</sub> (mm)	D <sub>2</sub> (mm)	(mm)	L (mm)	(g)	(pce.)	⚡
23	1"	37.3	54	23	400	1865	1	*1
24		38.5	54	24	400	1869	1	*1
26		41	54	26	400	1925	1	*1
27		42.3	54	27	400	2272	1	*1
29		44.8	54	29	400	2278	1	*1
30		46	54	30	400	2266	1	*1
32		48.5	54	32	400	2322	1	*1
33		49.8	54	32	400	2320	1	*1
34		51	54	32	400	2341	1	*1
36		53.5	54	32	400	2442	1	*1
38		56	54	32	400	2550	1	*1

\*1 C-Ring=1801C, Pin/O-Ring=1801A/B → P232-233

PW6 (mmxmm)		D <sub>1</sub> (mm)	D <sub>2</sub> (mm)	(mm)	L (mm)	(g)	(pcs.)	
32x17	3/4"	47	44	12	75	633	2	*1
35x17		50	44	13	75	673	2	*1
38x20		55	44	14	75	708	2	*1
41x19		58	44	14	80	840	2	*1
41x20		58	44	14	80	840	2	*1
41x21		58	44	14	80	831	2	*1

\*1 C-Ring=1600C, Pin/O-Ring=1601A/B → P232-233

PW8 (mmxmm)		D <sub>1</sub> (mm)	D <sub>2</sub> (mm)	(mm)	L (mm)	(g)	(pcs.)	
35x17	1"	50	54	13	83	935	2	*1
38x20		55	54	14	83	1038	2	*1
41x19		58	54	14	87	1100	2	*1
41x20		58	54	14	87	1096	2	*1
41x21		58	54	14	87	1089	2	*1

\*1 C-Ring=1801C, Pin/O-Ring=1801A/B → P232-233

SIZE	VEHICLE	SIZE	VEHICLE
32 x 17	TOYOTA ~ 2t	41 x 19	MAZDA 3 - 4t
35 x 17	NISSAN MITSUBISHI MAZDA ISUZU ( ~ 3t ~ 1t ~ 2t ~ 3.5t )	41 x 20	TOYOTA DAIHATSU HINO 2t - ( 2 - 3.5t ( 2 - 3.5t )
38 x 20	MITSUBISHI 2 - 3.5t	41 x 21	NISSAN MITSUBISHI ISUZU HINO 4t - 2t - 4t - 4t -

<b>PW8P/4</b>		4 Pieces Set/⚖️=4,250g	
CARDBOARD BOX:W240xH95xT70mm			
Sockets			
<b>PW8P Impact Rear Wheel Nut Sockets</b> 35x17, 38x20, 41x19, 41x21			

PW8P (mmxmm)		D <sub>1</sub> (mm)	D <sub>2</sub> (mm)	(mm)	L (mm)	(g)	Shaft Color	(pcs.)	
35x17	1"	50	54	13	83	935	White	5	*1
38x20		55	54	14	83	1038	Red	5	*1
41x19		58	54	14	87	1100	Green	5	*1
41x21		58	54	14	87	1089	Yellow	5	*1

\*1 C-Ring=1801C, Pin/O-Ring=1801A/B → P232-233

PW8L (mmxmm)		D <sub>1</sub> (mm)	D <sub>2</sub> (mm)	(mm)	L (mm)	(g)	(pcs.)	
41x21	1"	58	54	15	105	1263	1	*1

\*1 C-Ring=1801C, Pin/O-Ring=1801A/B → P232-233

PW6 (mm)		D <sub>1</sub> (mm)	D <sub>2</sub> (mm)	(mm)	L (mm)	(g)	(pcs.)	
17	3/4"	40	44	19	53	433	2	*1
19		40	44	19	53	419	2	*1
20		44	44	21	55	483	2	*1
21		44	44	23	57	491	2	*1

\*1 C-Ring=1600C, Pin/O-Ring=1601A/B → P232-233

PW8 (mm)		D <sub>1</sub> (mm)	D <sub>2</sub> (mm)	(mm)	L (mm)	(g)	(pcs.)	
17	1"	40	54	19	60	621	2	*1
19		43	54	19	60	648	2	*1
20		45	54	21	62	687	2	*1
21		45	54	23	64	696	2	*1

\*1 C-Ring=1801C, Pin/O-Ring=1801A/B → P232-233

**PW6 · PW8** Rear Wheel Nut Sockets  
Vasos de Tuerca de Rueda Interna



Tightening / Loosening Outer Nut

Tightening / Loosening Inner Nut

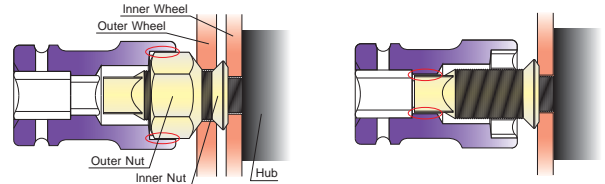

**PW8P/4  
PW8P** Socket set of Rear Wheel Nut Sockets  
Juego de Vasos de Tuerca de Rueda Interna

Rear Wheel Nut Sockets  
Vasos de Tuerca de Rueda Interna



**PW8L** Rear Wheel Nut Socket (long)  
Vasos de Tuerca de Rueda Interna (largos)



**PW6 · PW8** Rear Wheel Nut Sockets  
Vasos de Tuerca de Rueda Interna



HAND  
MANUALES  
Z-SERIES  
TITANIUM  
DE TITANIO  
ACCESSORIES  
ACCESORIOS  
SCREWDRIVERS  
DESTORNILLADORES  
IMPACT  
DE IMPACTO  
SLEEVE-DRIVE  
INDUSTRIAL  
INDUSTRIALES  
AUTOMOTIVE  
CONSTRUCTION  
CONSTRUCCION  
RENEWAL KITS  
JUEGOS DE PIEZAS REPUESTO

HAND MANUALES  
Z-SERIES  
TITANIUM DE TITANIO  
ACCESSORIES ACCESORIOS  
SCREWDRIVERS DESTORNILLADORES  
IMPACT DE IMPACTO  
SLEEVE-DRIVE  
INDUSTRIAL INDUSTRIALES  
AUTOMOTIVE  
CONSTRUCTION CONSTRUCCION  
RENEWAL KITS JUEGOS DE PIEZAS REPLUSTO

**16316M • 16316A**  
**18316M • 18316A**

Rear Wheel Nut Sockets  
Vasos de Tuerca de Rueda Interna

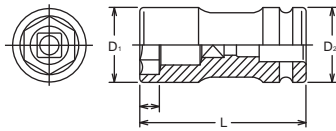

16316M (mmxmm)		D <sub>1</sub> (mm)	D <sub>2</sub> (mm)	(mm)	L (mm)	(g)	(pce.)	
35x17	3/4"	52	44	10	90	865	1	*1
38x20		56	44	13	100	952	1	*1
41x19		59	44	12	100	1037	1	*1
41x21		59	44	15	100	963	1	*1

\*1 C-Ring=1600C, Pin/O-Ring=1601A/B → P232-233

16316A (inchxinch)		D <sub>1</sub> (mm)	D <sub>2</sub> (mm)	(mm)	L (mm)	(g)	(pce.)	
1.1/2x13/16	3/4"	56	44	13	100	940	1	*1

\*1 C-Ring=1600C, Pin/O-Ring=1601A/B → P232-233

18316M (mmxmm)		D <sub>1</sub> (mm)	D <sub>2</sub> (mm)	(mm)	L (mm)	(g)	(pce.)	
35x17	1"	52	54	10	108	1153	1	*1
38x20		56	54	13	108	1133	1	*1
41x19		59	54	12	108	1200	1	*1
41x21		59	54	15	108	1155	1	*1

\*1 C-Ring=1801C, Pin/O-Ring=1801A/B → P232-233

18316A (inchxinch)		D <sub>1</sub> (mm)	D <sub>2</sub> (mm)	(mm)	L (mm)	(g)	(pce.)	
1.1/2x13/16	1"	59	54	13	108	1120	1	*1

\*1 C-Ring=1801C, Pin/O-Ring=1801A/B → P232-233

**16317M • 16317A**  
**18317M • 18317A**

Rear Wheel Nut Sockets  
Vasos de Tuerca de Rueda Interna

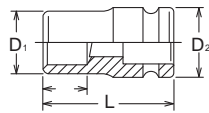

16317M (mm)		D <sub>1</sub> (mm)	D <sub>2</sub> (mm)	(mm)	L (mm)	(g)	(pce.)	
17	3/4"	40	44	22.5	67	485	1	*1
19		40	44	22.5	67	462	1	*1
20		44	44	22.5	67	517	1	*1
21		44	44	22.5	67	489	1	*1
22		44	44	22.5	67	482	1	*1

\*1 C-Ring=1600C, Pin/O-Ring=1601A/B → P232-233

16317A (inch)		D <sub>1</sub> (mm)	D <sub>2</sub> (mm)	(mm)	L (mm)	(g)	(pce.)	
13/16	3/4"	44	44	22.5	67	489	1	*1

\*1 C-Ring=1600C, Pin/O-Ring=1601A/B → P232-233

18317M (mm)		D <sub>1</sub> (mm)	D <sub>2</sub> (mm)	(mm)	L (mm)	(g)	(pce.)	
17	1"	40	54	22.5	72	682	1	*1
17.5		40	54	22.5	72	677	1	*1
19		43	54	22.5	72	705	1	*1
20		45	54	22.5	72	723	1	*1
20.5		45	54	22.5	72	723	1	*1
21		45	54	22.5	72	703	1	*1
22		45	54	22.5	72	696	1	*1

\*1 C-Ring=1801C, Pin/O-Ring=1801A/B → P232-233

18317A (inch)		D <sub>1</sub> (mm)	D <sub>2</sub> (mm)	(mm)	L (mm)	(g)	(pce.)	
13/16	1"	45	54	22.5	72	703	1	*1

\*1 C-Ring=1801C, Pin/O-Ring=1801A/B → P232-233

# Construction





HAND MANUALES  
Z-SERIES  
TITANIUM DE TITANIO  
ACCESSORIES ACCESORIOS  
SCREWDRIVERS DESTORNILLADORES  
IMPACT DE IMPACTO  
SLEEVE-DRIVE  
INDUSTRIAL INDUSTRIALES  
AUTOMOTIVE  
CONSTRUCTION CONSTRUCCIÓN  
RENEWAL KITS JUEGOS DE PIEZAS REPLUSTO

**BD014E** 12-point Nut Setters, deep  
Vasos Bihex para Apretar Tuercas, largos

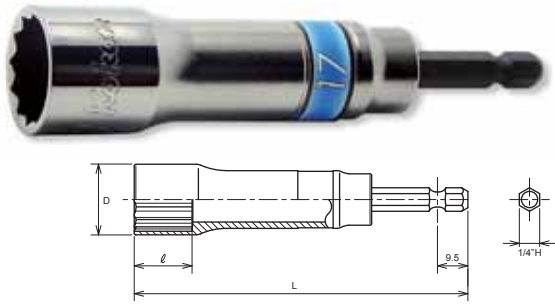

BD014E (mm)	D (mm)	(mm)	L (mm)	(g)	(pcs.)
8	12	12	104	50	10
10	14	12	104	58	10
12	16.5	18	104	73	10
13	17.5	18	104	78	10
14	19	18	104	83	10
17	22.5	18	104	111	10
19	24.5	18	104	128	10
21	27	18	104	150	10
22	28	18	104	157	10
24	30.3	18	104	180	10

**BD014SE** 12-point Nut Setters  
Vasos Bihex para Apretar Tuercas

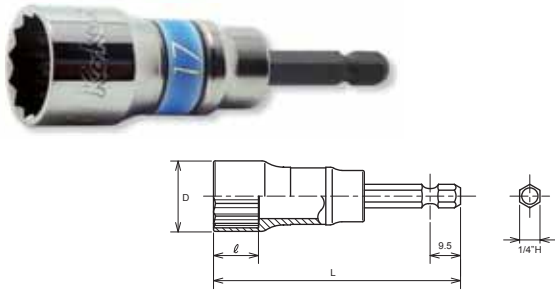

BD014SE (mm)	D (mm)	(mm)	L (mm)	(g)	(pcs.)
8	12	12	77	35	10
10	14	12	77	38	10
12	16.5	14	77	48	10
13	17.5	14	77	51	10
14	19	14	77	54	10
17	22.5	14	77	76	10
19	24.5	14	77	83	10
21	27	14	77	104	10
22	28	14	77	120	10
24	30.3	14	77	140	10

**BD008E-165 (12P)** 12-point Nut Setters, extra long  
Vasos Bihex para Apretar Tuercas

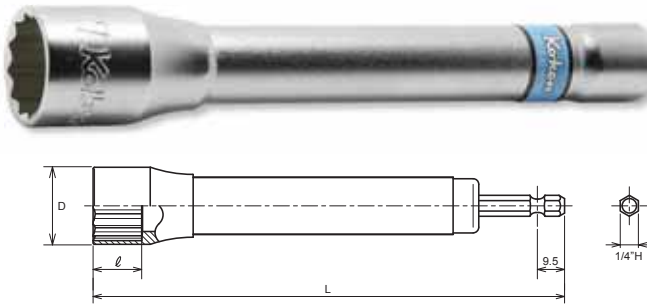

BD008E-165 (mm)	D (mm)	(mm)	L (mm)	(g)	(pcs.)
17(12P)	22.5	17	165	178	10
19(12P)	24.5	17	165	195	10
21(12P)	27	17	165	233	10

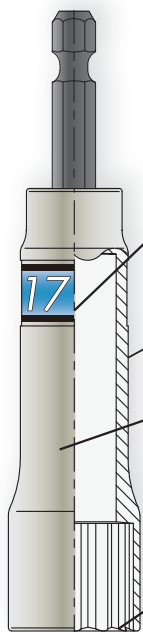

**Color Coded**

Easy identification for the sizes.

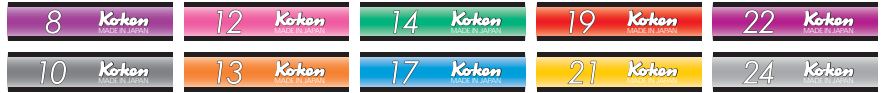

**Light Body Design**

New BD011SE, BD014E and BD014SE are designed the weight up to 30% lighter for easy handling.

**Dark Colour Chrome Plating**

Surface treatment is changed to Dark Colour Chrome Plating. \*except BD008E series

**12 point Opening**

Socket opening is designed to 12-point opening to catch a bolt/nut easy.

BD011SE (mm)	D (mm)	(mm)	L (mm)	(g)	(pcs.)
10	14	12	100	85	10
12	16.5	12	100	90	10
13	17.5	12	100	95	10
14	19	12	100	100	10
17	22.5	14	100	115	10
19	24.5	14	100	120	10
21	27	14	100	140	10
22	28	14	100	150	10

**BD011SE** 12-point Universal Joint Nut Setters  
Vasos Bihex para Apretar Tuercas con Articulación Universal

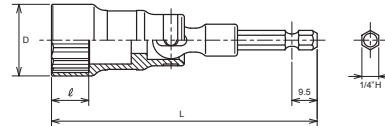

113.50 (mm)	D (mm)	(mm)	L (mm)	(g)	(pcs.)
5.5	9	4	50	15	10
6	10	5	50	17	10
7	11	5	50	19	10
8	12	6	50	20	10
10	14	7	50	31	10
12	17	8	50	39	10
13	18	8	50	42	10
14	19	9	50	46	10

**113-50** Nut Setters  
Vasos para apretar tuercas Hexagonales

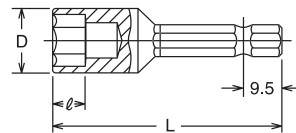

113.50 (inch)	D (mm)	(mm)	L (mm)	(g)	(pcs.)
1/4	10	5	50	17	10
5/16	12	6	50	20	10
3/8	14	7	50	31	10
1/2	18	8	50	42	10

**115-50** Nut Setters with Magnet  
Vasos para tuercas con Imán

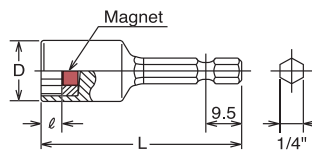

115.50 (mm)	D (mm)	(mm)	L (mm)	(g)	(pcs.)
5.5	9	2.1	50	15	10
6	10	2.4	50	17	10
7	11	2.8	50	19	10
8	12	3.5	50	20	10
10	14	4.2	50	29	10
12	17	5.6	50	40	10
13	18	6	50	50	10
14	19	6.4	50	60	10

115.50 (inch)	D (mm)	(mm)	L (mm)	(g)	(pcs.)
1/4	10	1.8	50	17	10
1/4(DP2.4)	10	2.4	50	17	10
5/16	12	3.5	50	20	10
3/8	14	4.2	50	29	10
1/2	18	6	50	50	10

**ANBD007E** 6-point Aluminium Nut Setters  
Vasos Hex para Apretar Tuercas

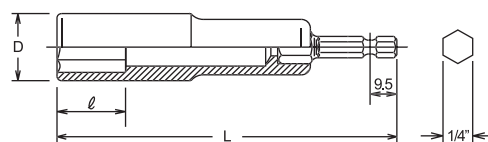

ANBD007E (mm)	D (mm)	(mm)	L (mm)	(g)	(pcs.)
8	14	12	115	37	10
9	15	14	115	40	10
10	16	15	115	43	10
11	18	17	115	48	10
12	19	18	115	50	10
13	20	20	115	53	10
14	21	21	115	57	10
17	25	26	115	74	10
19	27	29	115	80	10
21	30	32	115	91	10

HAND  
MANUALES

Z-SERIES

TITANIUM  
DE TITANIO

ACCESSORIES  
ACCESORIOS

SCREWDRIVERS  
DESTORNILLADORES

IMPACT  
DE IMPACTO

SLEEVE-DRIVE

INDUSTRIAL  
INDUSTRIALES

AUTOMOTIVE

CONSTRUCTION  
CONSTRUCCION

RENEWAL KITS  
JUEGOS DE PIEZAS REPUESTO

HAND  
MANUALES

Z-SERIES

TITANIUM  
DE TITANIO

ACCESSORIES  
ACCESORIOS

SCREWDRIVERS  
DESTORNILLADORES

IMPACT  
DE IMPACTO

SLEEVE-DRIVE

INDUSTRIAL  
INDUSTRIALES

AUTOMOTIVE

CONSTRUCTION  
CONSTRUCCIÓN

RENEWAL KITS  
JUEGOS DE PIEZAS REPLÉSTO

### BD003E-I

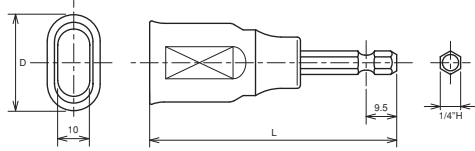

	D (mm)	L (mm)	(g)	(pcs.)
<b>BD003E-I</b>	25	70	95	10

### BD013E

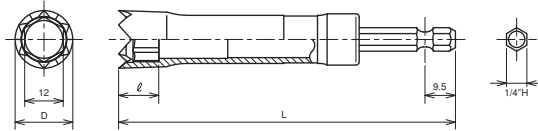

BD013E (mm)	D (mm)	(mm)	L (mm)	(g)	(pcs.)
<b>12</b>	17.8	12.5	105	80	2

### BD008E-300 · -500 · -700 (12P)



12-point Nut Setters, extra long  
Vasos Bihex para Apretar Tuercas

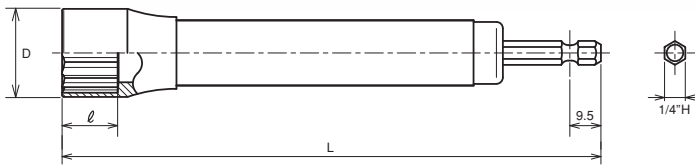

BD008E.300 (mm)	D (mm)	(mm)	L (mm)	(g)	(pcs.)
<b>New 17(12P)</b>	22.5	17	300	154	2

BD008E.500 (mm)	D (mm)	(mm)	L (mm)	(g)	(pcs.)
<b>New 17(12P)</b>	22.5	17	500	223	2

BD008E.700 (mm)	D (mm)	(mm)	L (mm)	(g)	(pcs.)
<b>New 17(12P)</b>	22.5	17	700	292	2

### BD017E

Wing Bolt Socket for Electric Drill  
Vaso para Tuerca de Orejetas para Taladro eléctrico

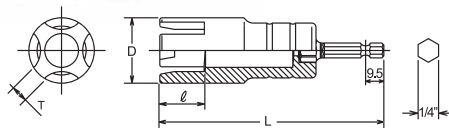

	D (mm)	T (mm)	(mm)	L (mm)	(g)	(pcs.)
<b>BD017E</b>	31	7.3	21	104	158	10

### BD018

Wing Bolt Socket  
Vaso para Tuerca de Orejetas

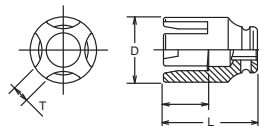

	D (mm)	T (mm)	(mm)	L (mm)	(g)	(pcs.)		
<b>BD018</b>	<b>3/8"</b>	31	7.3	21	45	113	10	*1

\*1 C-Ring=1302C, Pin/O-Ring=1401A/B → P232-233

	BD023E		D (mm)	L (mm)	(g)	(pcs.)
New	3/8	3/8"	6.35	55	45	10
New	1/2	1/2"	6.35	60	50	10

**BD023E** Adaptor  
Adaptador

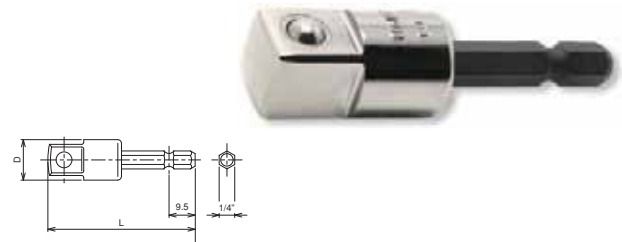

	BD024E		D (mm)	L (mm)	(g)	(pcs.)
	3/8	3/8"	6.35	78	70	10
	1/2	1/2"	6.35	82	75	10

**BD024E** Universal Adaptors  
Adaptadores Universal

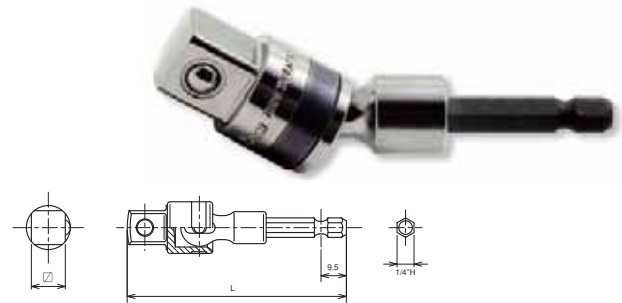

123PN.65 123PG.65 (PH)	D (mm)	L (mm)	(g)	(pcs.)
1	6.35	65	13	10
2	6.35	65	13	10
3	6.35	65	14	10

123PN.110 123PG.110 (PH)	D (mm)	L (mm)	(g)	(pcs.)
1	6.35	110	25	10
2	6.35	110	25	10
3	6.35	110	26	10

  

123PN.150 123PG.150 (PH)	D (mm)	L (mm)	(g)	(pcs.)
1	6.35	150	36	10
2	6.35	150	36	10
3	6.35	150	37	10

Groove position: Japanese model

**123PN-65 · -110 · -150** Double ended Bits  
Puntas Phillips, simétricas

**123PG-65 · -110 · -150** Magnetic type

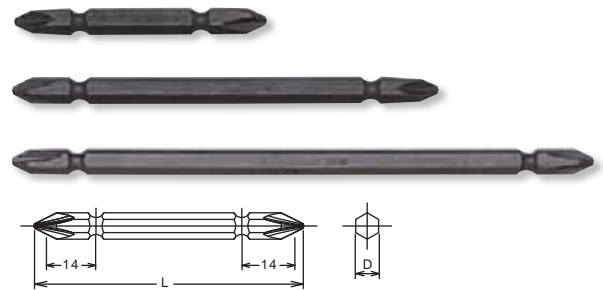

HAND  
MANUALES

Z-SERIES

TITANIUM  
DE TITANIO

ACCESSORIES  
ACCESORIOS

SCREWDRIVERS  
DESTORNILLADORES

IMPACT  
DE IMPACTO

SLEEVE-DRIVE

INDUSTRIAL  
INDUSTRIALES

AUTOMOTIVE



CONSTRUCTION  
CONSTRUCCION

RENEWAL KITS  
JUEGOS DE PIEZAS REPIESTO

HAND MANUALES  
Z-SERIES  
TITANIUM DE TITANIO  
ACCESSORIES ACCESORIOS  
SCREWDRIVERS DESTORNILLADORES  
IMPACT DE IMPACTO  
SLEEVE-DRIVE  
INDUSTRIAL INDUSTRIALES  
AUTOMOTIVE  
CONSTRUCTION CONSTRUCCIÓN  
RENEWAL KITS JUEGOS DE PIEZAS REPLUESTO

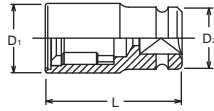
**BD004**  Impact Screw and Stud Setters  
Vasos de Impacto para Atornillar Pernos y Espárragos







BD004 (mm)		D <sub>1</sub> (mm)	D <sub>2</sub> (mm)	L (mm)	 (g)	 (pcs.)
12.5x10	1/2"	30	25	70	236	5
12.5x13		38	30	75	388	3
12.5x16		38	30	75	369	3
20 x19	3/4"	48	44	90	775	3
20 x22		48	44	90	752	3
20 x25		62	44	95	1184	2
20 x29		62	44	95	1148	2

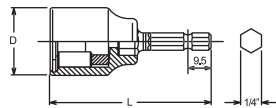

**162E**  Stud Setters  
Vasos de Atornillar Espárragos





162E (mm)	D (mm)	L (mm)	 (g)	 (pcs.)
10	27.9	66	107	10

162E (inch)	D (mm)	L (mm)	 (g)	 (pcs.)
1/4	23	66	83	10
5/16	23	66	82	10
3/8	27.9	66	107	10
1/2	27.9	66	108	10

\*Renewal Kits → 162RK → P279

**142**  Stud Setters  
Vasos de Atornillar Espárragos



142 (inch)	L (mm)	 (g)	 (pce.)
5/16	190	304	1
3/8	190	361	1
1/2	190	354	1

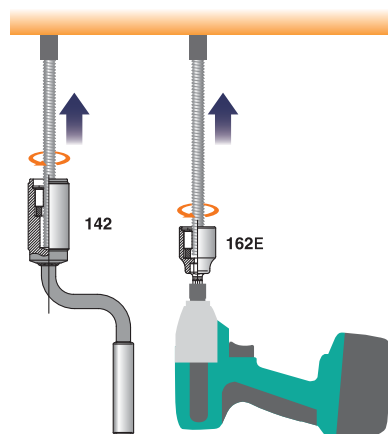



141S (mm)	D (mm)	L (mm)	(g)	(pce.)
6	28	120	150	1
8	28	120	150	1
10	32	120	153	1
12	32	120	152	1

141S (inch)	D (mm)	L (mm)	(g)	(pce.)
5/16	28	120	150	1
3/8	32	120	153	1
1/2	32	120	152	1

**141S** Stud Puller Ratchets  
Extractores de Espárragos de Carraca

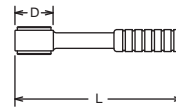

141 (mm)	D (mm)	L (mm)	(g)	(pce.)
6	28	205	215	1
8	28	205	215	1
10	32	205	234	1
12	32	205	233	1

141 (inch)	D (mm)	L (mm)	(g)	(pce.)
5/16	28	205	215	1
3/8	32	205	234	1
1/2	32	205	233	1

**141** Stud Puller Ratchets  
Extractores de Espárragos de Carraca

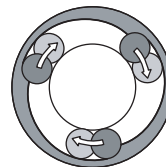

**Stud Puller Ratchet (141S/141/141P)**  
The three roller system can protect the studs from damage.

El sistema de tres rodillos puede proteger los espárragos de cualquier daño

**141P** Stud Puller Ratchets  
Extractores de Espárragos de Carraca

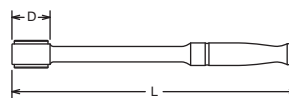

141P (mm)	D (mm)	L (mm)	(g)	(pce.)
6	28	205	210	1
8	28	205	210	1
10	32	205	229	1
12	32	205	227	1

**1201** 4 Pieces Set/△=973g  
METAL CASE:W240×H100×T32mm  
Pullers

**141S** Stud Puller Ratchets  
6, 8, 10, 12



**1201** Stud Puller Ratchets Set  
Juego de Extractores de Espárragos de Carraca





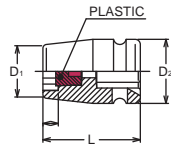

HAND MANUALES  
Z-SERIES  
TITANIUM DE TITANIO  
ACCESSORIES ACCESORIOS  
SCREWDRIVERS DESTORNILLADORES  
IMPACT DE IMPACTO  
SLEEVE-DRIVE INDUSTRIAL INDUSTRIALES  
AUTOMOTIVE  
CONSTRUCTION CONSTRUCCION  
RENEWAL KITS JUEGOS DE PIEZAS REPUESTO

HAND MANUALES  
Z-SERIES  
TITANIUM DE TITANIO  
ACCESSORIES ACCESORIOS  
SCREWDRIVERS DESTORNILLADORES  
IMPACT DE IMPACTO  
SLEEVE-DRIVE  
INDUSTRIAL INDUSTRIALES  
AUTOMOTIVE  
CONSTRUCTION CONSTRUCCION  
RENEWAL KITS JUEGOS DE PIEZAS/REPLUESTO

**BD14400MJ**  6-point Sockets for Anchor Screws  
Vasos Hexagonales para Pernos de Anclaje





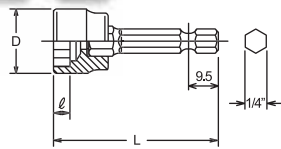

BD-4400MJ (mm)		D <sub>1</sub> (mm)	D <sub>2</sub> (mm)	(mm)	L (mm)	 (g)	 (pcs.)	
13	1/2"	20.7	25	5	38	140	10	*1
15		23.2	30	5	38	145	10	*2
16		24.5	30	6.5	38	145	10	*2
17		25.7	30	6.5	38	145	10	*2
19		28.2	30	7.5	38	145	10	*2
21		30.7	30	9	38	185	10	*2
24		34.5	30	10.5	38	190	10	*2

\*1 C-Ring=1401C, Pin/O-Ring=1401A/B  
\*2 C-Ring=1402C, Pin/O-Ring=1402A/B [P232-233](#)

**BD016E**  6-point Sockets for Anchor Screws  
**BD016E (SF)** 





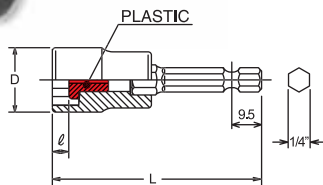

BD016E (mm)	D (mm)	(mm)	L (mm)	 (g)	 (pcs.)
13	19.5	4	50	43	10
17	24.5	5	50	56	10
19	27	6	50	68	10

BD016E (mm)	D (mm)	(mm)	L (mm)	 (g)	 (pcs.)
13SF	19.5	4	50	43	10
17SF	24.5	5	50	56	10
19SF	27	6	50	68	10

**BD016JE**  6-point Sockets for Anchor Screws  
**BD016JE (SF)** 



BD016JE (mm)	D (mm)	(mm)	L (mm)	 (g)	 (pcs.)
13	19.5	5	60	66	10
17	24.5	6.5	60	80	10
19	27	7.5	60	90	10

BD016JE (mm)	D (mm)	(mm)	L (mm)	 (g)	 (pcs.)
13SF	19.5	5	60	66	10
17SF	24.5	6.5	60	80	10
19SF	27	7.5	60	90	10

HAND  
MANUALES  
Z-SERIES  
TITANIUM  
DE TITANIO  
ACCESSORIES  
ACCESORIOS  
SCREWDRIVERS  
DESTORNILLADORES  
IMPACT  
DE IMPACTO  
SLEEVE-DRIVE  
INDUSTRIAL  
INDUSTRIALES  
AUTOMOTIVE  
CONSTRUCTION  
CONSTRUCCION  
RENEWAL KITS  
JUEGOS DE PIEZAS REPUESTO

HA001	D (mm)	(mm)	L (mm)	(g)	(pcs.)
10(1.5)	15.5	13	47	90	10
12(1.25)	17.2	15	49	100	10
16(2.0)	21	18	52	125	10
20(2.5)	24.5	21	56	155	10
22(2.5)	26.5	27	61	175	10
24(3.0)	28	28	62	185	10
W3/8	14.8	13	47	90	10
W1/2	17.6	15	49	105	10

**HA001** Stud Setters  
Vasos para Atornillar Espárragos

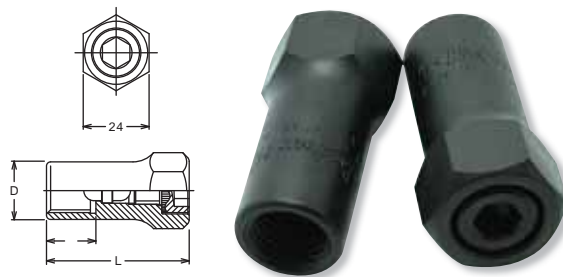

HA002.130 (mm)	D (mm)	(mm)	L (mm)	(g)	(pcs.)
24	34.5	14	130	246	10

HA002.160 (mm)	D (mm)	(mm)	L (mm)	(g)	(pcs.)
24	34.5	14	160	465	10

**HA002-130 · -160** Socket for HA001  
Vaso para HA001

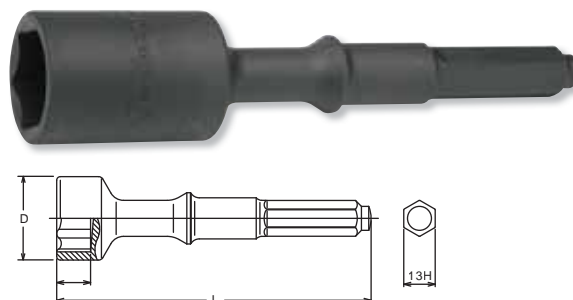

HA003.100 (mm)	D (mm)	(mm)	L (mm)	(g)	(pcs.)
24	34.5	14	100	155	10

**HA003-100** Socket for HA001  
Vaso para HA001

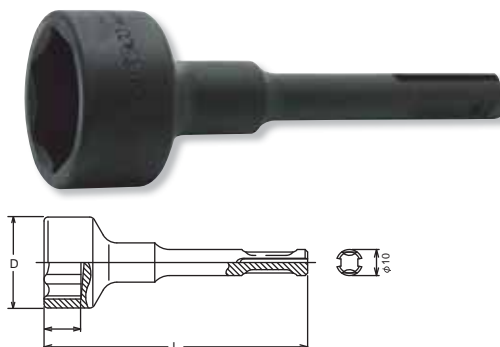

HA004 (mm)	D (mm)	(mm)	L (mm)	(g)	(pcs.)
24	31	16.5	58	91	10

**HA004**

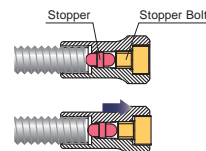
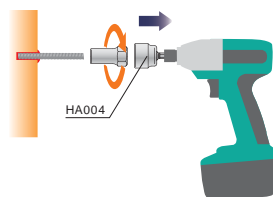
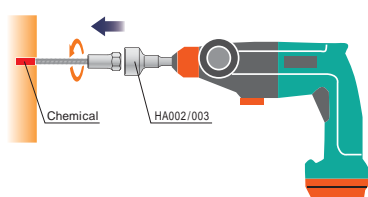
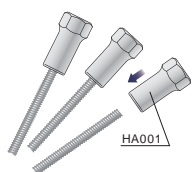
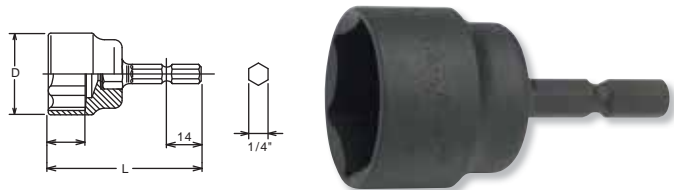

HAND  
MANUALES

Z-SERIES

TITANIUM  
DE TITANIO

ACCESSORIES  
ACCESORIOS

SCREWDRIVERS  
DESTORNILLADORES

IMPACT  
DE IMPACTO

SLEEVE-DRIVE

INDUSTRIAL  
INDUSTRIALES

AUTOMOTIVE

CONSTRUCTION  
CONSTRUCCION

RENEWAL KITS  
JUEGOS DE PIEZAS REPLUSTO

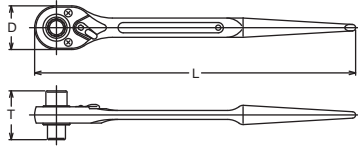

**170S**  Spud Handle Ratchets  
Llaves de Carraca con Mango de Cola



170S (mm)	D (mm)	T (mm)	L (mm)	 (g)	 (pce.)
10x12	34	38	250	260	1
12x14	34	38	250	260	1

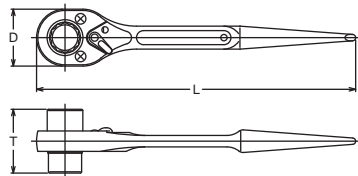

**171S**  Spud Handle Ratchets(Short)  
Llaves de Carraca con Mango de Cola(Cortas)



171S (mm)	D (mm)	T (mm)	L (mm)	 (g)	 (pce.)
14x17	44.6	50	250	460	1
17x19	44.6	50	250	460	1
17x21	44.6	50	250	460	1
19x21	44.6	50	250	460	1

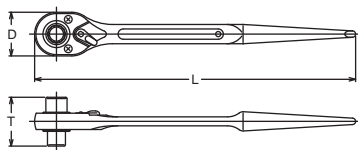

**171**  Spud Handle Ratchets(Long)  
Llaves de Carraca con Mango de Cola(Largas)

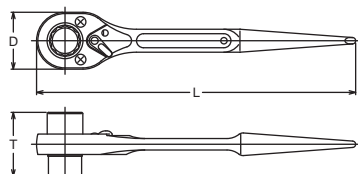

171 (mm)	D (mm)	T (mm)	L (mm)	 (g)	 (pce.)
14x17	44.6	50	380	630	1
17x19	44.6	50	380	630	1
17x21	44.6	50	380	630	1
19x21	44.6	50	380	630	1

**172**  Spud Handle Ratchets  
Llaves de Carraca con Mango de Cola



172 (mm)	D (mm)	T (mm)	L (mm)	 (g)	 (pce.)
21x26	68	58	380	1100	1
22x24	68	58	380	1100	1
23x26	68	58	380	1100	1
24x27	68	58	380	1100	1
26x32	68	63	380	1100	1

**171SB-1/2** Spud Handle Ratchet with Push Button(short)  
Llave de Carraca con Mango de Cola con Botón(corta)



		D (mm)	T (mm)	L (mm)	(g)	(pce.)
171SB-1/2	1/2"	44.6	33	250	480	1

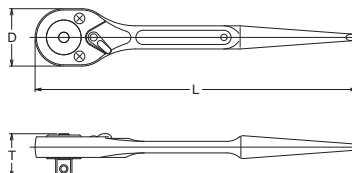

**171B-1/2** Spud Handle Ratchet with Push Button(Long)  
Llave de Carraca con Mango de Cola con Botón(larga)



		D (mm)	T (mm)	L (mm)	(g)	(pce.)
171B-1/2	1/2"	44.6	33	380	650	1

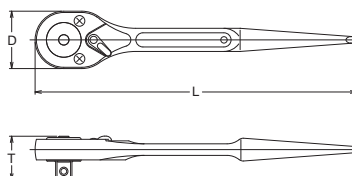

**4300TW** 6-point Sockets  
Vasos Hexagonales

4300TW (mm)		D <sub>1</sub> (mm)	D <sub>2</sub> (mm)	(mm)	L (mm)	(g)	(pcs.)
14	1/2"	20.3	21	15	77	120	10
17		24	21.8	18	77	130	10
19		26.5	21.8	20	77	150	10
21		29	21.8	23	77	150	10

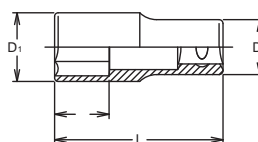

**1205** Set  
Juego



1205		5 Pieces Set/△=1,200g	
BAG			
Sockets		Accessory	
	4300TW Sockets 14, 17, 19, 21	171B-1/2	

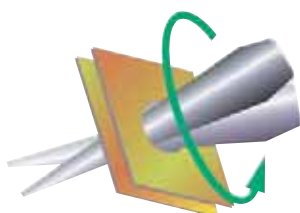

HAND MANUALES  
Z-SERIES  
TITANIUM DE TITANIO  
ACCESSORIES ACCESORIOS  
SCREWDRIVERS DESTORNILLADORES  
IMPACT DE IMPACTO  
SLEEVE-DRIVE INDUSTRIAL INDUSTRIALES  
AUTOMOTIVE  
CONSTRUCTION CONSTRUCCION  
RENEWAL KITS JUEGOS DE PIEZAS REPIESTO





Ko-ken welcomes customer enquiries for special tools. New items can be designed and manufactured according to customers requirements. Please enquire through your distributors.

Ko-ken da la bienvenida a todas las solicitudes por herramientas especiales de nuestros clientes. Productos nuevos pueden ser diseñados y fabricados de acuerdo a sus necesidades. Por favor haga su solicitud a través nuestra red de distribuidores.

## Plastic Protector

Plastic Protector helps to prevent Scratching working surfaces.



# Renewal Kits



HAND  
MANUALES

Z-SERIES

TITANIUM  
DE TITANIO

ACCESSORIES  
ACCESORIOS

SCREWDRIVERS  
DESTORNILLADORES

IMPACT  
DE IMPACTO

SLEEVE-DRIVE

INDUSTRIAL  
INDUSTRIALES

AUTOMOTIVE

CONSTRUCTION  
CONSTRUCCION

RENEWAL KITS  
JUEGOS DE PIEZAS REPLETO

**2749RK**



**2752RK** 2752N



**2753RK** 2753N, 2753PS, 2753P, 2753P-160, 2753J, 2774PS, 2774JS, 2774N, 2774P, 2774J



**2753BRK** 2753NB, 2753PB, 2753JB



**2725RK** 2725Z, 2726Z



**2749RK-3/8** 2749PS-3/8, 2749N-3/8, 2749P-3/8, 2774PS-3/8, 2774JS-3/8



**3749RK** 3749S, 3749N



**3749BRK** 3749SB



**3752RK** 3752N, 3752J, 3757, 3776N, 3776P, 3776J



**3753RK** 3753SM, 3753N, 3753P, 3753P-250, 3753J, 3774PS, 3774D-SR, D3753J, 3774N, 3774P, 3774J, 3774NL, 3774PL, 3774JL



**3753BRK** 3753SMB, 3753NB, 3753PB, 3753JB, 3774NB, 3774PB, 3774JB, 3774JBL

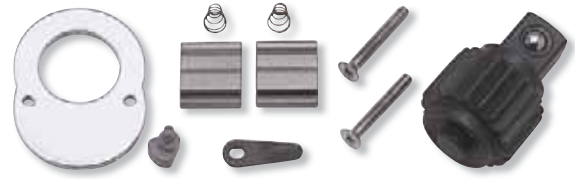

**3725RK** 3725Z, 3725ZS, 3726Z, 3726ZS



**168T-6IP(40)** TORXPlus® 6IP Screwdriver for 2725RK

**168T-8IP(40)** TORXPlus® 8IP Screwdriver for 3725RK



	□	⚖️ (g)	📦 (pce.)
		30	1
		42	1
	1/4"	30	1
		31	1
New		30	1
		45	1
		70	1
		84	1
	3/8"	84	1
		76	1
		77	1
New		50	1
New	—	20	1
New	—	20	1



HAND  
MANUALES

Z-SERIES

TITANIUM  
DE TITANIO

ACCESSORIES  
ACCESORIOS

SCREWDRIVERS  
DESTORNILLADORES

IMPACT  
DE IMPACTO

SLEEVE-DRIVE

INDUSTRIAL  
INDUSTRIALES

AUTOMOTIVE

CONSTRUCTION  
CONSTRUCCION

RENEWAL KITS  
JUEGOS DE PIEZAS REPUESTO

**3749SRK-1/2** 3749S-1/2



**3749SBRK-1/2** 3749SB-1/2



**4749RK** 4749N-250  
4749N-380, 4749J-380



**4750RK** 4750N, 4750P, 4750J



**4750BRK** 4750NB, 4750PB, 4750JB



**4752RK** 4752N, 4752J



**4753RK** 4753N, 4753P, 4753P-410, 4753J, D4753J  
4774N, 4774P, 4774P-450, 4774J



**4753BRK** 4753NB, 4753PB, 4753JB  
4774NB, 4774PB, 4774JB



**6749RK** 6749, 6749-1000



**6752RK** 6752



**8749RK** 8749



	□	⚖ (g)	📦 (pce.)	
3749SRK-1/2	1/2"	120	1	
3749SBRK-1/2		120	1	
4749RK		130	1	
4750RK		130	1	
4750BRK		130	1	
4752RK		140	1	
4753RK		130	1	
4753BRK		130	1	
6749RK		3/4"	580	1
6752RK			600	1
8749RK	800		1	

HAND  
MANUALES

Z-SERIES

TITANIUM  
DE TITANIO

ACCESSORIES  
ACCESORIOS

SCREWDRIVERS  
DESTORNILLADORES

IMPACT  
DE IMPACTO

SLEEVE-DRIVE

INDUSTRIAL  
INDUSTRIALES

AUTOMOTIVE

CONSTRUCTION  
CONSTRUCCION

RENEWAL KITS  
JUEGOS DE PIEZAS REPLIESO

### 2755RK



### 3755RK



### 4755RK



### 6755RK



	□	⚖ (g)	📦 (pce.)
2755RK	1/4"	40	1
3755RK	3/8"	98	1
4755RK	1/2"	137	1
6755RK	3/4"	550	1

### 2768RK 2768N, 2768P, 2768J



### 3768RK 3768N, 3768P, 3768J 3768ZRK 3768Z



### 4768RK 4768N, 4768P, 4768J, 4781N-450



### 6768RK 6768



### 8768RK 8768



	□	⚖ (g)	📦 (pce.)
2768RK	1/4"	9	1
3768RK	3/8"	21	1
<b>NEW</b> 3768ZRK	3/8"	21	1
4768RK	1/2"	60	1
6768RK	3/4"	175	1
8768RK	1"	475	1



### 3112RK



		(pce.)
3112RK	3/8"	1
4112RK	1/2"	1
6112RK	3/4"	1

### 4112RK



### 6112RK



### 4100MRK 4100ARK



4100MRK (mm)		(pce.)
6	1/2"	1
7		1
8		1
9		1
10		1
10.5		1
11		1
12		1
14		1
16		1

4100ARK (inch)		(pce.)
1/4	1/2"	1
5/16		1
3/8		1
7/16		1
1/2		1
9/16		1
5/8		1

6100MRK (mm)		(pce.)
18	3/4"	1
20		1
22		1
24		1
27		1
28		1
29		1
30		1

		(pce.)
162RK		1
New	5/16	1
New	3/8	1
New	1/2	1
New	10	1

### 6100MRK



### 162RK



# HAND SOCKETS / Diameter of Bore

Standard Socket



Deep Socket

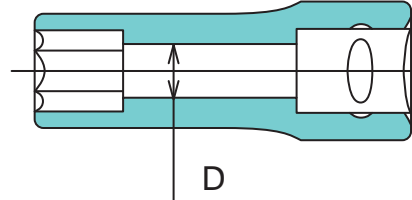
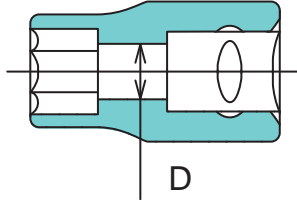

SOCKET		1/4" $\varnothing$		3/8" $\varnothing$		1/2" $\varnothing$		3/4" $\varnothing$		1" $\varnothing$
		Standard	Deep	Standard	Deep	Standard	Deep	Standard	Deep	Standard
		2400M 2400A	2300M 2300A	3400M 3400A	3300M 3300A	4400M 4400A	4300M 4300A	6400M 6400A	6300M 6300A	8400M 8400A
		2405M 2405A	2305M 2305A	3405M 3405A	3305M 3305A	4405M 4405A	4305M 4305A	6405M 6405A	6305M 6305A	8405M 8405A
(mm)	(inch)	D								
3	1/8	2.5	2.5							
4		3.5	3.5							
4.5		4	4							
5	3/16	4	4.5							
5.5	7/32	4.5	5	4.5	5					
6	1/4	5	5	5	5					
7	9/32	5.5	6	5.5	6					
8	5/16	6	7	6	7	6	7			
9	11/32	7	8	7	8	7	8			
10	3/8	8	9	8	9	8	9			
11	7/16	9	10	9	10	9	10			
12		10	11	10	11	10	11			
13	1/2	11	12	11	12	11	12			
14	9/16	12	13	12	13	12	13			
15	19/32			13	14	13	14			
16	5/8			14	15	14	15			
17	21/32			15	16	15	16	15	16	
18	11/16			15	17	15	17	15	17	
19	3/4			16	18	16	18	16	18	
20	25/32			17	19	17	19	17	19	
21	13/16			18	20	18	20	18	20	
22	7/8			19	21	19	21	19	21	
23				20	22	20	22	20	22	
24	15/16			21	23	21	23	21	23	
25						22	24	22	24	
26	1					23	25	23	25	
27	1- 1/16					23	26	23	26	23
28						24	27	24	27	24
29	1- 1/8					24	28	24	28	24
30	1- 3/16					25	29	25	29	25
31						26	30	26	30	26
32	1- 1/4					27	31	27	31	27
33	1- 5/16							28	32	28
34								29	33	29
35	1- 3/8							30	34	30
36								31	35	31
37	1- 7/16							31	36	31
38	1- 1/2							32	37	32
39								32	38	32
40	1- 9/16							33	39	33
41	1- 5/8							34	40	34
42								34	41	34
43	1-11/16							35	42	35
44	1- 3/4							36	43	36
45								36	44	36
46	1-13/16							37	45	37
47								38	46	38
48	1- 7/8							38	47	38
	1-15/16							39	48	39
50	2							40	49	40
	2- 1/16							40		

Standard Socket

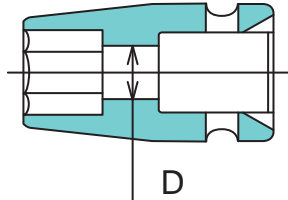

Deep Socket

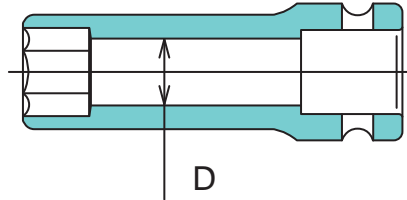

SOCKET		1/4" Ø		3/8" Ø		1/2" Ø		3/4" Ø		1" Ø	
		Standard	Standard	Deep	Standard	Deep	Standard	Deep	Standard	Deep	
Ø		12400M 12400A	13400M 13400A	13300M 13300A	14400M 14400A	14300M 14300A	16400M 16400A	16300M 16300A	18400M 18400A	18300M 18300A	
(mm)	(inch)	D									
4		3									
4.5	3/16	3									
5		4									
5.5		4									
6	1/4	5	5	5							
7	9/32	5	5	6							
8	5/16	6	6	7	6	7					
9	11/32	7	7	8	7	8					
10	3/8	8	8	9	8	9					
11	7/16	9	9	10	9	10					
12		10	10	11	10	11					
13	1/2	11	11	12	11	12					
14	9/16	12	12	13	12	13					
15			13	14	13	14					
16	5/8		14	15	14	15					
17	11/16		14	16	14	16	14	16			
18			15	17	15	17	15	17			
19	3/4		16	18	16	18	16	18	16	18	
20			17	19	17	19	17	19	17	19	
21	13/16		18	20	18	20	18	20	18	20	
22	7/8		19	21	19	21	19	21	19	21	
23			20		20	22	20	22	20	22	
24	15/16				21	23	21	23	21	23	
25	1				22	24	22	24	22	24	
26					23	25	23	25	23	25	
27	1- 1/16				23	26	23	26	23	26	
28					24	27	24	27	24	27	
29	1- 1/8				25	28	25	28	25	28	
30	1- 3/16				26	29	26	29	26	29	
31					27	30	27	30	27	30	
32	1- 1/4				28	31	28	31	28	31	
33							29	32	29	32	
34	1- 5/16						30	33	30	33	
35	1- 3/8						31	34	31	34	
36							32	35	32	35	
37	1- 7/16						32	36	32	36	
38	1- 1/2						34	37	34	37	
40	1- 9/16						34	39	34	39	
41	1- 5/8						35	40	35	40	
42	1-11/16						35	41	35	41	
45	1- 3/4						35	44	35	44	
46	1-13/16						40	45	40	45	
47							40	46			
	1- 7/8						40	47			







# Socket Screw Data Chart

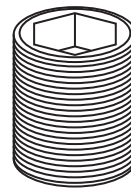
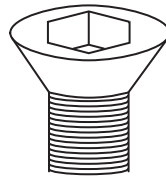
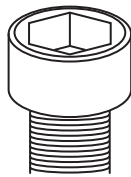
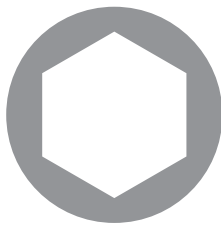



METRIC Sizes				
SW nominal size of wrench (mm)	Socket Head Cap Screws	Socket Button Head Screws	Socket Head Shoulder Screws	Socket Set Screws
	ISO4762	ISO7380	ISO7379	ISO 4026,4027 4028,4029
0.7	-	-	-	M1.4
				M1.6
				M1.8
0.9	-	-	-	M2
1.3	M1.4	-	-	M2.5
1.5	M1.6 M2	-	-	M3
2	M2.5	M3	M3	M4
2.5	M3	M4	M4	M5
3	M4	M5	M5	M6
4	M5	M6	M6	M8
5	M6	M8	M8	M10
6	M8	M10	M10	M12 M14
7	-	-	-	-
8	M10	M12	M12	M16
10	M12	M16	M16	M20
12	M14	-	M20	M24
14	M16	-	-	-
17	M20	-	-	-
19	M24	-	-	-
22	M30	-	-	-
24	M33	-	-	-
27	M36	-	-	-



SW nominal size of wrench	AMERICAN Sizes				BRITISH Sizes				
	(inch)	(mm)	ANSI B 18.3 : 1986		BS 2470 : 1973				
			Cap Screws 1960 series	Flat and Button Head Cap Screws	Shoulder Screws	Set Screws	Cap Screws	Flat and Button Head Cap Screws	Shoulder Screws
.028 dec. in.	0.7	-	-	-	No.0 No.1	-	-	-	No.0
.035 dec. in.	0.9	-	No.0	-	No.2	-	No.0	-	No.1 No.2
.050 dec. in.	1.3	No.0	No.1 No.2	-	No.3 No.4	No.0 No.1	No.1 No.2	-	No.3 No.4 6 BA
1/16	1.59	No.1	No.3 No.4	-	No.5 No.6	No.2	No.3 No.4	-	No.5 No.6 4 BA 5 BA
5/64	1.98	No.2 No.3	No.5 No.6	-	No.8	No.3 No.4 6 BA	No.5 No.6	-	No.8 3 BA
3/32	2.38	No.4 No.5	No.8	-	No.10	No.5 No.6 4 BA 5 BA	No.8	-	No.10 1 BA 2 BA 3/16
7/64	2.78	No.6	-	-	-	-	-	-	-
1/8	3.18	-	No.10	1/4	1/4	No.8 3 BA	No.10	1/4	0 BA 1/4
9/64	3.57	No.8	-	-	-	-	-	-	-
5/32	3.97	No.10	1/4	5/16	5/16	No.10 1 BA 2 BA 3/16	1/4	5/16	5/16
3/16	4.76	1/4	5/16	3/8	3/8	0 BA 1/4	5/16	3/8	BSPF1/8 3/8
7/32	5.56	-	3/8	-	7/16	5/16	3/8	-	7/16
1/4	6.35	5/16	7/16	1/2	1/2	-	7/16	1/2	BSPF1/4 1/2
5/16	7.94	3/8	1/2	5/8	5/8	3/8 7/16	1/2	5/8	BSPF3/8 5/8
3/8	9.53	7/16 1/2	5/8	3/4	3/4	1/2	5/8	3/4	BSPF1/2 3/4
			Only Flat Head						
1/2	12.7	5/8	3/4	1	7/8	5/8	3/4	-	BSPF5/8 7/8
9/16	14.29	-	7/8	-	1 1 1/8	3/4 7/8	-	-	BSPF3/4 1
5/8	15.88	3/4	1	1 1/4	1 1/4 1 3/8	1	-	-	-
3/4	19.05	7/8 1	1 1/8	-	1 1/2	-	-	-	-
7/8	22.23	1 1/8 1 1/4	1 1/4 1 3/8	1 1/2	-	-	-	-	-
1	25.4	1 3/8 1 1/2	1 1/2	1 3/4	1 3/4 2	-	-	-	-

# TORX® / TORX<sup>plus</sup>® / PENTA-LOBE / LHSTIX® / XZN / Ribe CV Data Chart

## TORX® / TORX<sup>plus</sup>® BITS

			S
T6	6IP		1.6
T7	7IP		2.0
T8	8IP		2.3
T9	9IP		2.5
T10	10IP		2.7
T15	15IP		3.3
T20	20IP		3.8
T25	25IP		4.4
T27	27IP		5.0
T30	30IP		5.5
T40	40IP		6.6
T45	45IP		7.8
T50	50IP		8.8
T55	55IP		11.2
T60	60IP		13.2
T70	70IP		15.5
T80	80IP		17.5
T90	90IP		19.9
T100	100IP		22.1

## TORX® / TORX<sup>plus</sup>® SOCKETS

		S
E4	4EP	3.8
E5	5EP	4.7
E6	6EP	5.7
E7	7EP	6.2
E8	8EP	7.5
E10	10EP	9.4
E11	11EP	10.0
E12	12EP	11.1
E14	14EP	12.9
E16	16EP	14.7
E18	18EP	16.6
E20	20EP	18.4
E22	22EP	20.2
E24	24EP	22.1
E26	26EP	23.9
E28	28EP	25.7
E30	30EP	27.4
E32	32EP	29.2

## PENTA-LOBE BITS

	S
8PR	2.2
9PR	2.4
10PR	2.6
15PR	3.1
20PR	3.6
25PR	4.1
27PR	4.7
30PR	5.2
40PR	6.3
45PR	7.4
50PR	8.4
55PR	10.6

## LHSTIX® (LH-S) SOCKETS

	S
LH3S	3.8
LH4S	4.5
LH5S	5.6
LH6S	6.8
LH7S	7.9
LH8S	9.0
LH10S	11.3
LH12S	13.6
LH14S	15.8
LH16S	18.1

## XZN BITS

	S
M4	3.6
M5	4.8
M6	6.0
M8	7.2
M10	9.6
M12	11.4
M14	13.2
M16	15.6
M18	16.9

## Ribe CV BITS

	S	W
M5	5.0	1.1
M6	6.0	1.3
M7	7.0	1.4
M8	8.0	1.7
M9	9.0	1.9
M10	10.0	2.2
M12	12.0	2.6
M13	13.0	3.0
M14	14.0	3.1
M16	16.0	3.5



Conversion Table: American Inches-Decimal Inches-Millimeter

		0"	1"	2"	3"	4"	5"	6"	7"	8"	9"	10"	11"
in	dec.in.	Millimeter(mm)											
1/64	0.01563	0	25.4000	50.8000	76.2000	101.6000	127.0000	152.4000	177.8000	203.2000	228.6000	254.0000	279.4000
1/32	0.03125	0.3969	25.7969	51.1969	76.5969	101.9969	127.3969	152.7969	178.1969	203.5969	228.9969	254.3969	279.7969
3/64	0.04688	1.1906	26.5906	51.9906	77.3906	102.7906	128.1906	153.5906	178.9906	204.3906	229.7906	255.1906	280.5906
1/16	0.06250	1.5875	26.9875	52.3875	77.7875	103.1875	128.5875	153.9875	179.3875	204.7875	230.1875	255.5875	280.9875
5/64	0.07813	1.9844	27.3844	52.7844	78.1844	103.5844	128.9844	154.3844	179.7844	205.1844	230.5844	255.9844	281.3844
3/32	0.09375	2.3813	27.7813	53.1813	78.5813	103.9813	129.3813	154.7813	180.1813	205.5813	230.9813	256.3813	281.7813
7/64	0.10938	2.7781	28.1781	53.5781	78.9781	104.3781	129.7781	155.1781	180.5781	205.9781	231.3781	256.7781	282.1781
1/8	0.12500	3.1750	28.5750	53.9750	79.3750	104.7750	130.1750	155.5750	180.9750	206.3750	231.7750	257.1750	282.5750
9/64	0.14063	3.5719	28.9719	54.3719	79.7719	105.1719	130.5719	155.9719	181.3719	206.7719	232.1719	257.5719	282.9719
5/32	0.15625	3.9688	29.3688	54.7688	80.1688	105.5688	130.9688	156.3688	181.7688	207.1688	232.5688	257.9688	283.3688
11/64	0.17188	4.3656	29.7656	55.1656	80.5656	105.9656	131.3656	156.7656	182.1656	207.5656	232.9656	258.3656	283.7656
3/16	0.18750	4.7625	30.1625	55.5625	80.9625	106.3625	131.7625	157.1625	182.5625	207.9625	233.3625	258.7625	284.1625
13/64	0.20313	5.1594	30.5594	55.9594	81.3594	106.7594	132.1594	157.5594	182.9594	208.3594	233.7594	259.1594	284.5594
7/32	0.21875	5.5563	30.9563	56.3563	81.7563	107.1563	132.5563	157.9563	183.3563	208.7563	234.1563	259.5563	284.9563
15/64	0.23438	5.9531	31.3531	56.7531	82.1531	107.5531	132.9531	158.3531	183.7531	209.1531	234.5531	259.9531	285.3531
1/4	0.25000	6.3500	31.7500	57.1500	82.5500	107.9500	133.3500	158.7500	184.1500	209.5500	234.9500	260.3500	285.7500
17/64	0.26563	6.7469	32.1469	57.5469	82.9469	108.3469	133.7469	159.1469	184.5469	209.9469	235.3469	260.7469	286.1469
9/32	0.28125	7.1438	32.5438	57.9438	83.3438	108.7438	134.1438	159.5438	184.9438	210.3438	235.7438	261.1438	286.5438
19/64	0.29688	7.5406	32.9406	58.3406	83.7406	109.1406	134.5406	159.9406	185.3406	210.7406	236.1406	261.5406	286.9406
5/16	0.31250	7.9375	33.3375	58.7375	84.1375	109.5375	134.9375	160.3375	185.7375	211.1375	236.5375	261.9375	287.3375
21/64	0.32813	8.3344	33.7344	59.1344	84.5344	109.9344	135.3344	160.7344	186.1344	211.5344	236.9344	262.3344	287.7344
11/32	0.34375	8.7313	34.1313	59.5313	84.9313	110.3313	135.7313	161.1313	186.5313	211.9313	237.3313	262.7313	288.1313
23/64	0.35938	9.1281	34.5281	59.9281	85.3281	110.7281	136.1281	161.5281	186.9281	212.3281	237.7281	263.1281	288.5281
3/8	0.37500	9.5250	34.9250	60.3250	85.7250	111.1250	136.5250	161.9250	187.3250	212.7250	238.1250	263.5250	288.9250
25/64	0.39063	9.9219	35.3219	60.7219	86.1219	111.5219	136.9219	162.3219	187.7219	213.1219	238.5219	263.9219	289.3219
13/32	0.40625	10.3188	35.7188	61.1188	86.5188	111.9188	137.3188	162.7188	188.1188	213.5188	238.9188	264.3188	289.7188
27/64	0.42188	10.7156	36.1156	61.5156	86.9156	112.3156	137.7156	163.1156	188.5156	213.9156	239.3156	264.7156	290.1156
7/16	0.43750	11.1125	36.5125	61.9125	87.3125	112.7125	138.1125	163.5125	188.9125	214.3125	239.7125	265.1125	290.5125
29/64	0.45313	11.5094	36.9094	62.3094	87.7094	113.1094	138.5094	163.9094	189.3094	214.7094	240.1094	265.5094	290.9094
15/32	0.46875	11.9063	37.3063	62.7063	88.1063	113.5063	138.9063	164.3063	189.7063	215.1063	240.5063	265.9063	291.3063
31/64	0.48438	12.3031	37.7031	63.1031	88.5031	113.9031	139.3031	164.7031	190.1031	215.5031	240.9031	266.3031	291.7031
1/2	0.50000	12.7000	38.1000	63.5000	88.9000	114.3000	139.7000	165.1000	190.5000	215.9000	241.3000	266.7000	292.1000
33/64	0.51563	13.0969	38.4969	63.8969	89.2969	114.6969	140.0969	165.4969	190.8969	216.2969	241.6969	267.0969	292.4969
17/32	0.53125	13.4938	38.8938	64.2938	89.6938	115.0938	140.4938	165.8938	191.2938	216.6938	242.0938	267.4938	292.8938
35/64	0.54688	13.8906	39.2906	64.6906	90.0906	115.4906	140.8906	166.2906	191.6906	217.0906	242.4906	267.8906	293.2906
9/16	0.56250	14.2875	39.6875	65.0875	90.4875	115.8875	141.2875	166.6875	192.0875	217.4875	242.8875	268.2875	293.6875
37/64	0.57813	14.6844	40.0844	65.4844	90.8844	116.2844	141.6844	167.0844	192.4844	217.8844	243.2844	268.6844	294.0844
19/32	0.59375	15.0813	40.4813	65.8813	91.2813	116.6813	142.0813	167.4813	192.8813	218.2813	243.6813	269.0813	294.4813
39/64	0.60938	15.4781	40.8781	66.2781	91.6781	117.0781	142.4781	167.8781	193.2781	218.6781	244.0781	269.4781	294.8781
5/8	0.62500	15.8750	41.2750	66.6750	92.0750	117.4750	142.8750	168.2750	193.6750	219.0750	244.4750	269.8750	295.2750
41/64	0.64063	16.2719	41.6719	67.0719	92.4719	117.8719	143.2719	168.6719	194.0719	219.4719	244.8719	270.2719	295.6719
21/32	0.65625	16.6688	42.0688	67.4688	92.8688	118.2688	143.6688	169.0688	194.4688	219.8688	245.2688	270.6688	296.0688
43/64	0.67188	17.0656	42.4656	67.8656	93.2656	118.6656	144.0656	169.4656	194.8656	220.2656	245.6656	271.0656	296.4656
11/16	0.68750	17.4625	42.8625	68.2625	93.6625	119.0625	144.4625	169.8625	195.2625	220.6625	246.0625	271.4625	296.8625
45/64	0.70313	17.8594	43.2594	68.6594	94.0594	119.4594	144.8594	170.2594	195.6594	221.0594	246.4594	271.8594	297.2594
23/32	0.71875	18.2563	43.6563	69.0563	94.4563	119.8563	145.2563	170.6563	196.0563	221.4563	246.8563	272.2563	297.6563
47/64	0.73438	18.6531	44.0531	69.4531	94.8531	120.2531	145.6531	171.0531	196.4531	221.8531	247.2531	272.6531	298.0531
3/4	0.75000	19.0500	44.4500	69.8500	95.2500	120.6500	146.0500	171.4500	196.8500	222.2500	247.6500	273.0500	298.4500
49/64	0.76563	19.4469	44.8469	70.2469	95.6469	121.0469	146.4469	171.8469	197.2469	222.6469	248.0469	273.4469	298.8469
25/32	0.78125	19.8438	45.2438	70.6438	96.0438	121.4438	146.8438	172.2438	197.6438	223.0438	248.4438	273.8438	299.2438
51/64	0.79688	20.2406	45.6406	71.0406	96.4406	121.8406	147.2406	172.6406	198.0406	223.4406	248.8406	274.2406	299.6406
13/16	0.81250	20.6375	46.0375	71.4375	96.8375	122.2375	147.6375	173.0375	198.4375	223.8375	249.2375	274.6375	300.0375
53/64	0.82813	21.0344	46.4344	71.8344	97.2344	122.6344	148.0344	173.4344	198.8344	224.2344	249.6344	275.0344	300.4344
27/32	0.84375	21.4313	46.8313	72.2313	97.6313	123.0313	148.4313	173.8313	199.2313	224.6313	250.0313	275.4313	300.8313
55/64	0.85938	21.8281	47.2281	72.6281	98.0281	123.4281	148.8281	174.2281	199.6281	225.0281	250.4281	275.8281	301.2281
7/8	0.87500	22.2250	47.6250	73.0250	98.4250	123.8250	149.2250	174.6250	200.0250	225.4250	250.8250	276.2250	301.6250
57/64	0.89063	22.6219	48.0219	73.4219	98.8219	124.2219	149.6219	175.0219	200.4219	225.8219	251.2219	276.6219	302.0219
29/32	0.90625	23.0188	48.4188	73.8188	99.2188	124.6188	150.0188	175.4188	200.8188	226.2188	251.6188	277.0188	302.4188
59/64	0.92188	23.4156	48.8156	74.2156	99.6156	125.0156	150.4156	175.8156	201.2156	226.6156	252.0156	277.4156	302.8156
15/16	0.93750	23.8125	49.2125	74.6125	100.0125	125.4125	150.8125	176.2125	201.6125	227.0125	252.4125	277.8125	303.2125
61/64	0.95313	24.2094	49.6094	75.0094	100.4094	125.8094	151.2094	176.6094	202.0094	227.4094	252.8094	278.2094	303.6094
31/32	0.96875	24.6063	50.0063	75.4063	100.8063	126.2063	151.6063	177.0063	202.4063	227.8063	253.2063	278.6063	304.0063
63/64	0.98438	25.0031	50.4031	75.8031	101.2031	126.6031	152.0031	177.4031	202.8031	228.2031	253.6031	279.0031	304.4031
in.	dec.in.	12"	13"	14"	15"	16"	17"	18"	19"	20"	21"	22"	23"
		Millimeter(mm)											
1/32	0.03125	304.8000	330.2000	355.6000	381.0000	406.4000	431.8000	457.2000	482.6000	508.0000	533.4000	558.8000	584.2000
1/16	0.06250	305.5938	330.9938	356.3938	381.7938	407.1938	432.5938	457.9938	483.3938	508.7938	534.1938	559.5938	584.9938
3/32	0.09375	306.3875	331.7875	357.1875	382.5875	407.9875	433.3875	458.7875	484.1875	509.5875	534.9875	560.3875	585.7875
1/8	0.12500	307.1813	332.5813	357.9813	383.3813	408.7813	434.1813	459.5813	484.9813	510.3813	535.7813	561.1813	586.5813
5/32	0.15625	30											

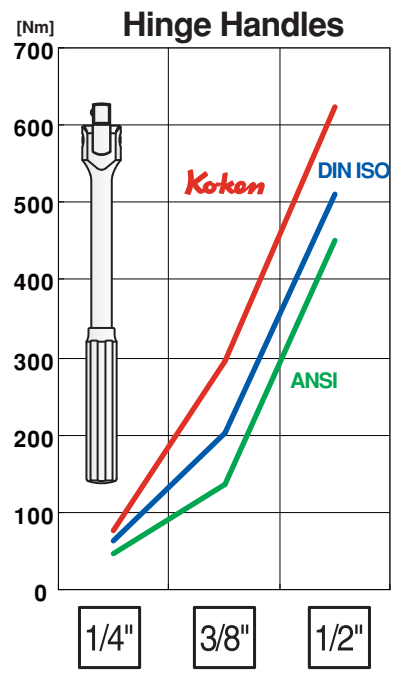
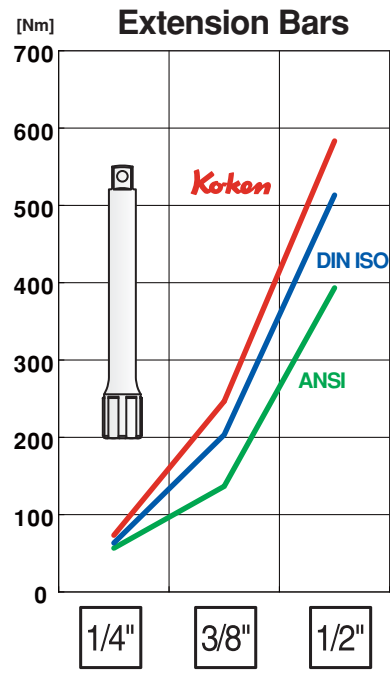
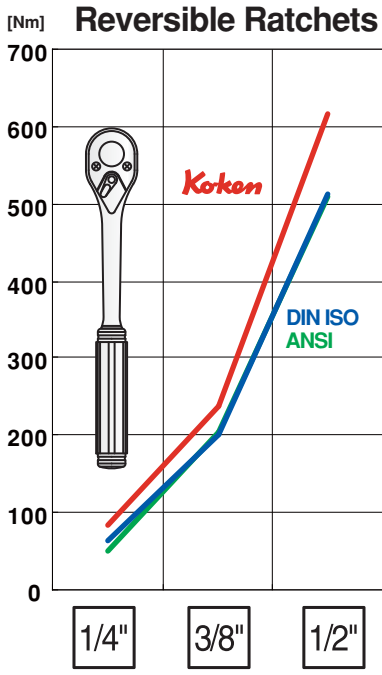
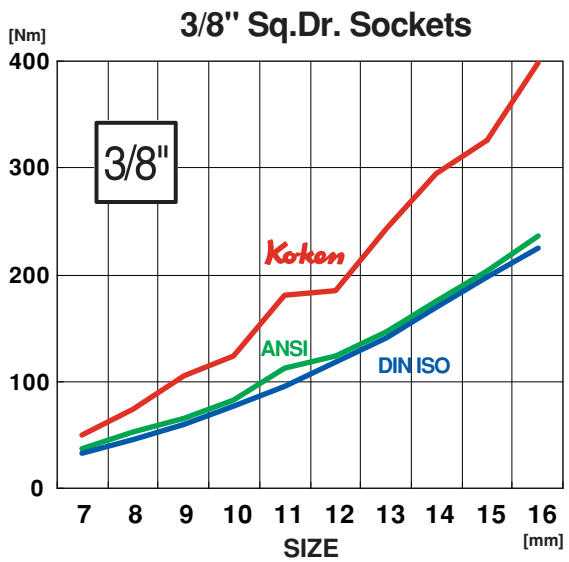
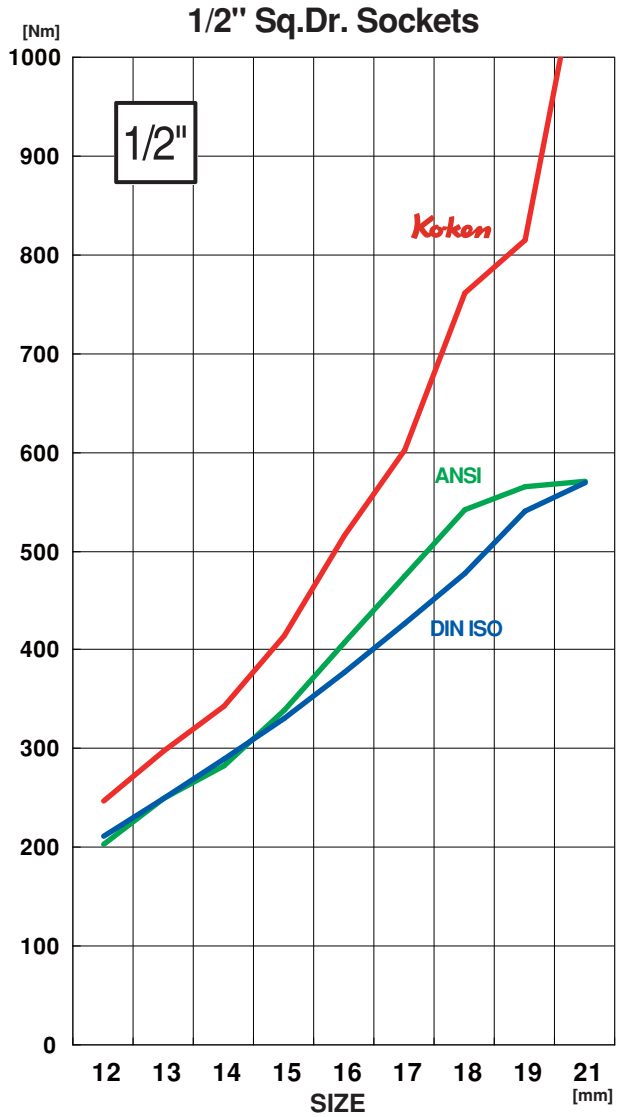
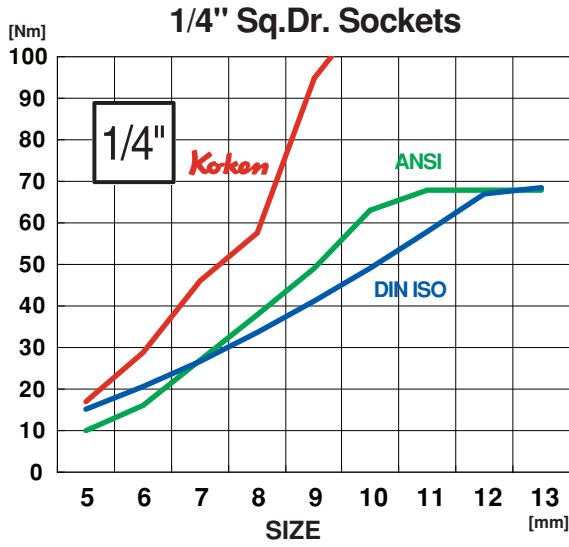

# Numerical Index

10099A	224	123PN	159,267	13430M	179	14400A	185
100H	154	123PT	159	13440A	179	14400M	185
100P	154	12400A	170	13440M	179	14400MG	187
100P (PZ)	154	12400AG	170	13440T	179	14400-WN	188
100S	154	12400M	170	13460A	176	14401A	186
100T (T)	154	12400MG	170	13460AG	176	14401LH	187
100T (TH)	154	12410M	170	13460M	176	14401M	186
100X (XZN)	154	12425	171	13460MG	176	14405A	185
101A	149	12460A	171	13465M	175	14405M	185
101B	148	12460AG	171	135E	157	14406A	186
101H	148	12460M	171	137	146	14406M	186
101P	148	12460MG	171	13760	183	14410M	187
101S	148	12465M	171	13770	184	14415M	188
101T (T)	148	124M (2B)	139	13771	184	14425	188
101T (TH)	148	12760	172	13772-P	184,253	14425-EPL	188
102KA	144	12770	172	138	146	14433A	198
102KM	144	127C	243	139	146	14440A	191
102KM (BH)	144	128H	149	14012M	192	14440M	191
102KT	144	128T	149	1401A	233	14444AL	197
102NA	144	13012M	180	1401B	233	14455A	198
102NM	144	1301A	233	1401C	232	14465M	187
103KA	145	1301B	233	14025	192	14466A	198
103KM	145	1301C	232	1402A	233	144KM	245
103KT	145	13025	180	1402B	233	145KM-10H	146
10400A	224	1302A	233	1402C	232	145LH3/8F	250
10400M	224	1302B	233	141	132,269	14760	197
104A	138	1302C	232	14100A	131	14770	197
104M	138	13103M	133	14100M	131	14771	197
106	249	13105	180	14101M	259	14772-P	197,253
107-11	181,193,228,230	13105-11	180	14103M	133	148KM	245
107-11(T)	181,193,228,230	13105-11(T)	180	14105	192	149	232
107-11(XZN)	181,193,228,230	13137E	159	14105-11	194	14760	197
107-16	195,206,214	13137H	159	14105-11 (T)	194	14770	197
107-16(T)	195,206,214	13139	153	14105-11 (XZN)	194	14771	197
107-16(XZN)	195,206,214	13140	155	14105-L105	194	14772-P	197,253
107-22	207,215	13142-D6.3	153	14105-L105 (T)	194	150-10H	146
107-22(T)	207,215	13142-F6.3	159	14105L	192	150-14H	250
107-32	220	13145A	253	14106	195	1500A	233
108H	152	13145M	182	14112	259	1500B	233
108P	152	13145M (12P)	182,247	14113J	256	152	232
108S	152	13145MG	182	14113M	256	15300M	201
108T (T)	152	13146M	183	14118M	256	15310M	201
108T (TH)	152	13147M	183	14124	257	15400A	200
110	157	131P	156	14124/3	257	15400M	200
112	157	131PS	156	14137E	159	15410M	200
113	160,265	131S	156	14139	153	154K	250
113 (2B)	160	131T	156	14140	155	154M	145
113 (E)	160	13241M	184	14142-D6.3	153	154ML	145
113UN	162	13242M	184	14142-F6.3	159	155	254
115	161,265	13300A	177	14145A	253	15544A	201
115G	162	13300G	178	14145M	196	15555AL	201
117	157	13300M	177	14145PM	255	15566A	201
119	162	13300XG	177	14146M	196	156M	138
120	157	13301A	178	14147M	196	15770	201
1200A	233	13301M	178	141P	132,269	157H	140
1200B	233	13301X	177	141S	132,269	157P	140
1201	132,269	13305M	178	142	268	157S	140
1202	149	13310M	178	14201M	255	157T (T)	140
1203	146	13322A	184	14203M	198	158	249
1205	273	13333AL	184	14204M	198	1600C	232
1206	250	13344A	184	14204T	198	1601A	233
1210	251	13365M	179	14204X	198	1601B	233
1210E	251	13400A	173	14207M	199	1602A	233
1212	252	13400AG	175	14208M	199	1602B	233
12137E	159	13400M	173	14241M	199	160K	143
12139	153	13400MG	175	14242M	199	16101M	259
12140	155	13400-WN	176	14245M	199	16102M	260
12142-F6.3	159	13401A	174	14300A	189	16106	206
121H	158	13401LH	176	14300G	191	16106-16	206
121P	158	13401M	174	14300M	189	16107	207
121T (T)	158	13401MS	173	14301A	189	16107-22	207
121T (TH)	158	13405A	173	14301M	189	16201A	209
12222AL	172	13405M	173	14301X	188	16201M	209
12233A	172	13406A	174	14305M	190,253	16245M	209
12300G	172	13406M	174	14306M	190	162E	268
12300M	172	13410M	175	14310M	190	162RK	279
12365M	172	13425	175	14325	191	16300A	204
123PG	159,267	13425-EPL	175	14365M	191	16300M	204



16301A	205	18102M	260	2275	038	2753RK	276
16301M	205	18104M	213	2276	038	2755	032
16301X	204	18106	214	2277	038	2755RK	278
16305M	205,247	18106-16	214	2277A-12P	038	2756	032
16316A	262	18107	215	2285ZE	121	2756Z	121
16316M	262	18107-22	215	2300A	023	2756Z-3/8	121
16317A	262	18300A	212	2300M	023	2760	033
16317M	262	18300M	212	2300MZ	119	2760Z	121
16325	205	18301A	213	2300W-BA	023	2762	032
16400A	202	18301M	213	2300X	022	2763	033
16400M	202	18301X	212	2305A	023	2768J	033
16401A	203	18316A	262	2305M	023	2768N	033
16401M	203	18316M	262	2310M	024	2768P	033
16405A	202	18317A	262	2325	024	2768RK	278
16405M	202	18317M	262	23300A	238	2769F	034
16425	203	18400A	210	23300M	238	2769H	034
16425-EPL	203	18400M	210	23305M	238	2769N	034,168
165LM	159	18401A	211	23310M	238	2769NWF	034,168
16644A	208	18401M	211	23325	238	2770	035
16655A	208	18405A	211	23400A	237	2771	035
16666AL	208	18405M	211	23400M	237	2771Z	121
16688A	208	186	157	23405M	237	2774J	032
166P	166	18760	216	23410M	237	2774JS	031
166PS/6	166	18770	216	23425	237	2774JS-3/8	063
166S	166	18771	216	2350M	024	2774N	032
16760	207	18866A	217	23760	238	2774P	032
16770	208	18877A	217	2400A	020	2774P-1/4HF	153
16771	208	18888AL	216	2400M	020	2774P-5/16HF	155
167A	164	1901A	233	2400MZ	119	2774PS	031
167C (2B)	164	1901B	233	2400W-BA	021	2774PS-3/8	063
167M	164	1902A	233	2405A	020	2780	035
168C	167	1902B	233	2405M	020	2785	035
168CS	167	19300M	223	2410M	021	3000 (PH)	050
168H-B	165	19400A	222	2415A	022	3000 (PZ)	050
168P	167	19400M	222	2415M	022	3001	057
168P (PZ)	165	19760	223	2425	022	3005	050
168PS/6	167	19770	223	24300A	240	3006	057
168R	165	198	255	24300M	240	3010M	051
168S	167	19977A	223	24305M	240	3010MZ	123
168T (250)	252	2000 (PH)	026	2430M	026	3011M	052
168T (IP)	276	2000 (PZ)	026	2430T	026	3012A	058
168T (TH)	165	2000Z	120	24310M	240	3012M	058,249
168T/7 (TH)	165	2001A	233	24400A	239	3015M	052
169	252	2001B	233	24400M	239	3020	053
169/2	252	2002A	233	24405M	239	3025 (IP)	056
169BP	252	2002B	233	2440A	025	3025 (PR)	056
169HR	252	2005	026	2440M	025	3025 (T)	054
169WM	252	2005Z	120	2440T	025	3025 (TH)	055
1700C	232	2010A	027	24410M	239	3025-100R(T)	054
1701A	233	2010M	027	2441M	025	3025-100R(TH)	055
1701B	233	2010MZ	120	24425	239	3025Z	123
1702A	233	2011M	027	2445A	025	3027	057
1702B	233	2020	028	2445M	025	3110A	248
170S	272	2025 (IP)	029	2450MS	022	3110M	248
171	272	2025 (PR)	029	24760	240	3112G	150
17108	220	2025 (T)	028	2715	141	3112N	150
17108-32	220	2025 (TH)	028	2725RK	276	3112RK	279
171B-1/2	273	2025Z	120	2725Z	121	3116M	139
171S	272	2127	134	2725Z-3/8	124	3117M	050
171SB-1/2	273	2137	153	2726Z	121	3127	134
172	272	2138	155	2726Z-3/8	124	3128	135
17300A	219	2201AM	036	2749N-3/8	059	3129	136
17300M	219	2203A	036	2749P-1/4HF	153	3131A	143
17400A	218	2203M	036	2749P-3/8	059	3132	143
17400M	218	22300A	236	2749P-5/16HF	155	3137	153
17405A	219	22300M	236	2749PS-3/8	059	3138	155
17405M	219	2233A	035	2749RK	276	3141	156
17760	221	22400M	236	2749RK-3/8	276	3200A	071
17770	221	22425	236	2752N	031	3200M	071
17788A	221	2250A	036	2752RK	276	3201AMW	071
17799A	221	2250M	036	2753BRK	276	3206A	071
1801A	233	2254M	036,149	2753J	030	3206AM	071
1801B	233	2257M	037	2753JB	031	3206M	071
1801C	232	2260M	037	2753N	030	3210M	072
1802A	233	2261M	037	2753NB	031	3215A	072
1802B	233	2262M	037	2753P	030	3215M	072
1802C	232	2274A	037	2753PB	031	3217M	072
18101M	259	2274M	037	2753PS	030	3220M	072

# Numerical Index

3221M	072	3726Z	124	4100A	130	4400LH	077
3225A	244	3726ZS	124	4100ARK	279	4400M	075
3240M	073	3749BRK	276	4100M	130	4400M-DU	254
3244	072	3749N	059	4100MRK	279	4400W	076
3247	055,251	3749RK	276	4101	254	4405A	075
3250M	073	3749S	059	4102	249	4405M	075
3252M	073	3749S-1/2	088	4103M	133	4405M-DU	254
3275	074	3749SB	059	4104	132	4405W	076
3276	074	3749SB-1/2	088	4109M	248	4410M	076
3277	074	3749SBRK-1/2	277	4110A	248	4425	076
3279AM	074	3749SRK-1/2	277	4110M	248	4425-EPL	077
3285Z	126	3751J	244	4111M	248	4425-N	077,253
3285ZA	126	3751N	244	4112G	150	4433A	097
3285ZE	126	3752J	060	4112N	150	4440A	080
3300A	044	3752N	060	4112RK	279	4440M	080
3300C	242,243	3752RK	276	4117M	081	4440T	080
3300CB	242	3753BRK	276	4122	246	4450M	077
3300CZ	123	3753J	061	4127	135	4466A	097
3300FN	047,246	3753JB	062	4128	135	4711X	142,255
3300M	044	3753N	061	4129	137	4715	142
3300M (L120)	045	3753NB	062	4132	143	4715S	142
3300M/4-L120	045,251	3753P	061	4133	246	4715SL	142
3300MZ	122	3753PB	062	4137	153	4747	097
3300S	242	3753RK	276	4138	155	4749J	088
3300W	046	3753SM	061	4141	156	4749N	088
3300X	043	3753SMB	062	4202	249	4749RK	277
3300XA	043	3755	066	4203M	133	4750BRK	277
3305A	044	3755RK	278	4203MF	133	4750J	089
3305M	044	3756	066	4211A	130	4750JB	089
3305M (L120)	045	3756Z	125	4211M	130	4750N	089
3305M/4-L120	045	3757	066	4214M	130	4750NB	089
3305P	242,243	3760	067	4222M	098	4750P	089
3305W	046	3760Z	125	4223M	098	4750PB	089
3305X	043	3762	066	4227M	098	4750RK	277
3305XA	043	3763	067	4230A	098	4752J	090
3310M	045	3768J	068	4230M	098	4752N	090
3322A	070	3768N	068	4232M	098	4752RK	277
3322AZ	125	3768P	068	4238AM	100	4753BRK	277
3325	046	3768RK	278	4240A	099	4753J	090
3340C	243	3768Z	125	4240M	099	4753JB	091
3340M	049	3768ZRK	278	4241A	100	4753N	090
3341G	245	3769H	069	4241M	100	4753NB	091
3342G	245	3769N	069,168	4244A	100	4753P	090
3344A	070	3769NWF	069,168	4244M	100	4753PB	091
3350M	047	3770	069	4248M	101	4753RK	277
3350M (L120)	047	3771	069	4250M	101	4755	095
3350M/2-L120	047,251	3771Z	125	4251A	101	4755RK	278
3400A	040	3774J	063	4251M	101	4756	095
3400LH	043	3774JB	064	4252A	101	4760	096
3400M	040	3774JBL	065	4252M	101	4763	096
3400MZ	122	3774JL	065	4254	101	4768J	094
3400W	041	3774N	063	4261M	102	4768N	094
3405A	040	3774NB	064	4263M	102	4768P	094
3405M	040	3774NL	065	4273AM	102	4768RK	278
3405W	041	3774P	063	4275	103	4770	095
3410M	041	3774PB	064	4276	103	4771	095
3415A	041	3774PL	065	4277	103	4774J	092
3415M	041	3774PS	063	4279AM	103	4774JB	093
3425	042	3774P-SR	064	4282	250	4774N	092
3425 (2B)	042	3776J	060	4289M	103	4774NB	093
3430M	049	3776N	060	4300A	078	4774P	092
3440A	048	3776P	060	4300C	242	4774PB	093
3440M	048	3780	070	4300H	247	4780	096
3440T	048	3785	070	4300H (8P)	247	4781N	095
3441M	049	4000 (PH)	081	4300M	078	4785	097
3445A	048	4000 (PZ)	081	4300M (L60)	255	4788	097
3445M	048	4001	081	4300M (L110)	255	6012M	105
3445W	048	4005	081	4300M (L120)	079	6100M	131
3450M	042	4006	081	4300S	242	6100MRK	279
3701	244	4010M	082	4300TW	273	6101	254
3715	141	4010M (12P)	247	4305A	078	6102M	260
3715S	141	4012A	087	4305M	078	6112	150
3715SL	141	4012M	086,086	4310M	079	6112RK	279
3715SLK	141	4020	083	4325	079	6201A	110
3716	141	4020 (MH)	248	4325 (L140)	080	6201M	110
3725RK	276	4025 (IP)	085	4325 (L140)-2B	080	6212A	110
3725Z	124	4025 (T)	084	4340C	243	6212M	110
3725ZS	124	4027	085	4400A	075	6260A	111

6260M	111	BD022	157	RS2010M/7-L25	027	RS3405M/8	040
6268M	111	BD023E	267	RS2025/7-HOLE	028	RS3405M/12	040
6300A	105	BD024E	267	RS2025/7-IP	029	RS3405W/7	041
6300M	105	BD14400MJ	270	RS2025/7-L28	028	RS3410M/12	041
6305A	105	CLIP.P/5-1/2	126	RS2025/7-PR	029	RS3425/4 (2B)	042
6305M	105	CLIP.P/5-1/4	126	RS2025Z/7-L28	120	RS3425/9	042
6400A	104	CLIP.P/5-3/8	126	RS20XXZ/9	120	RS3430M/6	049
6400M	104	D3753J	061	RS2127/10	134	RS3440A/8	048
6405A	104	D4753J	090	RS2127/6	134	RS3440M/8	048
6405A-MV	254	HA001	271	RS2300A/9	023	RS3440T/8	048
6405M	104	HA002	271	RS2300M/11	023	RS3441M/5	049
6644A	109	HA003	271	RS2300MZ/12	119	RS3445W/7	048
6688A	109	HA004	271	RS2300X/11	022	RS3450M/8	042
6749	106	KP14101	258	RS2305A/9	023	RS3450M/10	042
6749RK	277	KP14101/6H	258	RS2305M/11	023	RS300MZ/12	122
6752	106	KP14101/6S	258	RS2310M/11	024	RS4010M/10	082
6752RK	277	NV13105	228	RS2400A/9	020	RS4012A/10	087
6755	107	NV13145	227	RS2400M/11	020	RS4012M/10	086
6755RK	278	NV13400	227	RS2400MZ/12	119	RS4020/6	083
6760	107	NV13760	227	RS2400W/9-BA	021	RS4025/9 (IP)	085
6768	108	NV14105	230	RS2405A/9	020	RS4025/9 (T)	084
6768RK	278	NV14145	229	RS2405M/11	020	RS4027/6	085
6770	109	NV14400	229	RS2410M/11	021	RS4127/6	135
6785	108	NV14433A	229	RS2425/6	022	RS4129/5	137
6788	108	NV14760	229	RS2445A/9	025	RS4300A/10	078
8012M	113	NV16400	231	RS2450MS/6	022	RS4300M/10	078
8102M	260	NV16760	231	RS3010M/8	051	RS4305A/10	078
8200A	116	P2201AM	039	RS3010MZ/8	123	RS4305M/10	078
8200M	116	P2251M	039	RS3012A/8	058	RS4310M/10	079
8225M	116	P2258M	039	RS3012M/8	058	RS4325/7	079
8400A	112	P2281A	039	RS3015M/8	052	RS4400A/10	075
8400M	112	P2285Z	121	RS3020/6	053	RS4400LH/6	077
8405A	112	P3262M	073	RS3020/7	053	RS4400M/10	075
8405M	112	P4241M	102	RS3025/8 (IP)	056	RS4400W/8	076
8749	114	PK1301C	232	RS3025/8 (T)	054	RS4405A/10	075
8749RK	277	PK1302C	232	RS3025/8-L100R	054	RS4405M/10	075
8760	113	PK1401C	232	RS3025/8-L100RH	055	RS4405W/8	076
8768	114	PK1402C	232	RS3025/9 (PR)	056	RS4410M/10	076
8768RK	278	PK1600C	232	RS3025/9 (TH)	055	RS4425/6-EPL	077
8770	113	PK166PS/6	166	RS3025Z/8	123	RS4425/6-N	077,253
8785	114	PK168PS/6	167	RS3027/5	057	RS4425/7	076
8788	114	PK1801C	232	RS3127/8	134	RS4450M/10	077
8866A	113	PK2346/6	070	RS3129/6	136	RSAL-200	126
AG112A	151	PK2760/6	033	RS3300A/9	044	RSAL-300	126
AG112F	151	PK2763/6	033	RS3300FN/6	047,246	RSAL200-1/4x12	126
AG112H	151	PK3760/6	067	RS3300M/8	044	RSAL200-3/8x8	126
AG318A	151	PK3763/6	067	RS3300M/12	044	RSAL300-1/2x10	126
AL4400M	256	PK4760/5	096	RS3300MZ/8	122	RSAL300-3/8x12	126
AN112A	151	PK4763/5	096	RS3300MZ/12	122	RSAS2305A/10	024
AN112C	151	PW6	261	RS3300W/7	046	RSAS2405A/10	021
AN14300	256	PW8	261	RS3300X/8	043	RSX025/11 (IP)	056
AN318A	151	PW8L	261	RS3300XA/9	043	RSX025/11 (PR)	056
ANBD007E	265	PW8P	261	RS3305A/9	044	S14240M	199
AR14300	256	PW8P/4	261	RS3305M/8	044	S3240A	073
AS2305A	024	R810	145	RS3305M/12	044	S3240M	073
AS2405A	021	R810A	147	RS3305W/7	046	S4240A	099
AS2445A	025	R810B	147	RS3305X/8	043	S4240A	099
BD003E-I	266	R810C	147	RS3305XA/9	043	SP4300M	246
BD004	268	R810D	147	RS3310M/12	045	SP4305M	246
BD008E (12P)	264,266	R810E	147	RS3325/9	046	ST4027	247
BD011SE	265	RS13025/8	180	RS3340M/8	049	TI4261M	128
BD013E	266	RS13301X/9	177	RS3350M/5	047		
BD014E	264	RS13401M/9	174	RS3400A/9	040		
BD014SE	264	RS13401MS/5	173	RS3400LH/7	043		
BD016E	270	RS14012M/10	192	RS3400M/8	040		
BD016E (SF)	270	RS14025/6	192	RS3400M/12	040		
BD016JE	270	RS14124/7	257	RS3400MZ/8	122		
BD016JE (SF)	270	RS14301X/10	188	RS3400MZ/12	122		
BD017E	266	RS14401M/10	186	RS3400W/7	041		
BD018	266	RS2010A/8-L25	027	RS3405A/9	040		

Reproduction in whole or in part without proper and prior authorization is prohibited.  
Prohibida la reproducción total o parcial sin la debida autorización previa.

本商品目錄之全部版權,係歸於株式會社山下工業研究所(Kokon TOOL CO.,LTD.)所有,不論其部分或全部,未經本公司許可,均不得複製

***Koken***<sup>®</sup>

